

CipherLab Reference Manual

RS35 Mobile Computer
Android™ 10

Version 1.00



Copyright © 2020 CIPHERLAB CO., LTD.
All rights reserved

The software contains proprietary information of its owner; it is provided under a license agreement containing restrictions on use and disclosure and is also protected by copyright law. Reverse engineering of the software is prohibited.

Due to continued product development, this information may change without notice. The information and intellectual property contained herein is confidential between the owner and the client and remains the exclusive property of the owner. If having any problems in the documentation, please report them to us in writing. The owner does not warrant that this document is error-free.

No part of this publication may be reproduced, stored in a retrieval system, or transmitted in any form or by any means, electronic, mechanical, photocopying, recording or otherwise without the prior written permission of the owner.

For product consultancy and technical support, please contact the local sales representative. Also, visit our website for more information.

All brand, logo, product and service, and trademark names are the property of their registered owners.

Google, Android, Google Play and other marks are trademarks of Google LLC.

The editorial use of these names is for identification as well as to the benefit of the owners, with no intention of infringement.

CIPHERLAB logo is a registered trademark of CIPHERLAB CO., LTD. All other brands, products and services, and trademark names are the property of their registered owners. The editorial use of these names is for identification as well as to the benefit of the owners, with no intention of infringement.

CIPHERLAB CO., LTD.
Website: <http://www.CipherLab.com>

IMPORTANT NOTICES

FOR USA

This equipment has been tested and found to comply with the limits for a **Class B** digital device, pursuant to Part 15 of the FCC Rules. These limits are designed to provide reasonable protection against harmful interference in a residential installation. This equipment generates, uses and can radiate radio frequency energy and, if not installed and used in accordance with the instructions, may cause harmful interference to radio communication. However, there is no guarantee that interference will not occur in a particular installation. If this equipment does cause harmful interference to radio or television reception, which can be determined by turning the equipment off and on, the user is encouraged to try to correct the interference by one or more of the following measures:

- ▶ Reorient or relocate the receiving antenna.
- ▶ Increase the separation between the equipment and receiver.
- ▶ Connect the equipment into an outlet on a circuit different from that to which the receiver is connected.
- ▶ Consult the dealer or an experienced radio/TV technician for help.

This device complies with Part 15 of the FCC Rules. Operation is subject to the following two conditions: (1) This device may not cause harmful interference, and (2) this device must accept any interference received, including interference that may cause undesired operation.

FCC Caution:

Any changes or modifications not expressly approved by the party responsible for compliance could void the user's authority to operate this equipment.

This transmitter must not be co-located or operating in conjunction with any other antenna or transmitter.

Find the certificate information from:

Setup → About Phone → Regulatory information



Tested to Comply with FCC Standards

FOR HOME OR OFFICE USE

FOR PRODUCT WITH LASER

- ▶ This laser component emits FDA / IEC Class 2 laser light at the exit port. Do NOT STARE INTO BEAM DIRECTLY.
- ▶ Do not aim the beam at the eyes.
- ▶ Any adjustments or performance excluding those specified herein may result in hazardous laser light exposure.



ENVIRONMENT

- ▶ Operate the mobile computer at ambient temperatures from -20°C to 50°C and with humidity range from 10% to 90%.
- ▶ Store the device at ambient temperatures from -30°C to 70°C and with humidity range from 5% to 95%.
- ▶ Charge the device at ambient temperatures from 0°C to 40°C.
- ▶ This device is built with a dust-proof and splash-proof structure that conforms to protection class IP65/ IP67.

SPECIFIC ABSORPTION RATE (SAR) INFORMATION

▶ USA

This device meets the government's requirements for exposure to radio waves. This device is designed and manufactured not to exceed the emission limits for exposure to radio frequency (RF) energy set by the Federal Communications Commission of the U.S. Government.

The exposure standard employs a unit of measurement known as the Specific Absorption Rate, or SAR. The SAR limit set by the FCC is 1.6 W/kg. Tests for SAR are conducted using standard operating positions accepted by the FCC with the EUT transmitting at the specified power level in different channels.

The FCC has granted an Equipment Authorization for this device with all reported SAR levels evaluated as in compliance with the FCC RF exposure guidelines. SAR information on this device is on file with the FCC and can be found under the Display Grant section of www.fcc.gov/eot/ea/fccid after searching on FCC ID: Q3N-RS35

▶ Canada

The radiated output power of the Wireless Device is below the Innovation, Science and Economic Development Canada (ISED) radio frequency exposure limits. The Wireless Device should be used in such a manner such that the potential for human contact during normal operation is minimized.

This device has been evaluated for and shown compliant with the ISED Specific Absorption Rate ("SAR") limits when operated in portable exposure conditions.

This device contains licence-exempt transmitter(s)/receiver(s) that comply with Innovation, Science and Economic Development Canada's licence-exempt RSS(s). Operation is subject to the following two conditions:

- (1) This device may not cause interference.
- (2) This device must accept any interference, including interference that may cause undesired operation of the device.

La puissance de sortie rayonnée du dispositif sans fil est inférieure aux limites d'exposition aux radiofréquences d'Innovation, Sciences et Développement économique Canada (ISED). Le dispositif sans fil doit être utilisé de manière à minimiser le potentiel de contact humain pendant le fonctionnement normal.

Cet appareil a été évalué et montré conforme aux limites de DAS (Débit d'Absorption Spécifique) de l'ISED lorsqu'il est utilisé dans des conditions d'exposition portables.

L'émetteur/récepteur exempt de licence contenu dans le présent appareil est conforme aux CNR d'Innovation, Sciences et Développement économique Canada applicables aux appareils radio exempts de licence. L'exploitation est autorisée aux deux conditions suivantes :

- (1) L'appareil ne doit pas produire de brouillage;
- (2) L'appareil doit accepter tout brouillage radioélectrique subi, même si le brouillage est susceptible d'en compromettre le fonctionnement.

▶ **Europe**

A minimum separation distance of 0.5 cm must be maintained between the user's body and the device, including the antenna during body-worn operation to comply with the RF exposure requirements in Europe.

To compliance with RF Exposure requirements in Europe, third-party belt-clips, holsters or similar accessories used by this device should not contain any metallic components. The use of accessories that do not satisfy these requirements may not comply with RF exposure requirements, and should be avoided.

CE SAR Value (Standard limit is 2 W/Kg)

EU (10g): Max. 1.440 W/Kg

▶ **DoC**

Hereby, CIPHERLAB CO, declares that this RS35 is in compliance with the essential requirements and other relevant provisions of Directive 2014/53/EU.

URL: www.cipherlab.com

Indoor restriction: In EU, 5150 to 5350MHz is restricted indoor.

IMPORTANT SAFETY INSTRUCTIONS AND WARNINGS FOR LI-ION/POLYMER BATTERY

- ▶ It is important for users to be aware of the risks associated with lithium batteries.
- ▶ Lithium Polymer and Li-ion batteries are volatile. Failure to read and follow the below instructions may result personal injury and damage to device if charged or used improperly.
- ▶ Lithium Polymer/Li-ion batteries have limited life cycle for charging and discharging. When life cycle has been reached, battery may swell.
- ▶ Must keep Lithium Polymer and Li-ion battery away from children.
- ▶ Never make wrong polarity connection when charging and discharging battery. Always double check polarity of battery's connector.
- ▶ If battery has not been using or staying in device for 2 months, please do battery complete discharging and charging once before use. Always detach battery from device if you will not use device for long period of time.

CAUTION

RISK OF EXPLOSION IF BATTERY IS REPLACED BY AN INCORRECT TYPE.

DISPOSE OF USED BATTERIES ACCORDING TO THE INSTRUCTIONS

- ▶ Disposal of a battery into fire or a hot oven, or mechanically crushing or cutting of a battery, that can result in an explosion;
- ▶ leaving a battery in an extremely high temperature surrounding environment that can result in an explosion or the leakage of flammable liquid or gas;
- ▶ a battery subjected to extremely low air pressure that may result in an explosion or the leakage of flammable liquid or gas.

GENERAL GUIDELINE AND WARNING

- ▶ Use specific Lithium Polymer/Li-ion charger from CipherLab only. Failure to do so may cause fire, which may result in personal injury and property damage.
- ▶ Never charge batteries unattended. When charging Lithium Polymer/Li-ion batteries, you should always remain in constant observation to monitor the charging process and react to potential problems that may occur.
- ▶ Some Polymer/Li-ion chargers on the market may have technical deficiencies that may cause it to charge the LiPo/Li-ion batteries incorrectly or at an improper rate. Assure the charger you purchased works properly and always monitor charging process to ensure batteries are being charged properly. Failure to do so may result in fire.
- ▶ If at any time you witness a battery starting to balloon, swell up, smoke or hot; stop using this battery at once and contact your dealer immediately.
- ▶ If you accidentally short the battery polarity, the battery must be placed in a safe area for observation for approximately 15 minutes. Additionally, if a short occurs and contact is made with metal (such as rings on your hand), severe injuries may occur due to the conductivity of electric current.
- ▶ In the event of a crash due to bad shipment or other reasons, you must remove damaged battery for observation and place the damaged batteries from other good batteries.
- ▶ Never drop the batteries.
- ▶ Do NOT expose battery to water.
- ▶ Do NOT attempt to dis-assemble battery.
- ▶ Recommended to put the battery in an enclosure to protect it from damages by liquid or dropping from height accidentally.

CHARGING PROCESS

- ▶ Please ensure to charge battery indoor such as a well-ventilated room between 20°C to 30°C.
- ▶ Do NOT charge battery under direct sunlight.
- ▶ When selecting the cell count or voltage for charging purposes, select the cell count and voltage as it appears on the battery label. As a safety precaution, please confirm the information printed on the battery is correct.
- ▶ Lithium Polymer/Li-ion batteries has limited life cycle for charging and discharging. When life cycle has been reached, battery may swell.
- ▶ The allowed charging temperature is from 0°C to 40°C.
- ▶ During discharge and handling of batteries, do not exceed 50°C.

STORAGE & TRANSPORTATION

- ▶ CipherLab battery is charged in manufacturing to around 30% of its full capacity. It is a good capacity for long-term storage & transportation.
- ▶ Battery should NOT be stored in full-charged or full-discharge state; otherwise it will damage battery permanently.
- ▶ Battery subjects to discharge even when not installed in a device. For any stored & unused battery, it is highly recommended for every 3 months to charge battery to 40%~60% of its original capacity to prolonged storage.
- ▶ Always detach battery from device if you will not use device for long period of time.
- ▶ Store battery indoor temperature between 0°C to 30°C for the best performance.
- ▶ Do NOT store battery in temperature exceeding 50°C, and never expose battery pack to high external pressure for extended periods, which can lead to an internal short circuit and overheating.
- ▶ When transporting or temporarily storing in a vehicle, temperature range should be greater than 0°C but no more than 45°C.
- ▶ Storing battery at temperatures greater than 50°C for extended periods of time (more than 2 hours) may cause damage to battery.

TO USE, HANDLE, AND DISPOSE BATTERY

- ▶ For Li-ion / Li-polymer battery, it is normal to balloon, expand, or swell after one year or 500 cycles (full charge-discharge cycles). Although we guarantee it will NOT cause any damage, it can't be used again and must be disposed at once, therefore we strongly recommend to replace battery every year or after 500 cycles, depend on which comes first.
- ▶ If a battery performance decreases more than 20%, it means the battery is at the end of its life cycle. Please stop using this battery, dispose properly according to the location's safe battery disposal procedures, and replace with a new / healthy one.
- ▶ The actual number of charge cycle will vary depending on usage conditions, patterns, ambient temperature, and other variables.
- ▶ Deep discharge below 3V can deteriorate battery performance.
- ▶ Use caution to avoid puncture of the battery. Puncture of battery may damage battery cell.
- ▶ Periodically and properly dispose used battery according to local regulations.

PRODUCT WARRANTY

Product warranty is limited to original manufacturing defects in material only. Warranty will not apply to batteries with reduced capacity due to user scenario, unless determined to be a manufacturing flaw.

Warranty does not cover collateral damage. Due Misuse, abuse, incorrect charging and other inappropriate use of this product are not covered under warranty.

SAFETY PRECAUTIONS



Warning statement:

A pleine puissance, l'écoute prolongée du baladeur peut endommager l'oreille de l'utilisateur.

To prevent possible hearing damage, do not listen at high volume levels for long periods.

RISK OF EXPLOSION IF BATTERY IS REPLACED BY AN INCORRECT TYPE. DISPOSE OF USED BATTERIES ACCORDING TO THE INSTRUCTIONS.

For people's safety

- ▶ Do not listen at high volume levels for long periods to prevent possible hearing damage.
- ▶ Do not operate this device while walking, cycling or car driving.

For the equipment

- ▶ Do not use any batteries or charging devices which are not originally sold or manufactured by CIPHERLAB CO., LTD.
- ▶ Do not replace the battery with an incorrect type, to avoid the risk of heat generation, fire, or explosion.
- ▶ Do not disassemble, incinerate or short circuit the battery.
- ▶ Do not touch the contact pins of the battery pack.
- ▶ Do not expose the mobile computer or battery to any flammable sources.
- ▶ Do not expose the mobile computer to extreme temperatures or soak it in water.
- ▶ Do not use any pointed or sharp objects against the screen surface.
- ▶ Do not use the styluses which are not supplied or approved by CIPHERLAB CO., LTD., to prevent possible scratches to the touch screen.
- ▶ Water residue on the touch screen may cause abnormal behaviors or the fall of its sensitivity levels.
- ▶ On the surface of the terminal and the barcode reading window, the fog or water drops caused by low temperatures may influence barcode reading.
- ▶ Do not use bleaches or cleaners to clean the device. Use a clean, wet cloth instead.

BATTERY

- ▶ The main battery may not be charged to full for shipment. Charge the main battery to full before using the mobile computer for the first time.
- ▶ **Main battery:** The main battery powers the mobile computer to work. It takes approximately 4 hours to charge an empty main battery to full. For the first time charging the main battery, please charge it for at least 8 to 12 hours. The charging LED above the screen will light up in red while charging and will turn green when charging is complete.
- ▶ **Backup battery:** The backup battery is mounted on the main board. Its role is to temporarily keep the mobile computer in suspension when the main battery is drained out so data in DRAM will be retained. The backup battery can be charged by the main battery or the power adapter, and takes approximately 4 hours to charge to full under the condition that it is always be charged except of power off.
- ▶ **RTC battery:** RTC battery is a 3V, 1mAh rechargeable SMT type Li-battery which takes about 12 hours to be fully charged. RTC retention will be maintained for at least 72 hours when the main battery is removed.
- ▶ The allowed battery charging ambient temperature is between 0°C to 40°C. It is recommended to charge the battery at room temperature (18°C to 25°C) for optimal performance.
- ▶ Please note that battery charging stops when ambient temperature drops below 0°C or exceeds 40°C.
- ▶ In order to prevent system from shutting down after the battery is drained out, keep a fresh battery for replacement at all times, or connect the mobile computer to an external power.
- ▶ If there are drippings or dust on the device or battery pack, wipe them away with a soft clean cloth before battery replacement.
- ▶ Turn off the power before main battery replacement (except of battery hot swap at the available temperature rang 0°C to 50°C).
- ▶ If you want to put away the mobile computer for a period of time, remove the battery pack from the mobile computer's battery compartment. Store the mobile computer and battery pack separately.
- ▶ Recycle batteries in a proper way for the green-environment issue.

SCANNER

▶ Scan a 1D barcode

- 1) Open **ReaderConfig** and tap **Scan Test** on the menu bar.
- 2) Aim the scanning window at the barcode to read. Move the device, having the barcode located in the center of the scanning area.
- 3) Press any of the two side triggers. The scanning light beams to read the printed barcodes. The buzzer beeps after scanning. The scanning light goes off once the data is decoded, or when the decode timeout period has passed.

▶ Scan a 2D barcode

- 1) Open **ReaderConfig** and tap **Scan Test** on the menu bar.
- 2) Aim the scanning window at the barcode to read. Move the device, having the barcode located in the center of the scanning area.
- 3) Press any of the two side triggers. The scanning light beams to read the printed barcodes. The buzzer beeps after scanning. The scanning light goes off once the data is decoded, or when the decode timeout period has passed.

CONNECTION

Via Bluetooth or WLAN

- ▶ Connection may fail when the mobile computer is around other wireless machines or power cables as the radio frequencies of those may cause interferences.
- ▶ If communication fails, move the devices much closer to each other, and try to communicate again
- ▶ After turning on, Bluetooth power is sustained even when the mobile computer is suspended. However, if the power mode is switched to Airplane Mode, Bluetooth power will be turned off regardless of the settings.

To a Charging & Communication Cradle

- ▶ Do not insert the mobile computer to a Charging & Communication Cradle if water or drippings are staying on the device.
- ▶ The LED indicator on a Charging & Communication Cradle shows the status of battery charging only; the status of terminal charging is shown on the device itself.
- ▶ Not Charging could be the result of battery damage, battery's failure to touch the connector or AC plug coming off.
- ▶ Charging error could be due to high battery temperature.

CARE & MAINTENANCE

- ▶ This mobile computer is intended for industrial use. The mobile computer is rated IP65 /IP67, however, damage may be done to the mobile computer if it is exposed to extreme temperatures or soaked in water.
- ▶ When the body of the mobile computer gets dirty, use a clean, wet cloth to wipe off dust and debris. DO NOT use bleaches or cleaners.
- ▶ Use a clean, non-abrasive, lint-free cloth to wipe dust off the LCD touch screen. DO NOT use any pointed or sharp objects against the surface. Always keep the LCD dry.
- ▶ If you want to put away the mobile computer for a period of time, download the collected data to a host computer, and then remove the battery pack from the mobile computer's battery compartment. Store the mobile computer and battery pack separately.
- ▶ If you encounter malfunction on the mobile computer, write down the specific scenario and consult your local sales representative.

E-LABEL

Mobile Computer 行動電腦

Model : RS35



INPUT

5V , 2A

US

FCC ID : Q3N-RS35



This device complies with Part 15 of the FCC Rules.
Operation is subject to the following two conditions:
(1) This device may not cause harmful interference, and
(2) this device must accept any interference received,
including interference that may cause undesired operation.

CA

IC : 5121A-RS35

Complies with Canadian ICES-003 Class B.
Conforme a la NMB-003 classe B du Canada.

This device complies with ISED's licence-exempt RSSs.
Operation is subject to the following two conditions :
(1) This device may not cause harmful interference, and
(2) this device must accept any interference received,
including interference that may cause undesired operation.

TW

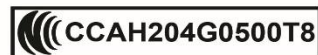

減少電磁波影響,請妥適使用

IN

IS 13252(PART1)/
IEC60950-1



R-41077615
www.bis.gov.in



R 020-200136

T ADF200051020

電波法により W52, W53 は屋内使用限定

Made in Taiwan

CE DECLARATION



Declaration of Conformity

Manufacturer

CIPHERLAB Co., Ltd.
 12F., 333, Dunhua S. Rd., Sec. 2
 Taipei, Taiwan 106, R.O.C.
 Tel: +886 2 8647 1166
<http://www.cipherlab.com>

Type of Equipment

Mobile Computer

Model(s) Declared

RS35

Initial Year of Manufacture **2020**

Reference to the specification under which conformity is declared in accordance with Council Directive- 2014/30/EU(EMC), 2014/35/EU(LVD), 2014/53/EU (RED).

EN 300 328 V2.2.2	EN 301 489-1 V2.2.3
EN 303 413 V1.1.1	EN 301 489-3 V2.1.1
EN 301 511 V12.5.1	EN 50566:2017
EN 301 908-2 V11.1.2	EN 61000-3-3 :2013
EN 300 330 V2.1.1	EN 301 489-52 V1.1.0
EN 50360 :2017	EN 301 489-17 V3.1.1
EN 61000-3-2 :2014	EN 301 489-19 V2.1.1
EN 55035 : 2017	EN 301 908-1 V13.1.1
EN 55032: 2015+AC:2016	EN 62479:2010
EN 60950-1 : 2006+A2:2013	EN 301908-13 V13.1.1
EN 301 893 V2.1.1	

I the undersigned, hereby declare that the equipment specified above conforms to the above Directive(s) and Standard(s).

Manufacture Signature

Full Name :Herbie Jiang

Title : Manager

Date: 2020.08.13

THAILAND CAUTION

เครื่องโทรคมนาคมและอุปกรณ์นี้มีความสอดคล้องตามมาตรฐานหรือข้อกำหนดของกสทช.



เครื่องวิทยุคมนาคมนี้มีอัตราการดูดกลืนพลังงานจำเพาะ (Specific Absorption Rate - SAR) อันเนื่องมาจากเครื่องวิทยุคมนาคมเท่ากับ 1.440 W/kg ซึ่งสอดคล้องตามมาตรฐานความปลอดภัยต่อสุขภาพของมนุษย์จากการใช้เครื่องวิทยุคมนาคมที่คณะกรรมการกิจการโทรคมนาคมแห่งชาติประกาศกำหนด

RELEASE NOTES

Version	Date	Notes
1.00	Nov. 5, 2020	Initial release

CONTENTS

- IMPORTANT NOTICES..... - 1 -**
 - For USA - 1 -
 - For Product with Laser - 2 -
 - Environment - 2 -
 - Specific Absorption Rate (SAR) information - 2 -
 - Important Safety Instructions and Warnings for Li-ion/Polymer Battery..... - 4 -
 - General Guideline and Warning - 5 -
 - Charging Process - 5 -
 - Storage & Transportation - 6 -
 - To Use, Handle, and Dispose Battery - 6 -
 - Product Warranty - 7 -
 - Safety Precautions - 8 -
 - Battery..... - 9 -
 - Scanner..... - 10 -
 - Connection..... - 10 -
 - Care & Maintenance - 11 -
 - E-Label - 12 -
 - CE Declaration..... - 13 -
 - Thailand Caution - 14 -
- RELEASE NOTES - 15 -**
- INTRODUCTION 20**
 - Features..... 21
 - Inside the Package..... 21
 - Accessories..... 21
 - Related Documentation..... 22
- QUICK START 23**
 - 1.1. Overview 24
 - 1.1.1. Install/ Remove Battery 26
 - 1.1.2. Installing SIM Card, SAM Card and Memory Card 29
 - 1.1.3. Power On/Off Mobile Computer 32
 - 1.2. Charging & Communication 33
 - 1.2.1. Charge Mobile Computer 33
 - 1.2.2. Wired Data Transmission 40
 - 1.2.3. Using Wireless Networks..... 41

USING RS35 MOBILE COMPUTER	42
2.1. Battery	43
2.1.1. Battery Status Indicators.....	44
2.1.2. Monitor Battery Level	46
2.1.3. Replace Main Battery.....	52
2.1.4. Power Management	54
2.1.5. Battery Precautions	56
2.2. Memory	59
2.2.1. Check Memory Usage.....	60
2.2.2. Manage Storage Space.....	62
2.3. Touch Screen	71
2.3.1. Screen Brightness	71
2.3.2. Screen rotation	72
2.3.3. Screen Timeout Settings.....	76
2.3.4. Text Size & Display Size	77
2.4. Notifications.....	78
2.4.1. Status LED	78
2.4.2. Audio.....	78
2.4.3. Sounds and Vibration	79
2.5. Date and Time	83
2.6. Language & Keyboard Input	85
2.6.1. Change Display Language.....	85
2.6.2. On-screen Keyboard.....	87
2.7. Enterprise Settings	89
2.8. Sound and Volume	90
2.9. Data Capture.....	91
2.9.1. Barcode Reader.....	91
2.9.2. Digital Camera	91
BASIC OPERATION	92
3.1. Home Screen	93
3.1.1. Application & Widget on Home Screen	94
3.1.2. Folder on Home Screen.....	96
3.2. Navigation Method	97
3.2.1. Change the Navigation Method	97
3.2.2. Recently Used Applications.....	100
3.3. Status Bar	101
3.3.1. Icons on Status Bar	101
3.3.2. Open Quick Setting Menu	103
3.3.3. Open Notifications Drawer.....	106

3.4.	Suspend & Lock.....	109
3.4.1.	Suspend Device.....	109
3.4.2.	Lock Device.....	110
3.5.	OS Update.....	112
3.5.1.	Network Update.....	112
3.5.2.	SD Card Update.....	114
3.6.	Back up Your Data.....	115
3.7.	Reset to Factory Default.....	117
3.7.1.	Erase All Data (Factory Reset).....	117
3.7.2.	Erase All Date (Factory Reset with Enterprise).....	119
3.7.3.	Welcome Wizard.....	120
WIRELESS RADIOS.....		123
4.1.	Use Wireless Local Area Network (Wi-Fi).....	124
4.1.1.	Connect to Wi-Fi Network.....	124
4.1.2.	Manually Add Wi-Fi Network.....	126
4.1.3.	Advanced Wi-Fi Settings.....	128
4.1.4.	Modify Wi-Fi Network.....	130
4.1.5.	Disconnect Wi-Fi Network.....	132
4.2.	Use Bluetooth.....	133
4.2.1.	Bluetooth Profiles.....	133
4.2.2.	Turn On Bluetooth.....	134
4.2.3.	Change Bluetooth Name.....	136
4.2.4.	Pair Bluetooth Devices.....	137
4.2.5.	Unpair Bluetooth Device.....	138
4.3.	Use Near Field Communications.....	139
USING THE PHONE.....		141
5.1.	SIM Card Management.....	142
5.2.	Phone Application.....	144
5.2.1.	Phone Interface.....	145
5.2.2.	Place Call.....	147
5.2.3.	During A Call.....	148
5.2.4.	Receive Incoming Call.....	149
5.2.5.	Check Missed Calls.....	149
5.2.6.	Call History.....	150
5.2.7.	Call Settings.....	151
5.2.8.	Make Multi-Party Calls.....	152
5.3.	Audio Modes.....	153
5.4.	In-call Volume.....	154

USING READER CONFIGURATION UTILITY	155
6.1. ReaderConfig Profile Management	156
6.1.1. ReaderConfig Main Menu	157
6.1.2. Profile Menu.....	162
6.2. Configuring Reader.....	166
6.2.1. General Settings	166
6.2.2. Advanced Data Formatting	173
6.2.3. Symbology	187
6.2.4. Profile	189
6.2.5. Reset	194
6.3. Read Printed Barcodes	195
SPECIFICATIONS	197
Platform, Processor & Memory.....	197
Communication & Data Capture	198
Electrical Characteristics	199
Physical Characteristics	200
Environmental Characteristics	201
Programming Support.....	202
APPENDIX I.....	203
Scan Engine Settings	203
Symbologies Supported.....	203
Symbology Settings	206
N6703.....	206
SE4770.....	216
SM4 + SDC	233
APPENDIX II.....	249
Application Menu.....	249
APPENDIX III.....	251
Open Source License	251

INTRODUCTION

The **RS35** mobile computer, powered by Android 10, is light-weight, easy to use, providing powerful and handy tools for the purpose of delivering flexibility in customization.

Specifically designed to work as an industrial PDA, it provides rich options of data collection, voice and data communication, long-lasting working hours, and so on. Its large color transmissive display guarantees ease in reading in all lighting conditions. Integrated with Bluetooth® Class I, v4.0, v4.1, V4.2 v2.1 BLE, v2.1 with BLE V2.1+EDR (Enhanced Data Rate), IEEE 802.11 a/b/g/n/ac/d/h/I/r/k/v networking technologies, the mobile computer also includes a GSM/UMTS/WCDMA/HSPA/HSPA+/LTE/VOLTE module to gain greater speeds and optimal mobility. In particular, an integrated GPRS/EGPRS receiver is made available for use with third-party location-based applications.

This manual serves to guide you through how to install, configure, and operate the mobile computer. The [Care & Maintenance](#) section is specifically crucial for those who are in charge of taking care of the mobile computer.

We recommend you to keep one copy of the manual at hand for quick reference or maintenance purposes. To avoid any improper disposal or operation, please read the manual thoroughly before use.

FEATURES

- ▶ Built tough to survive drop test and sealed against moisture/dust to industrial standard IP65/ IP67.
- ▶ Android 10 operating system with a powerful Qualcomm SDM450 Octa-core 1.8GHz CPU
- ▶ 32GB eMMC flash memory to store OS and software programs
- ▶ 3GB LPDDR3 RAM to store and run programs, as well as store program data
- ▶ One expansion slot for microSDHC card up to 32GB and microSDXC card up to 64GB-2TB.
- ▶ Built-in autofocus 13 megapixels rear camera with LED flash.
- ▶ Left and right side triggers for ambidextrous scanning
- ▶ Total wireless solution – connectivity includes Bluetooth® Class I, v4.0, v4.1, V4.2 v2.1 BLE, v2.1 with BLE V2.1+EDR (Enhanced Data Rate), IEEE 802.11 a/b/g/n/ac/d/h/I/r/k/v networking technologies, GPRS/EGPRS/GSM/UMTS/WCDMA/HSPA/HSPA+/LTE/VOLTE, and near field communication (NFC)
- ▶ A 5.5-inch, transmissive IPS LCD, Corning® Gorilla® Glass 3 display with 720x1400 pixels to deliver excellent visibility in all lighting conditions
- ▶ Configurable feedback indicators including speaker and vibrator
- ▶ Built-in scan engine setting tool Reader Configuration which serves out-of-the-box keyboard wedge functionality

INSIDE THE PACKAGE

The following items are included in the kit package. Save the box and packaging material for future use in case you need to store or ship the mobile computer.

- ▶ RS35 Mobile Computer
- ▶ Snap-on Cable (optional)
- ▶ AC Power Adaptor (optional)
- ▶ Quick Start Guide

ACCESSORIES

- ▶ 1-slot Charging + Communication Cradle
- ▶ Pistol Grip
- ▶ Protective Rubber Boot
- ▶ Hand Strap
- ▶ Pistol Grip
- ▶ UHF RFID Reader

RELATED DOCUMENTATION

Log in to **GoBetween** to access related documentation about the RS35 mobile computer from the CipherLab Central Service (CCS) platform. Download the **GoBetween desktop** or mobile device application, or launch the GoBetween Lite web application from the following site: <http://ccs.cipherlab.com/>.

Chapter 1

QUICK START

This chapter helps you get ready for starting using the mobile computer.

IN THIS CHAPTER

1.1 Overview	24
1.2 Charging & Communication	33

1.1. OVERVIEW

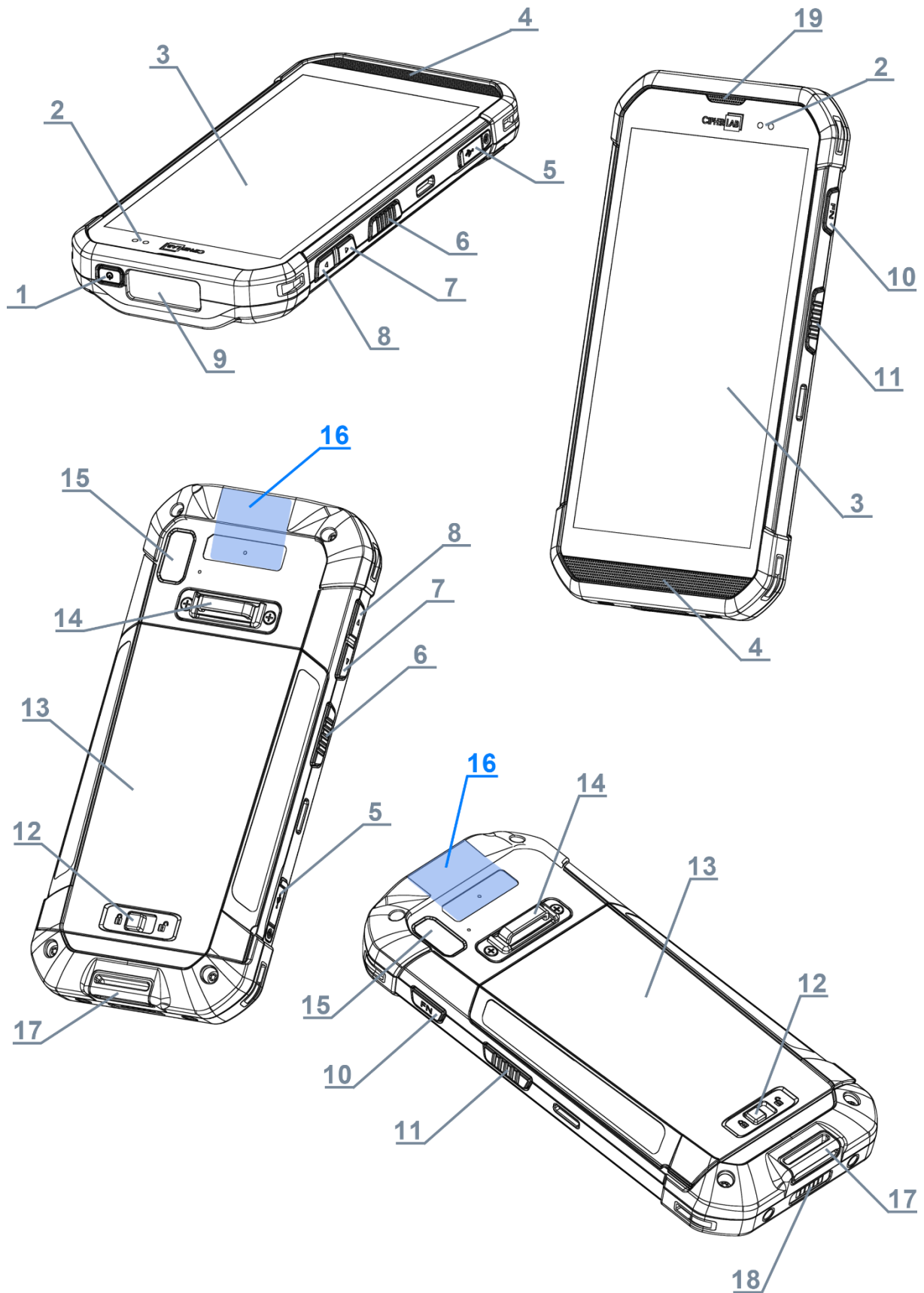

No.	Description	No.	Description
1	Power Button	2	Status LED
3	Touchscreen	4	Microphone & Speaker
5	USB-C Port with Cover	6	Side-Trigger (Left)
7	Volume Down Button	8	Volume Up Button
9	Scan Window	10	Function Key
11	Side-Trigger (Right)	12	Battery Cover Latch
13	Battery with Cover	14	Hand Strap Hole Cover
15	Camera	16	NFC Detection Area
17	Hand Strap Hole	18	Charging & Communication Pins
19	Receiver		

1.1.1. INSTALL/ REMOVE BATTERY

For shipping and storage purposes, the mobile computer and the main battery are saved in separate packages.

Note:

- (1) Any improper handling may reduce the battery life.**
- (2) Always use a fully-charged main battery for battery replacement.**

To install the main battery:

- 1) Insert a fully-charged main battery into the grooves from the battery top, and then press down the lower edge of the battery.

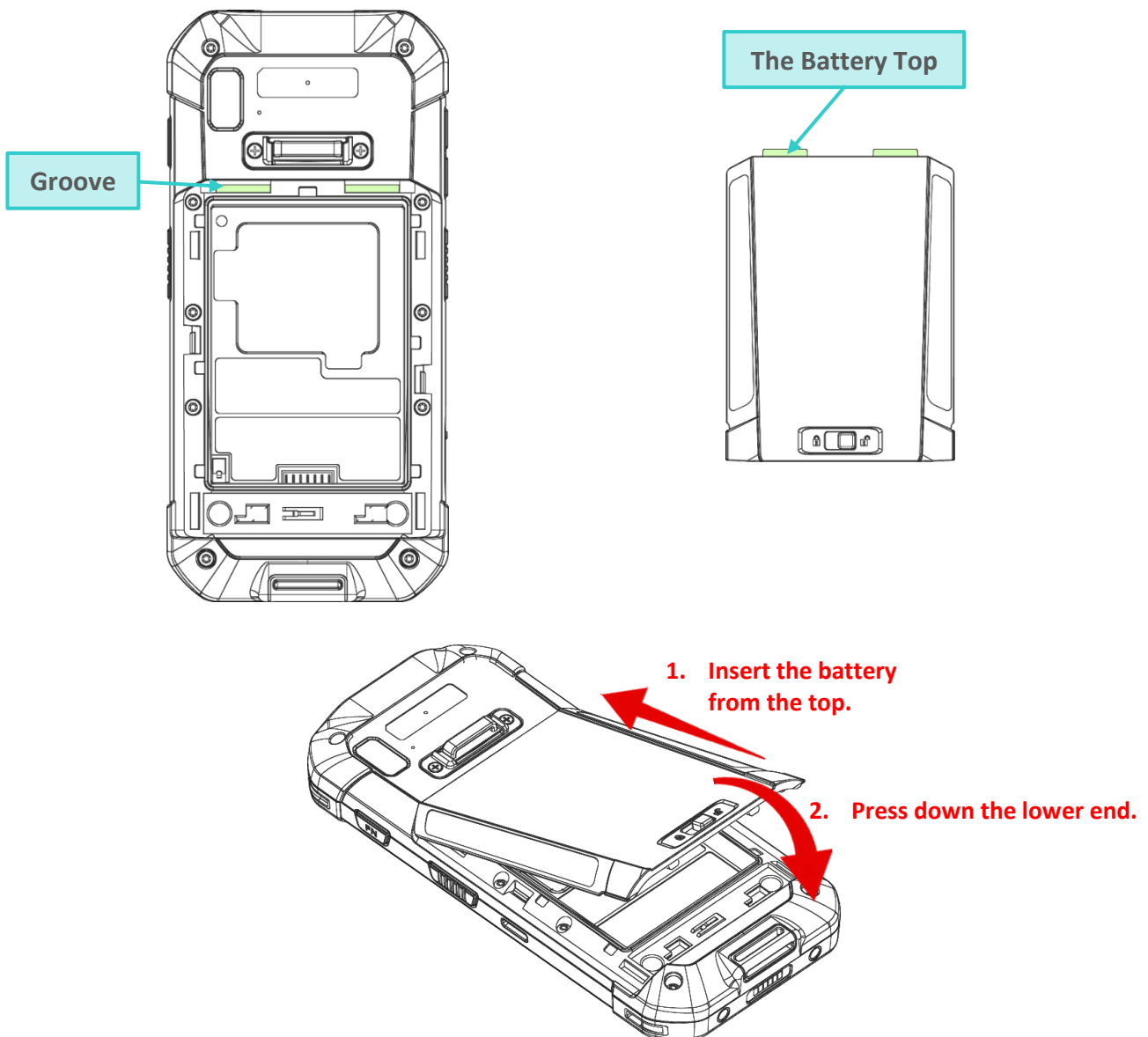

- 2) Press both left and right side edges of the battery to make sure that it is firmly installed without any interstice.

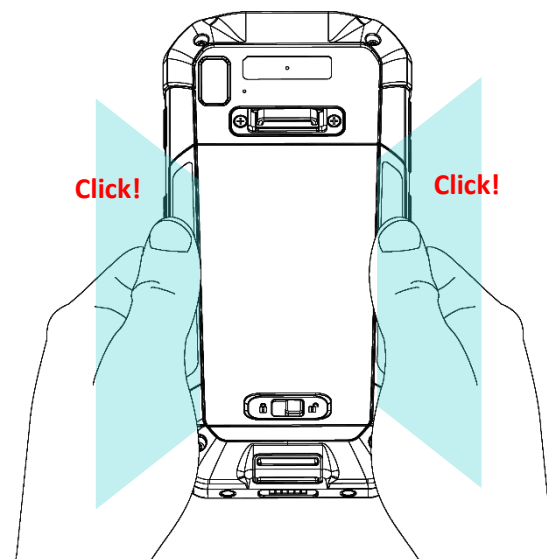

- 3) Slide the battery latch leftward to "Lock" position.



Warning:

- (1) Make sure the battery latch is at the "Lock" position before powering on the device.
- (2) For initial use, insert a charged battery, lock the battery cover in place, and then press the Power key to power on the mobile computer.

REMOVE BATTERY

To remove the battery:

- 1) Slide the battery latch rightward to unlock it.

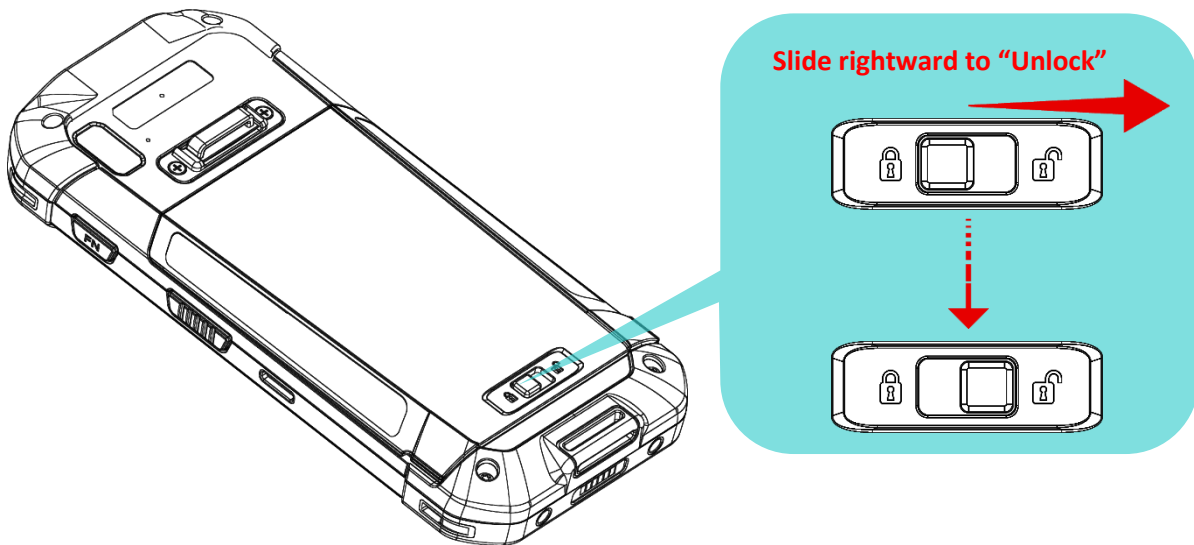

- 2) Once the battery cover is unlocked, it slightly tilts up and is ready to be removed.

By holding the two sides of the battery cover, lift up the main battery (which is with the battery cover) from its lower end to remove it.

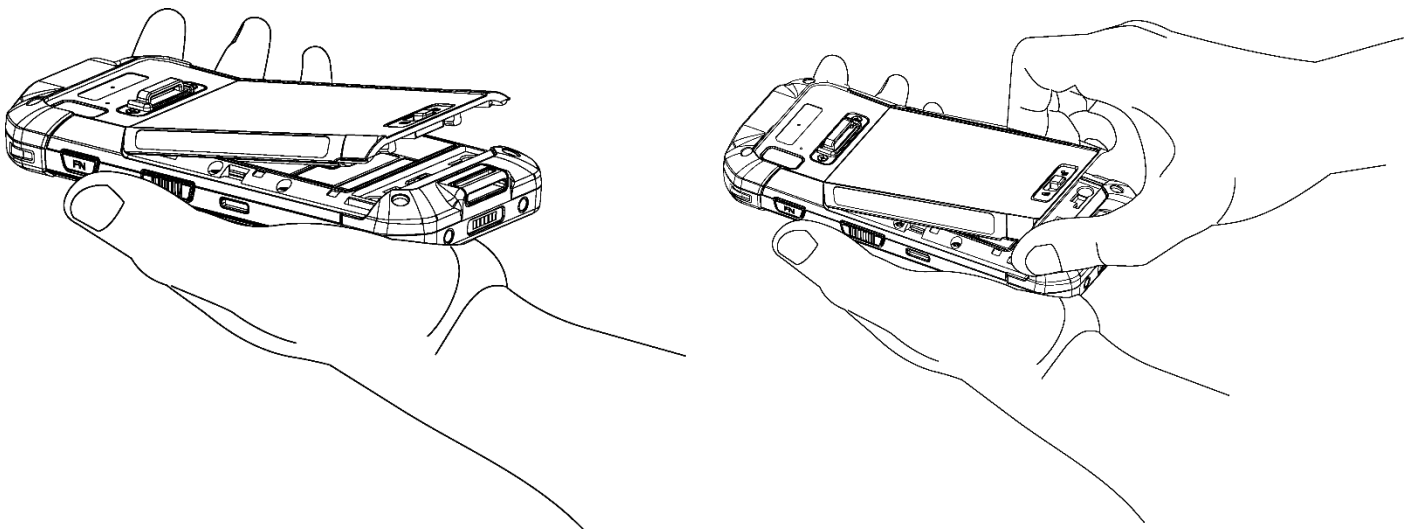

1.1.2. INSTALLING SIM CARD, SAM CARD AND MEMORY CARD

The RS35 mobile computer is equipped with 2 SIM card slots (optional), 1 SAM slot, and 1 memory card slot.

To insert the cards:

- 1) Remove the battery as described in [Remove Battery](#)
- 2) Lift up the inner lid that protects the card sockets chamber by holding the pull tab.

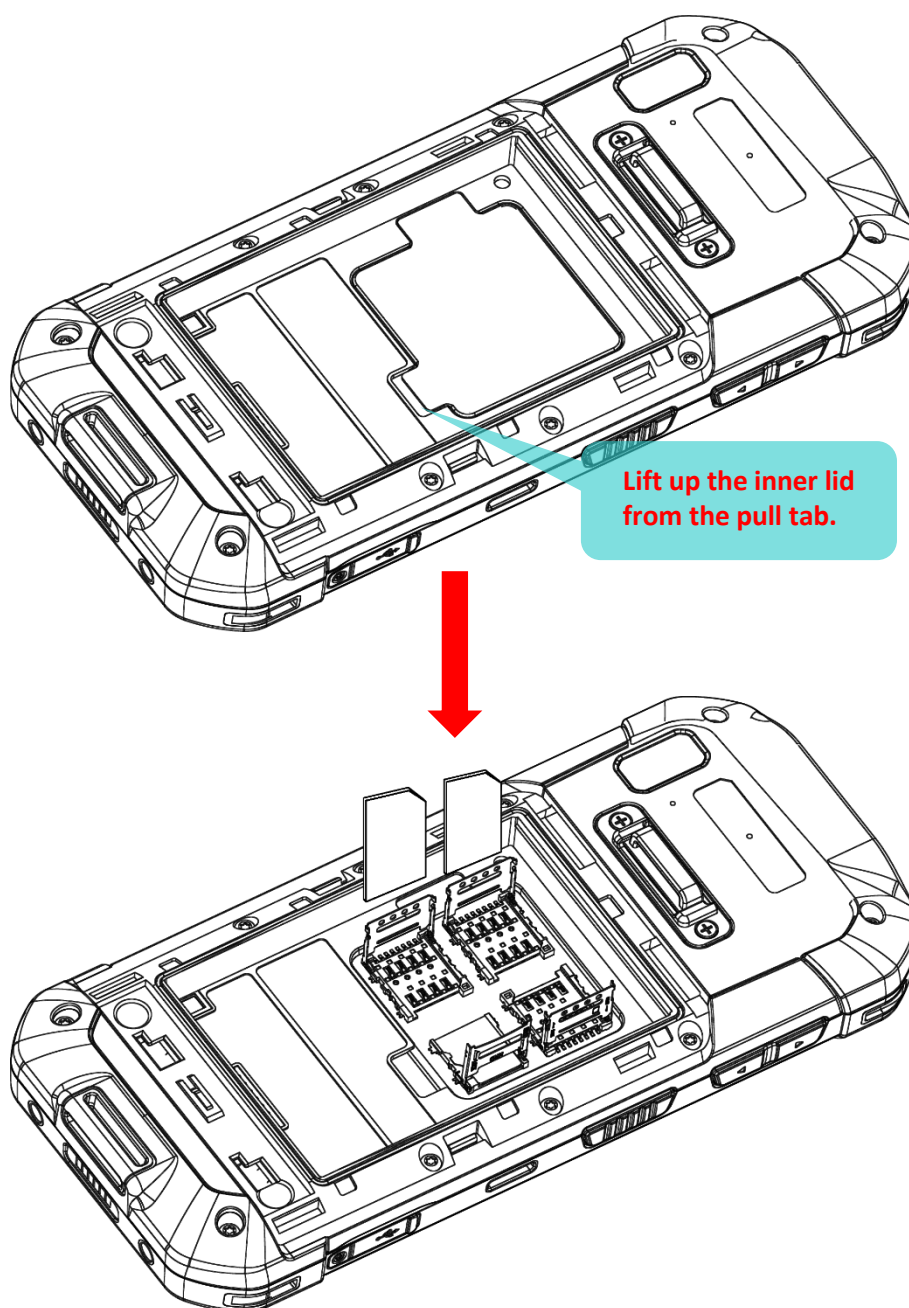

- 3) After the chamber is revealed, insert SIM cards, the SAM card and the microSD card into their respective sockets. Close and push back the hinged cover till a click sounds.

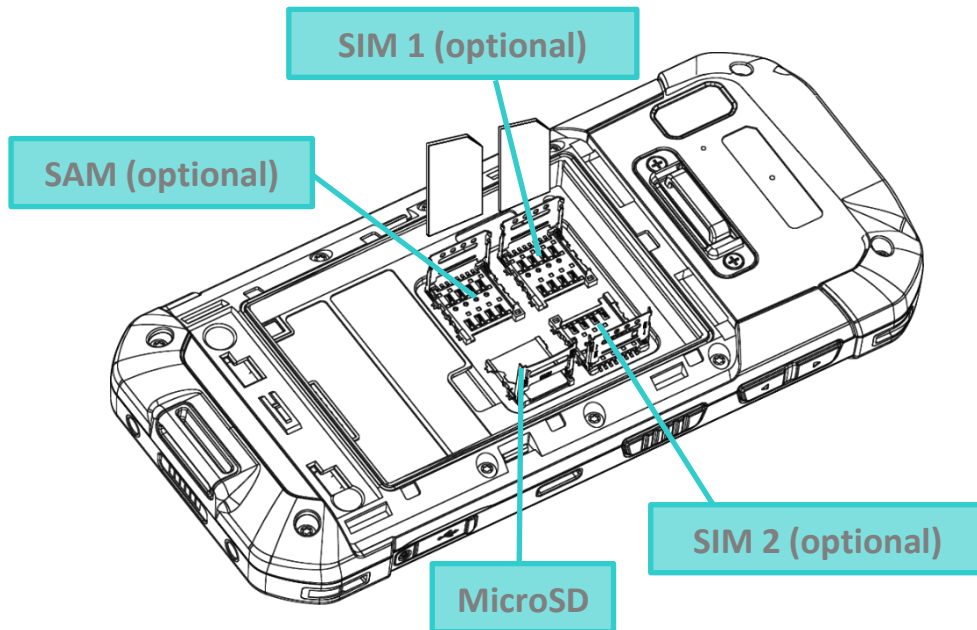

To Install the Cards:

- 1) Slide the hinged cover back.
- 2) Swing the top to open.

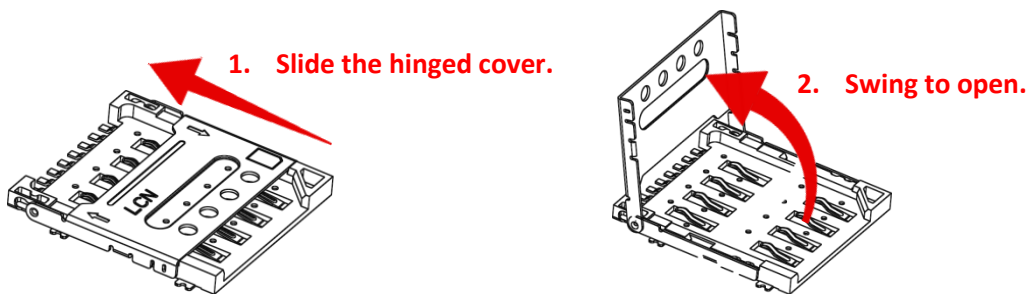

- 3) Insert the cards, close the hinged cover, and then push it back.

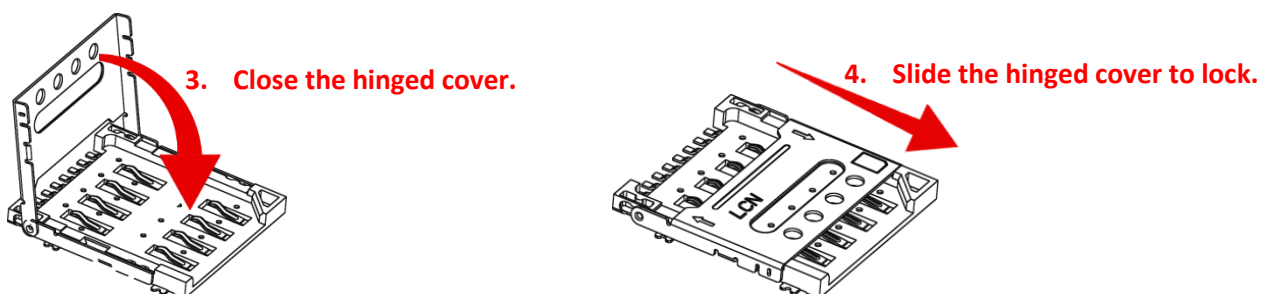

- 4) Place the inner lid back, install the battery cover, and push the battery latch back to the "Lock" position.

REMOVE CARDS

To remove the cards:

- 1) Remove the battery.
- 2) Lift up the inner lid.
- 3) Unlock the card hinge cover and remove the card.
- 4) Mount the inner lid and the battery cover, and slide the battery latch back to the **“Lock”** position

Note:

Both SIM1 and SIM2 card slots support 2G/3G/4G cards. However, you can have 3G/4G data transmission on either SIM but not on both at the same time.

1.1.3. POWER ON/OFF MOBILE COMPUTER

POWER ON

To power on the mobile computer, press and hold the power button  located on the top end of the device. The mobile computer will turn on and show the **Home Screen** after splash screen.

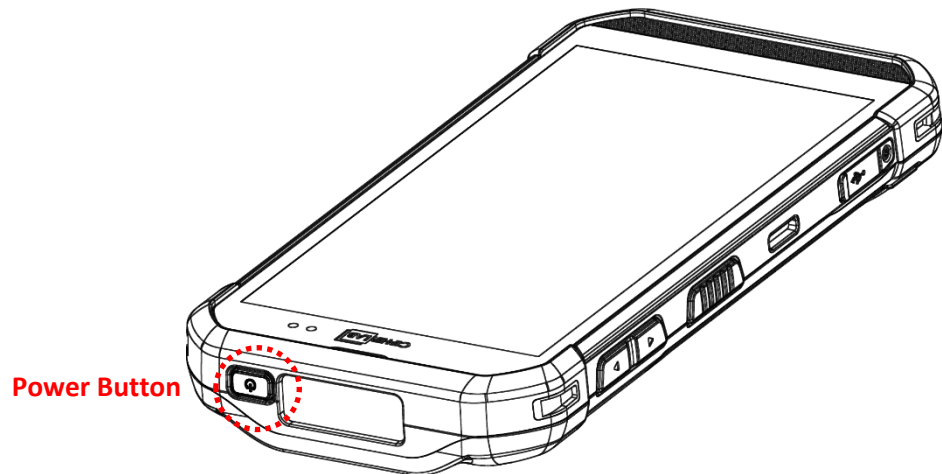

Note:

For the mobile computer to power on, the battery cover must be secured in place.

POWER OFF

To power off the mobile computer, press and hold the power button  for more than three seconds. A menu will appear on-screen which allows you to power off the device. Make sure all user data and tasks have been stored before tapping on **Power off**.

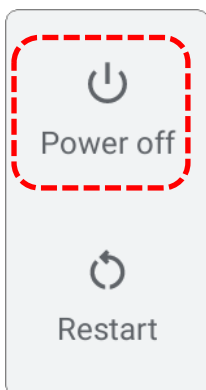

1.2. CHARGING & COMMUNICATION

1.2.1. CHARGE MOBILE COMPUTER

The main battery may not be charged to full for shipment. When you first receive the kit package, you will need to charge the main battery to full before using the mobile computer. You may use the Snap-on Charging Cable or Charging & Communication Cradle along with a power adapter to charge the mobile computer.

Your device can also be charged by connecting to a host computer using a USB Type-C cable. It's slower than charging using the supplied snap-on cable or Charging & Communication Cradle.

CHARGING TIME

▶ **Main battery:**

The main battery powers the mobile computer to work. It takes approximately 4 hours to charge an empty main battery to full. For the first time charging the main battery, please charge it for at least 8 to 12 hours. The charging LED above the screen (located on the right) will light up in red while charging and will turn green when charging is complete.

Backup battery:

The backup battery is mounted on the main board. Its role is to temporarily keep the mobile computer in suspension when the main battery is drained out so data in DRAM will be retained. The backup battery can be charged by the main battery or the power adapter, and takes approximately 4 hours to charge to full under the condition that it is always be charged except of power off.

▶ **RTC Battery:**

RTC battery is a rechargeable SMT type Li-battery. RTC retention will be maintained for at least 72 hours when the main battery is removed.

CHARGING TEMPERATURE

The allowed battery charging ambient temperature is between 0°C to 40°C. It is recommended to charge the battery at room temperature (18°C to 25°C) for optimal performance.

Please note that battery charging stops when ambient temperature drops below 0°C or exceeds 40°C.

OPERATION ON BATTERY POWER

When Bluetooth® Class I, v4.0, v4.1, V4.2 v2.1 BLE, v2.1 with BLE V2.1+EDR (Enhanced Data Rate), IEEE 802.11 a/b/g/n/ac/d/h/I/r/k/v networking technologies, GSM/UMTS/WCDMA/HSPA/HSPA+/LTE/VOLTE, and GPRS/EGPRS are all enabled on battery power, the main battery level will drop down substantially. Prolonged use of the display and continued scanning of barcodes will also affect battery level.

In order to prevent system from shutting down after the battery is drained out, we suggest that you keep a fresh battery for replacement at all times, or connect the mobile computer to an external power.

BATTERY STATUS & STATUS LED DURING CHARGE

When RS35 mobile computer is connected with the external power source, the Status LED located above the touch screen shows as below:

LED Status	Description
Red, solid	Charging the mobile computer
Red, blink	Charging error
Green, solid	Charging complete
No light	The cable is not correctly connected

USE SNAP-ON CABLE

The Snap-on Cable provides a convenient way to charge your mobile computer as well as data communication.

To install:

- 1) Remove the USB Type-C cable if it is connected with the RS35 mobile computer.

- 2) Hold the snap-on cup toward the bottom of the RS35 mobile computer, and place one of the snap-on cup side to the side of the RS35 mobile computer.

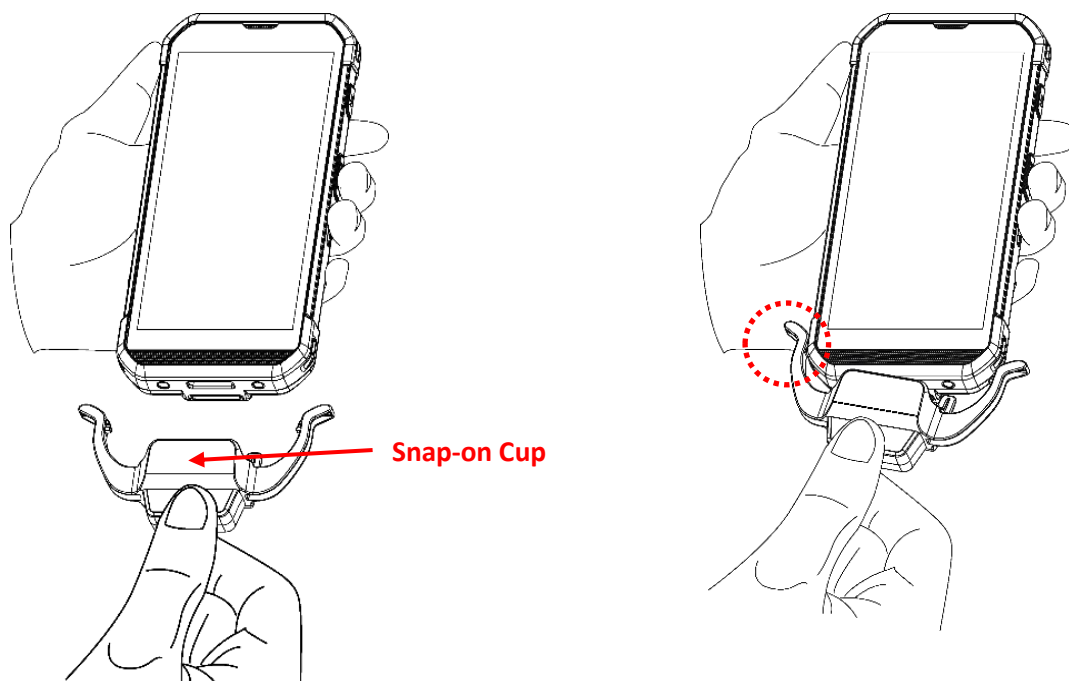

- 3) Push the Snap-on cup upwards to make its another side to be attached to the RS35 mobile computer.
- 4) A "click" sound is made once the Snap-on cable is connected with the bottom of the RS35 mobile computer in place.

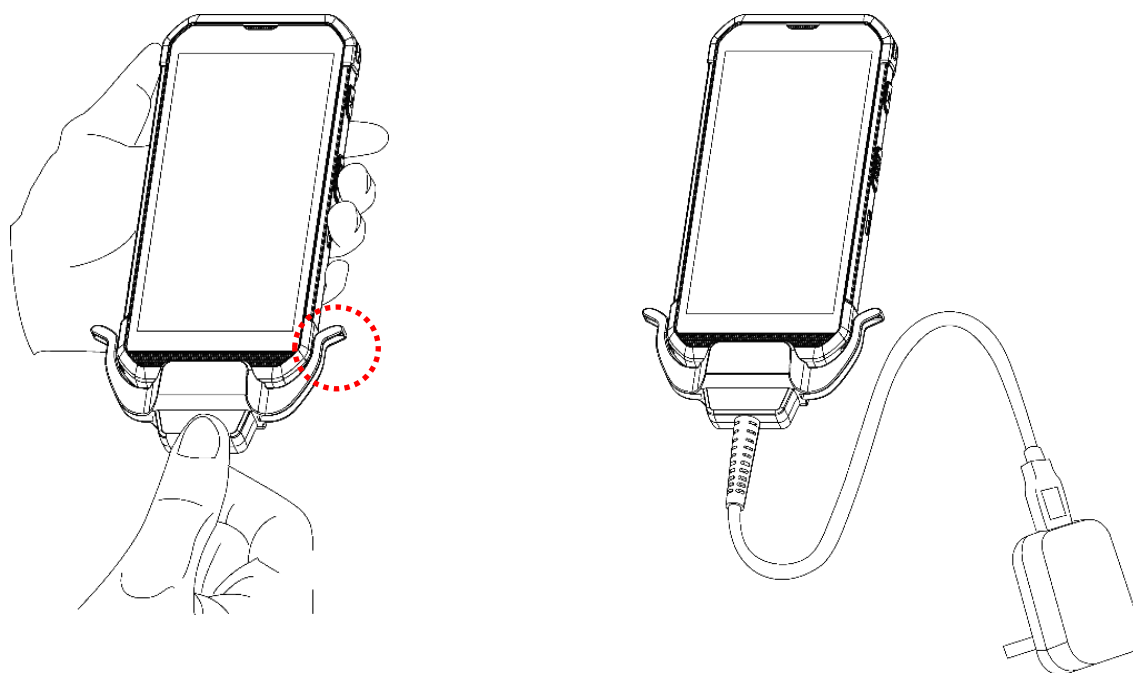

- 5) Connect the USB plug to the approved adapter for external power connection, or plug it to the USB port of PC/laptop for data transmission/ charging.

While the device battery is being charged, the LED on mobile computer will indicate charging status.

LED Indicator	Status	Description
Charging	Red, solid	Charging the mobile computer
	Red, blink	Charging error
	Green, solid	Charging complete
	No light	The cable is not correctly connected

Note:

- (1) The USB Type-C cable must be removed before installing the snap-on cable.
 - (2) For data communication, you could also use a USB Type-C cable to connect the mobile computer to your PC or laptop.
-

USE CHARGING & COMMUNICATION CRADLE

The Charging & Communication Cradle charges your mobile computer and a spare battery at the same time, and it could also be used for data communication.

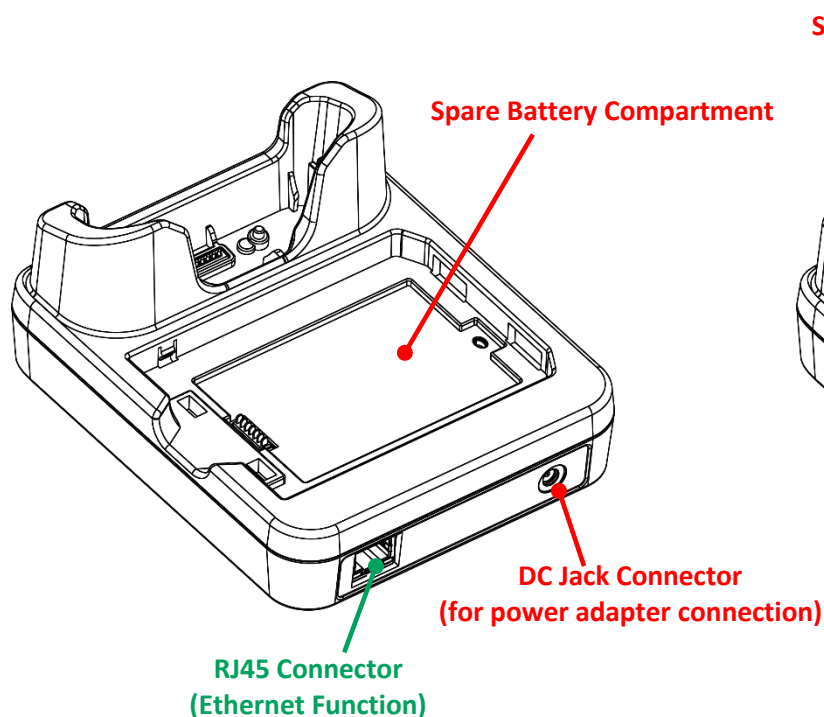
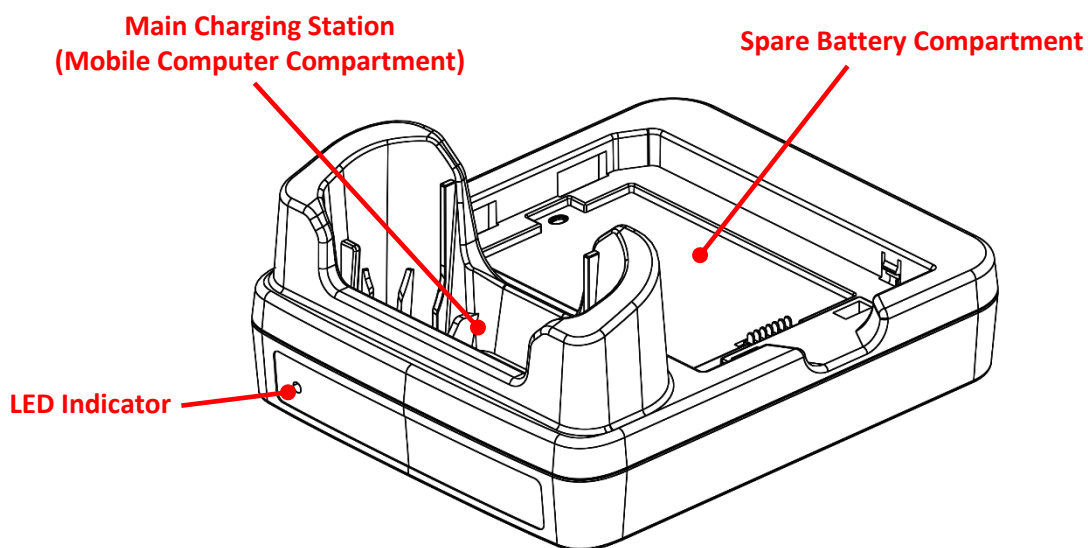

ENCR Model

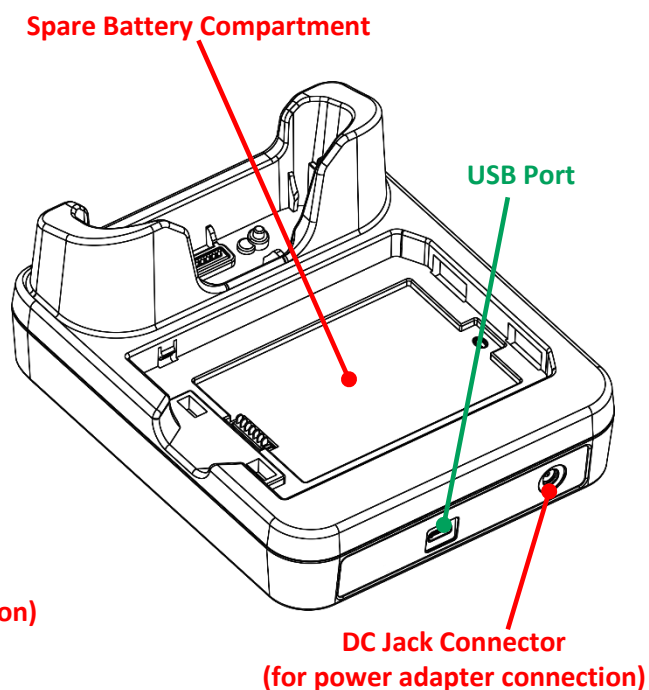

CCCR Model

Note: The Charging & Communication Cradle is equipped with either one USB Port (CCCR Model) or one RJ45 Connector (ENCR Model).

To charge your mobile computer on the Charging & Communication Cradle:

- 1) Remove the USB Type-C cable if it is connected with the RS35 mobile computer.
- 2) Insert the RS35 mobile computer onto the Cradle. The installed hard shell or hand strap is not necessary to be removed in advance before inserting the mobile computer. To remove, please take out the RS35 mobile computer directly.

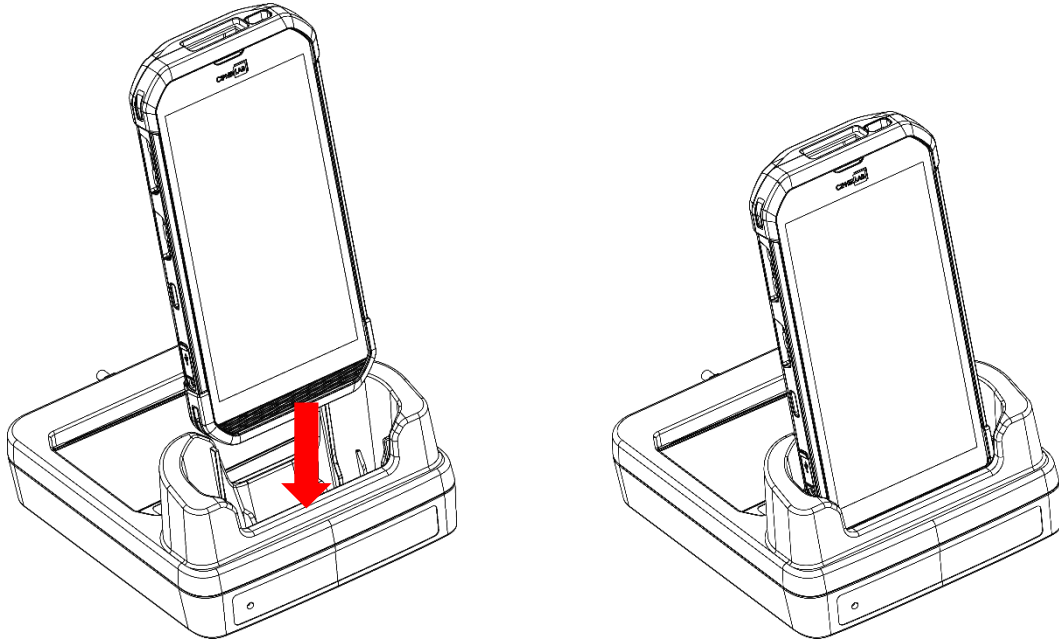

- 3) For the spare battery, please insert the battery from its top side into the spare battery compartment of the cradle, and then press down the bottom side of the battery (where the battery latch is located).

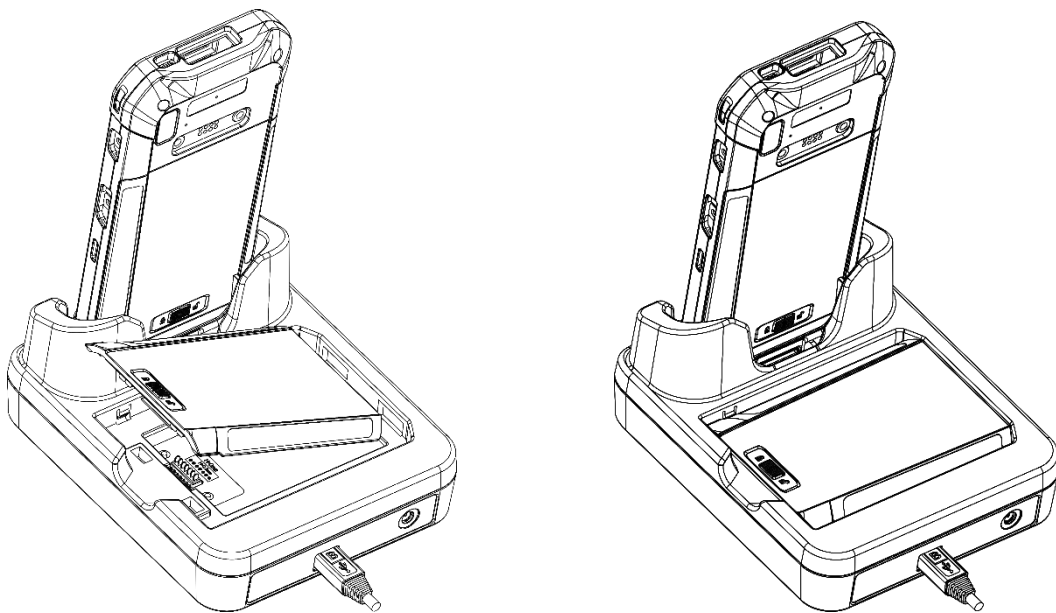

To remove, directly take the battery out.

4) Connect the adapter to the Cradle, and plug the other end into an electrical outlet.

The status of the mobile computer charging is shown on the device itself, while the LED indicator on RS35 Charging & Communication Cradle shows the status of battery charging as below:

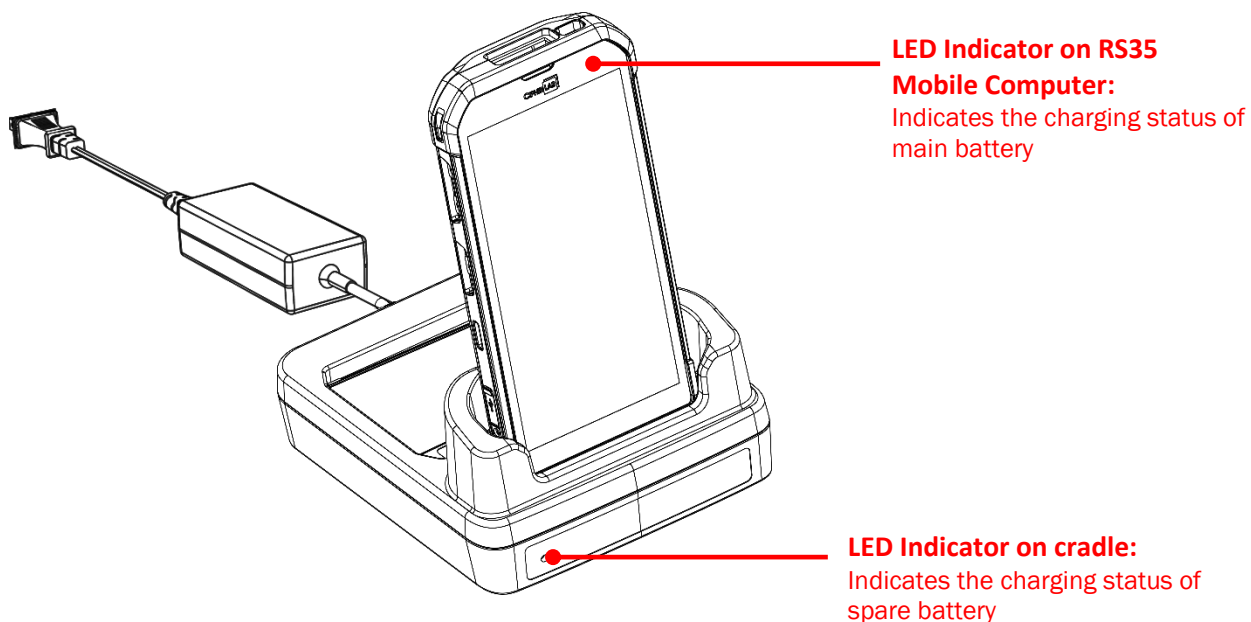

Cradle LED Indicator	Status	Description
Charging	Red, solid	Charging the battery
	Red, blink	Charging error
	Red, flash once	No battery
	Green, solid	Charging complete
	No light	Not charging

Note:

- (1) **Not Charging** could be the result of battery damage, battery's failure to touch the connector, or AC plug coming off.
- (2) Charging error could be due to high battery temperature.
- (3) The USB Type-C cable must be removed before inserting the device onto the cradle.

1.2.2. WIRED DATA TRANSMISSION

Use a USB Type-C cable or the snap-on Cable or the cradle to connect the mobile computer to your PC for data transmission.

- 1) Connect your device to the computer with a USB Type-C cable/ Snap-on Cable / Cradle.

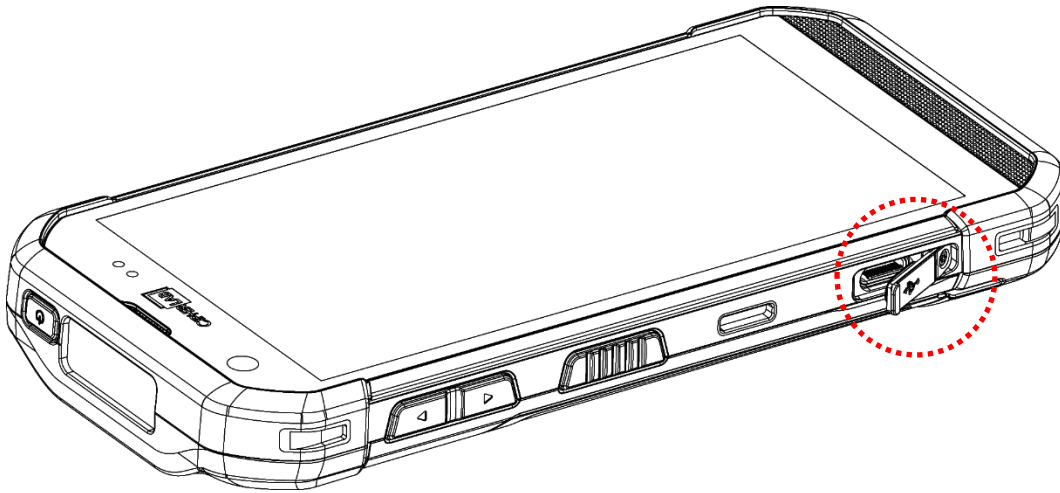

- 2) Once connected, "USB Preferences" page shows up. By default, the device will be in charging mode with the status "No data transfer", in which you are unable to access the files on this device from the PC client.

- ▶ To transfer all types of files between your device and PC, choose "File Transfer".
- ▶ To transfer videos and photos, you can select "PTP", in which your device will share only videos and photos in DCIM and Pictures folders.

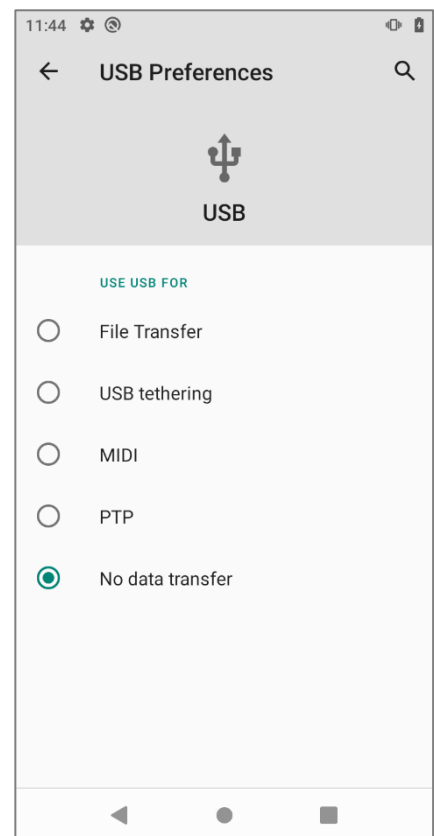

To change the USB usage after you leave **“USB Preferences”** page, please swipe down from the status bar to reveal [Notifications Drawer](#), and then tap on the system notification **“USB file transfer turned on”** or other USB usage notification just like this (depending on what you chose last time) to enter **“USB Preferences”** to select the option you’d like to use USB for.

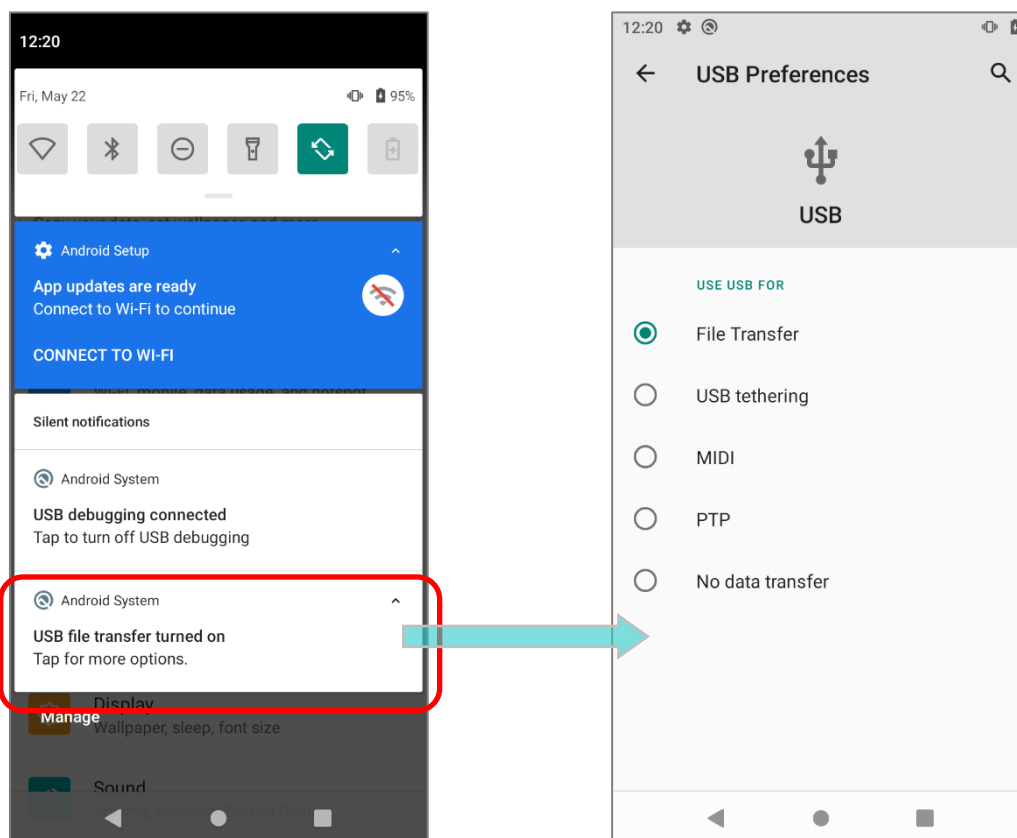

1.2.3. USING WIRELESS NETWORKS

The mobile computer supports widely applied wireless technologies including Bluetooth® Class I, v4.0, v4.1, V4.2 v2.1 BLE, v2.1 with BLE V2.1+EDR (Enhanced Data Rate) is able to send/receive data in real time in an efficient way.

Select GSM/UMTS/WCDMA/HSPA/HSPA+/LTE/VOLTE modules embedded for a total wireless solution for data and voice communication.

Chapter 2

USING RS35 MOBILE COMPUTER

This chapter walks you through the fundamental usage and features of this device.

IN THIS CHAPTER

2.1 Battery	43
2.2 Memory	59
2.3 Touch Screen	71
2.4 Notifications	78
2.5 Date and Time	83
2.6 Language & Keyboard Input	85
2.7 Enterprise Settings	89
2.8 Sound and Volume	90
2.9 Data Capture	91

2.1. BATTERY

▶ **Main Battery**

The mobile computer is powered by a rechargeable 3.85V, 4000mAh Li-Polymer battery pack, and it takes approximately 4 hours to charge it to full from the power adaptor (for the first time charging the main battery, please charge it for at least 8 to 12 hours). However, the charging time may vary by your working condition.

▶ **Spare Battery**

A spare battery pack is provided as an accessory. We recommend keeping a fully charged spare battery at hand in order to replace the main battery when it is nearly drained out.

▶ **Backup Battery**

Settled on the main board is a backup battery that keeps the mobile computer in suspension when the main battery is depleted. The backup battery is a 3.7V, 90mAh rechargeable Li-Polymer battery, and can retain data in the DRAM for 5 minutes when it is fully charged (as long as wireless modules on the mobile computer are inactive).

It also keeps Wi-Fi and Bluetooth connections for about 30 seconds in suspend mode after the main battery is removed. The Wi-Fi and Bluetooth connections will resume right after the main battery is installed within the time period the connection is retained.

The backup battery can be charged by the main battery or the power adaptor, and takes approximately 4 hours to charge to full under the condition that it is always be charged except of power off.

▶ **RTC Battery**

RTC battery is a 3V, 1mAh rechargeable SMT type Li-battery which takes about 12 hours to be fully charged. RTC retention will be maintained for at least 72 hours when the main battery is removed.

Warning:

- (1) The battery cover must be secured in position with its latch locked.**
 - (2) For a new battery, make sure it is fully charged before using.**
 - (3) To avoid data loss, when replacing the main battery, make sure you replace it with a well-charged spare battery pack. Always prepare a spare battery at hand, especially when you are on the road.**
 - (4) When the mobile computer has been on backup battery for 5 minutes, the system will shut down. Be sure to replace the main battery as soon as possible in order to avoid data loss.**
 - (5) To avoid system crash, system will NOT resume from the suspend mode if the power of the installed main battery is less than 10%.**
-

2.1.1. BATTERY STATUS INDICATORS

The main battery pack is the only power source for the mobile computer to work. Therefore, when the main battery level goes low, you need to replace the battery pack with a charged one or charge it as soon as possible. Most of all, you should backup important data on a regular basis.

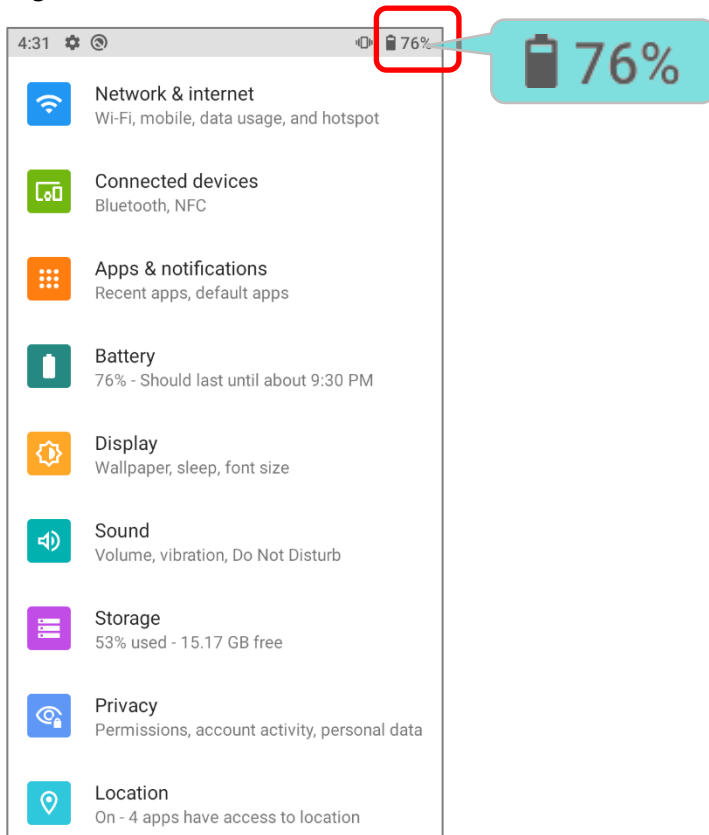

By checking the battery status icon on **Status Bar**, you can tell the battery level remaining in the main battery.



Battery Icon	Description
	Main battery is fully charged.
	Main battery level is partially drained.
	Main battery level is low (5%~15%).
	Main battery level is very low and needs charging immediately (<5%).
	External power source is connected and main battery is being charged.

The percentage beside the battery icon on the status bar can be switched on or off in [App Drawer \(All Apps\)](#) |

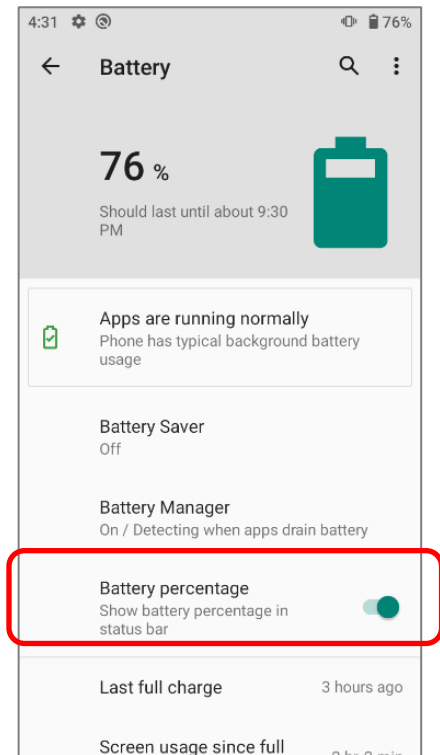
Settings  | **Battery**  | **Battery Percentage**



Note:

When the mobile computer is fully charged and battery level reaches 100%, the battery icon will change from  to  to indicate charging is completed.

Warning:

- (1) Once the battery level drops below 15%, the low battery notification will be displayed on the screen.
- (2) Data loss with RAM may occur when battery level is low. Always save data before the battery runs out of power or keep a fresh battery for replacement.
- (3) Constant usage of the mobile computer at low battery level can affect battery life. For maximum performance, recharge the battery periodically to avoid battery drain out and maintain good battery health.

2.1.2. MONITOR BATTERY LEVEL

MAIN BATTERY LEVEL

The main battery is the only source that feeds the mobile computer to work. It also supplies the backup battery on the main board in order to retain the data stored in DRAM. When main battery level gets low, recharge it or replace it as soon as possible. Most critically, back up the important data from time to time to protect your work.

To check main battery level, please go to [App Drawer](#) | **Settings**  | **Battery** 

Battery level percentage is shown to provide a clear grasp of the remaining battery power.

Tap the “**More**” button  on action bar and then tap on “**Battery usage**” to enter “**Battery usage**” page, the screen shows the rate of battery discharge since the last battery charging session, how long the device has been running on battery power, and which applications are consuming the most battery power.

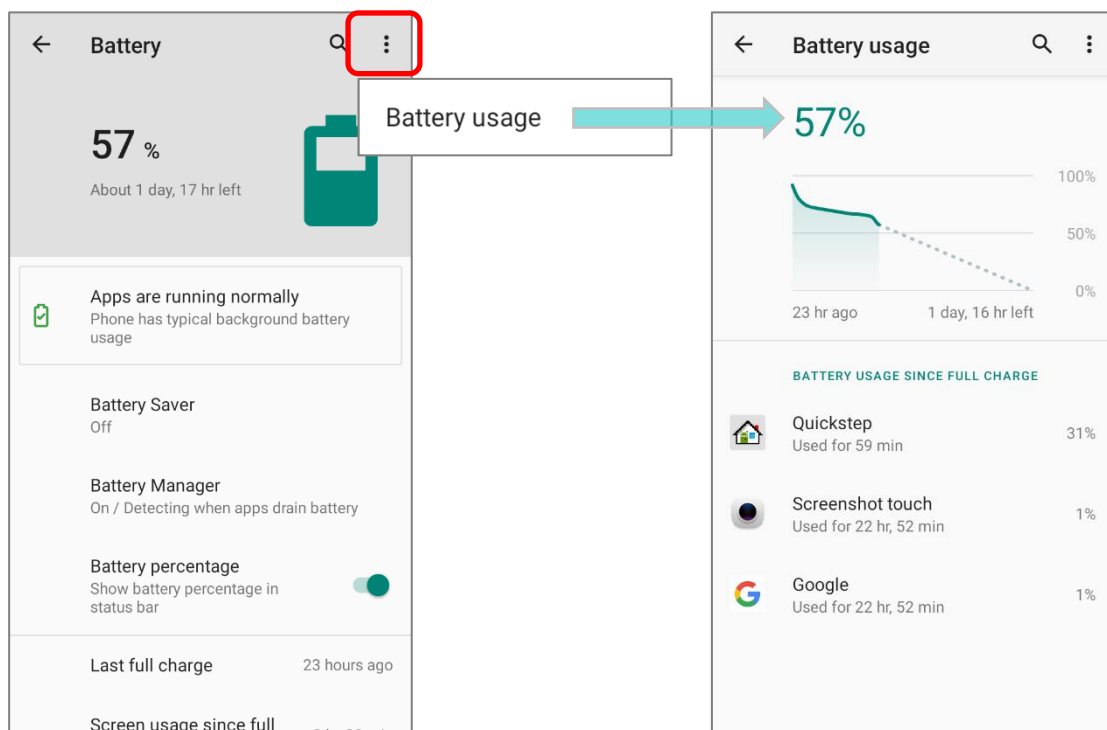

The screen also shows the rate of battery discharge since the last battery charging session, how long the device has been running on battery power, and which applications are consuming the most battery power.

BATTERY SAVER MODE

You can have the **Battery saver mode** automatically turned on when the main battery gets low. This mode will limit the use of location services, vibration and most background processing data.

- 1) On Battery screen, tap "**Battery saver**" to enter "**Battery saver**" page, and then tap on "**Set a schedule**".

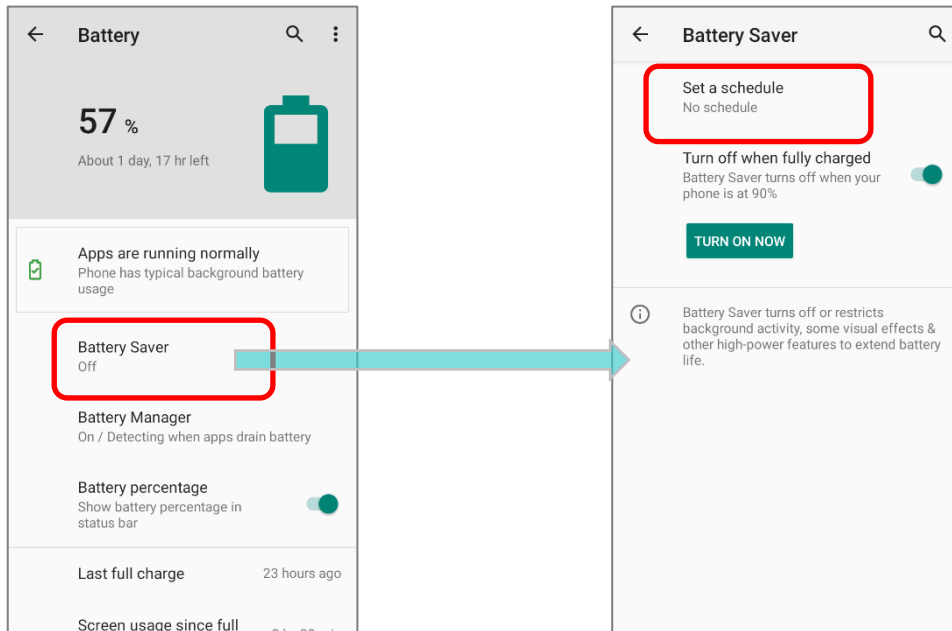

- 2) Tap the radio button of "**Based on percentage**" to display the slider which can be dragged to set when to enable the battery saver mode according to the battery power percentage. The default setting is 5%.

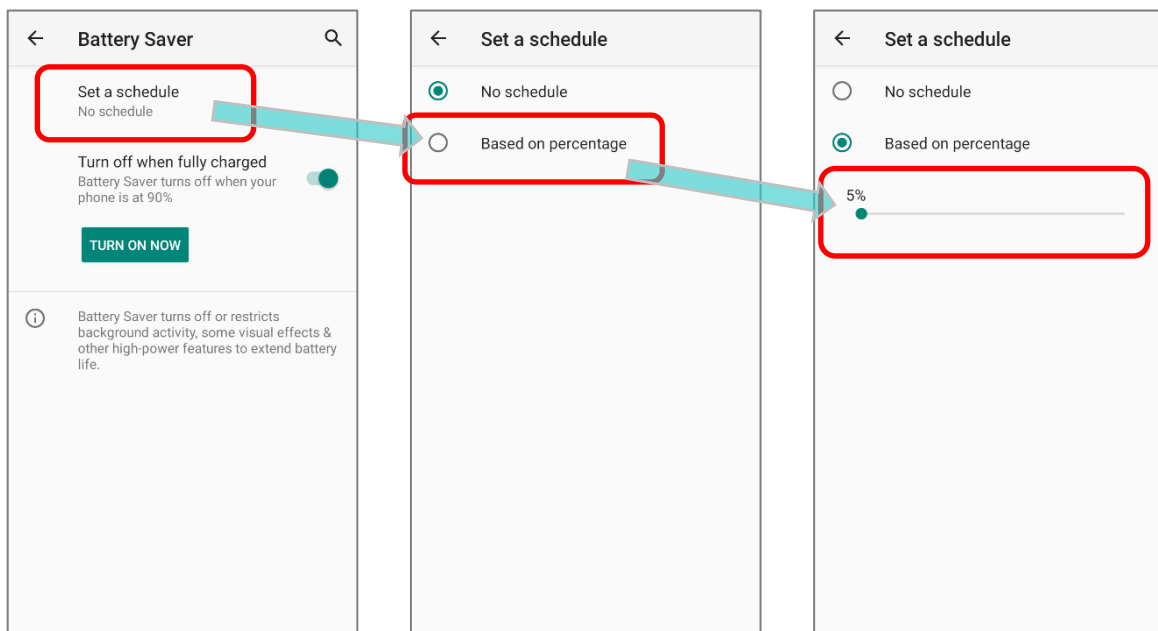

By enabling **“Turn off when fully charged”** on **“Battery Saver”** page, the battery saver mode will be automatically off once the battery power is charged to be 90%. Tap on **“TURN ON NOW”** to directly enable battery saver function, and the battery icon on status bar will turn orange once this function is enabled.

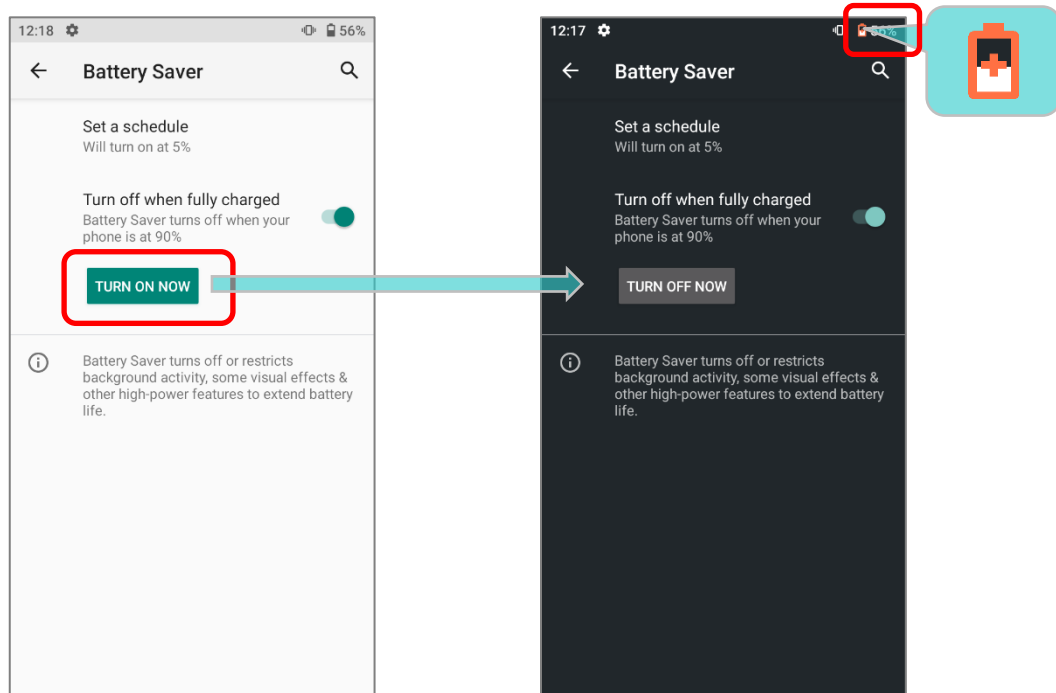

Also, you can swipe down from the status bar to reveal **Quick Settings Panel** or **Quick Settings Menu**, and tap the battery saver icon to enable/ disable it.

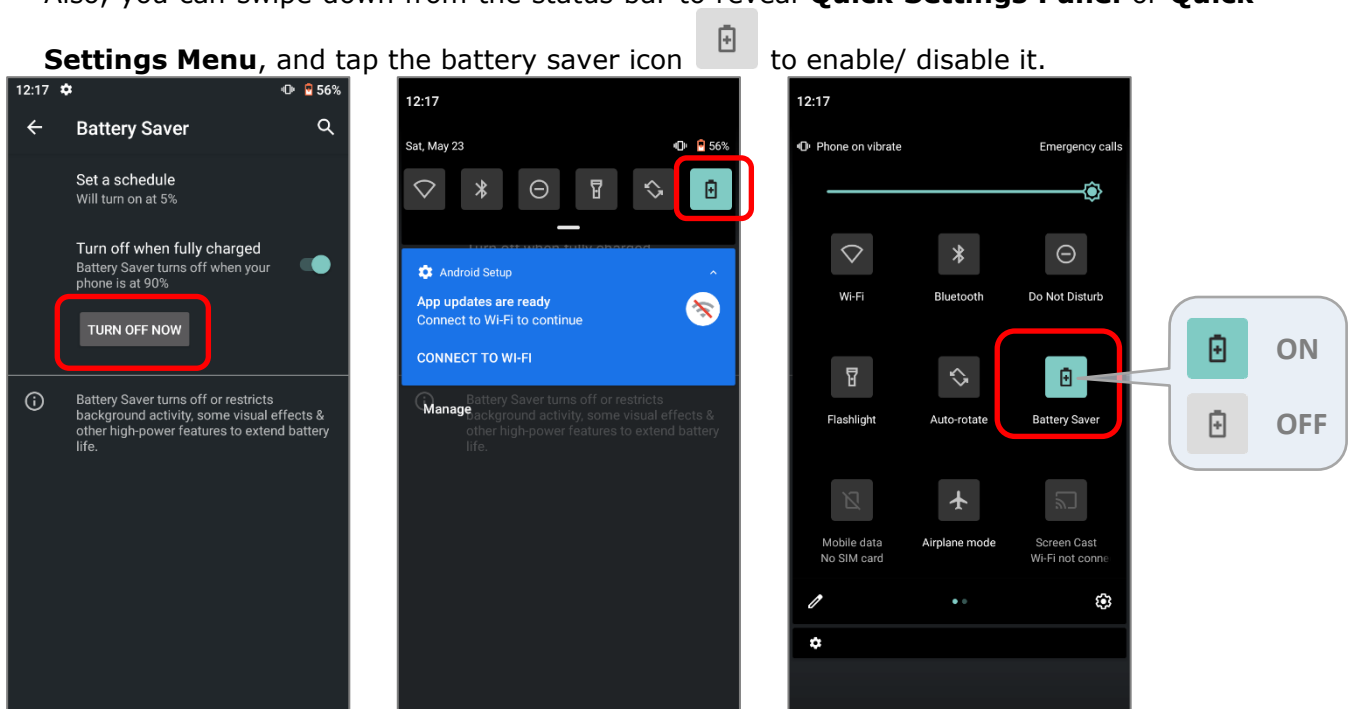

Note: This mode will automatically become inactive when your device is being charged.

BATTERY OPTIMIZATION

With **Battery optimization enabled** for the applications, you can make sure they stay inactive when your device is idle or when they have not been used for days.

- 1) On **Battery** screen, tap on **More**  and select **"Battery usage"**.
- 2) Tap on any item under **"BATTERY USAGE SINCE FULL CHARGE"** to enter its detail page.
- 3) tap on **"Battery optimization"**.

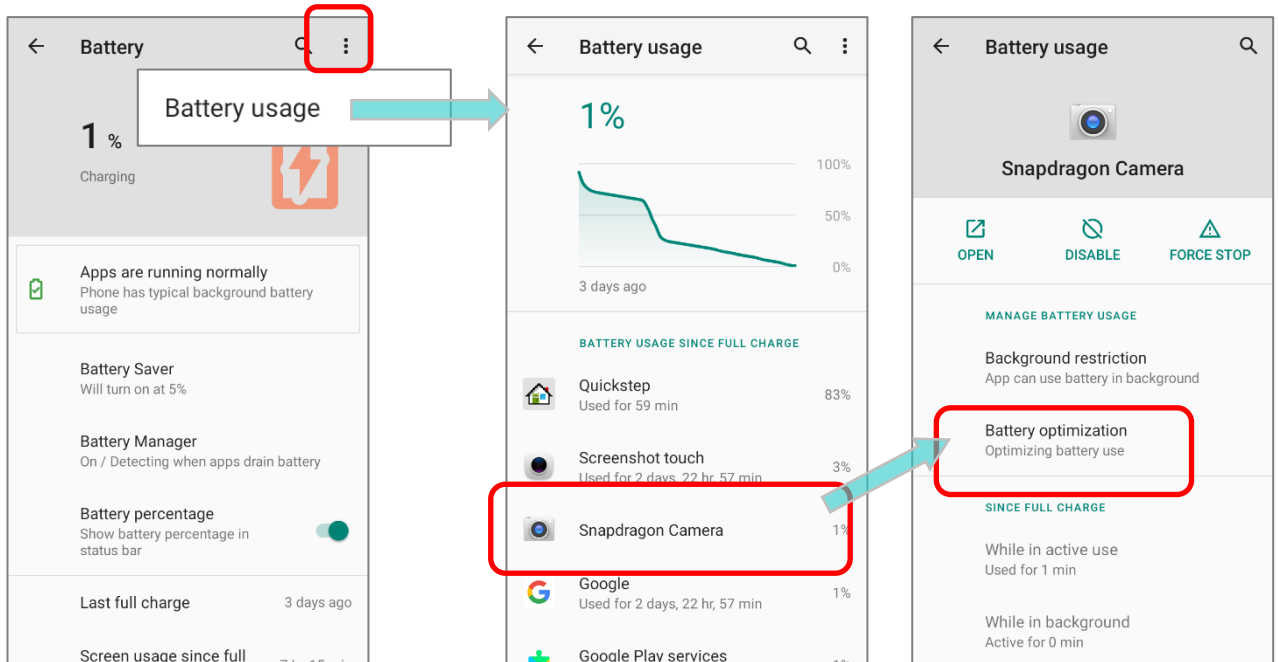

- 4) Tap on **"NOT OPTIMIZED"** to open the dropdown list and select **"All apps"**. All the optimized applications are listed.

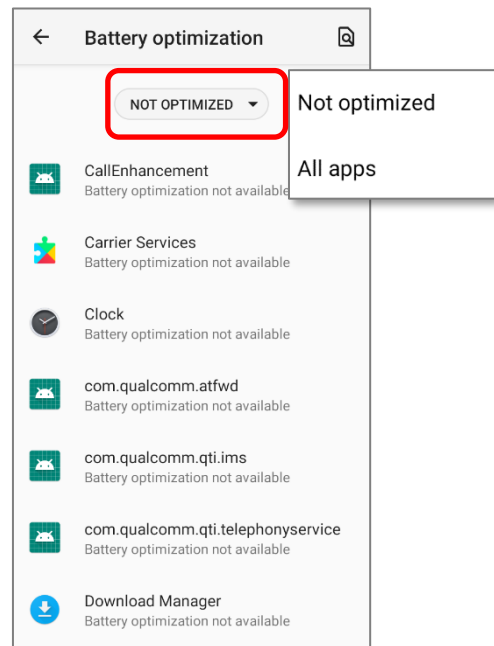

- 5) You can individually turn off the optimization mode of a certain app if you would like it always activated by tapping on the app name and select "**Don't optimize**" and then "**DONE**".

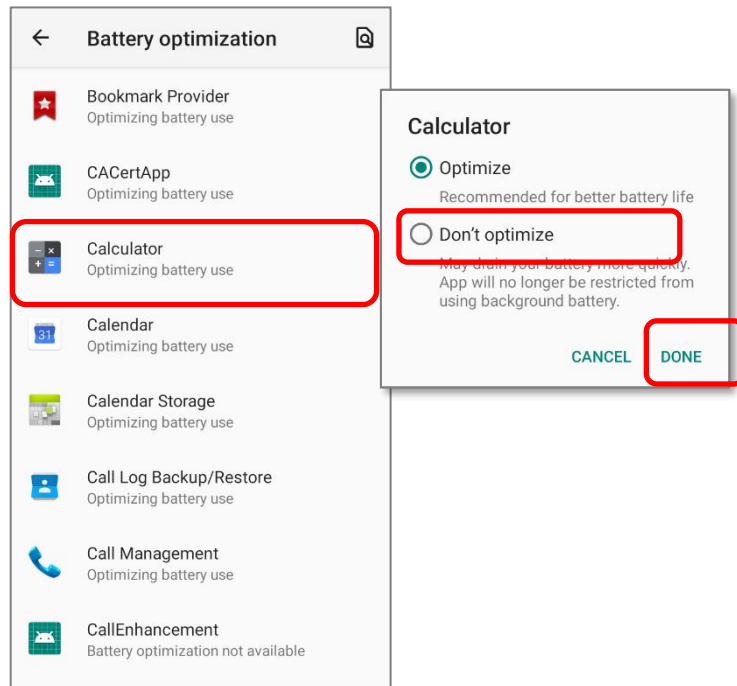

LOW BATTERY ALERT

The mobile computer prompts a warning notification reminding you to charge the main battery when the main battery level drops to **15%** and **5%**.

Opening [Notifications Drawer](#), you will also see this warning appearing on the notifications list; you may turn on [Battery Saver Mode](#), connect the mobile computer to an external power source, or replace the main battery pack as soon as possible. To replace the main battery pack, see [Replace Main Battery](#).

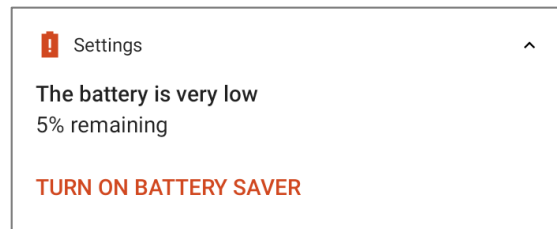
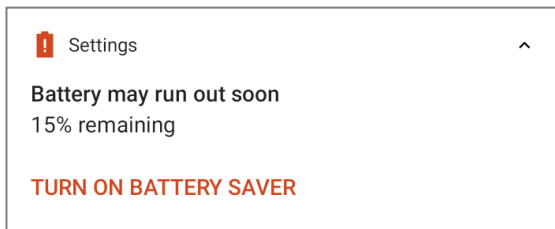

LOW SUB BATTERY ALERT

When the main battery's power is drained out, RS35 mobile computer will automatically suspend by backup battery's power for 5 minutes. When backup battery's power is low, the "**Low Sub Battery**" notification will remind you to connect the device with an external power source to charge it immediately. Please note that do not replace the main battery at this moment, otherwise data loss may occur.

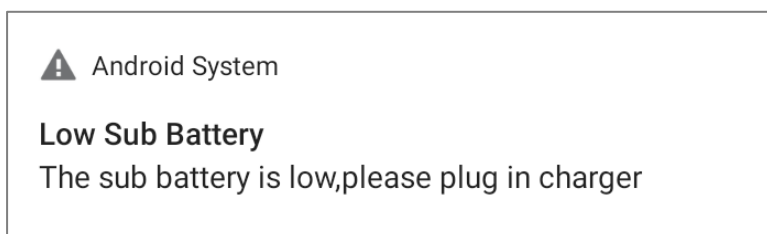

2.1.3. REPLACE MAIN BATTERY

When main battery level is low, follow the steps below to replace the main battery.

Note: Always use a fully-charged main battery for battery replacement.

SHUT DOWN TO REPLACE THE MAIN BATTERY

Shut the device down to replace the main battery, please:

- 1) Make sure the sub battery (backup battery) and the new main battery are fully-charged.
- 2) Press and hold the [power button](#) on the top end of the mobile computer.
- 3) Tap “**Power off**” in the pop-up menu. The mobile computer will power off.
- 4) Follow the steps as [Install/ Remove Battery](#) describes to remove the main battery and replace it with the new one.

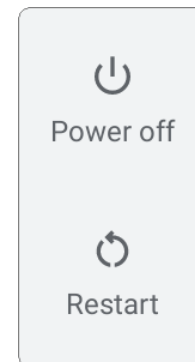

BATTERY SWAP

RS35 backup battery supplies system power during battery swap. When battery cover is removed, the system will enter suspend mode and not wake up until battery cover is put back and the power button is pressed. Please refer to “[Low Sub Battery Alert](#)” section to make sure the sub battery is fully charged before battery swap process.

The available temperature range for main battery hot swap is from 0°C to 50°C. During the period of battery swap, the Wi-Fi and Bluetooth connections are remained for about 30 seconds.

- 1) Directly remove the main battery. The screen is off and the system enters suspend mode.
- 2) When the main battery is removed, system can stay in suspend mode for about 5 minutes. Please replace with a fully-charged main battery as soon as possible.
- 3) Install a fully-charged main battery by following the steps described in [Install/ Remove Battery](#).
- 4) Make sure the main battery is properly installed before pressing the power button to wake up the mobile computer from suspend mode.

Warning:

Please do not perform a battery swapping before the mobile computer's OS is ready. Removing the battery cover during powering up your mobile computer may cause system failure.

Note:

- (1) Make sure to remove the AC or USB Type-C cable before proceeding "Battery Swap".**
- (2) When main battery is removed, the system will stay in suspend mode for about 5 minutes. To prevent the system from being shut down without advance warning, please DO replace the main battery as soon as possible.**
- (3) Backup battery keeps the mobile computer in suspension when the main battery is depleted. Thus, to prevent data loss, DO NOT replace the main battery when backup battery's power is low. Please connect RS35 mobile computer with the external power source to charge it till the "Low Sub Battery" notification icon disappears from the status bar. Once the "Low Sub Battery" notification disappears, the main battery replacement could be proceeded.**

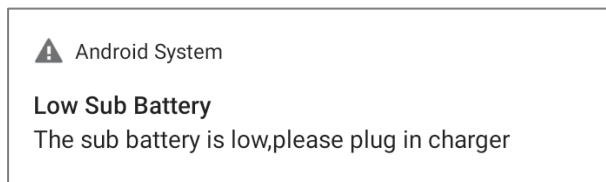

2.1.4. POWER MANAGEMENT

For any portable device, power management is a critical issue especially when you are on the road. Below are some tips to help you save battery power.

Warning:

Using backlight, wireless connectivity, and peripheral devices while on battery power will substantially reduce battery power.

- ▶ Bring an additional main battery pack with you on the road.
- ▶ End wireless connections (such as Bluetooth transmission, wireless connection, NFC and GPS) which are not in use.
- ▶ Shorten the screen off time. See [Screen Timeout Settings](#).
- ▶ Reduce the screen brightness level, see [Screen Brightness](#).
- ▶ If you have had your Google Account signed in on this device, you could turn off certain automatic data syncing of applications (such as Email, Calendar, and Contacts). Go to

[App Drawer](#) | **Settings**  | **Accounts**  | **your Google Account**  |

Account sync  and disable the data syncing services of your desired items.

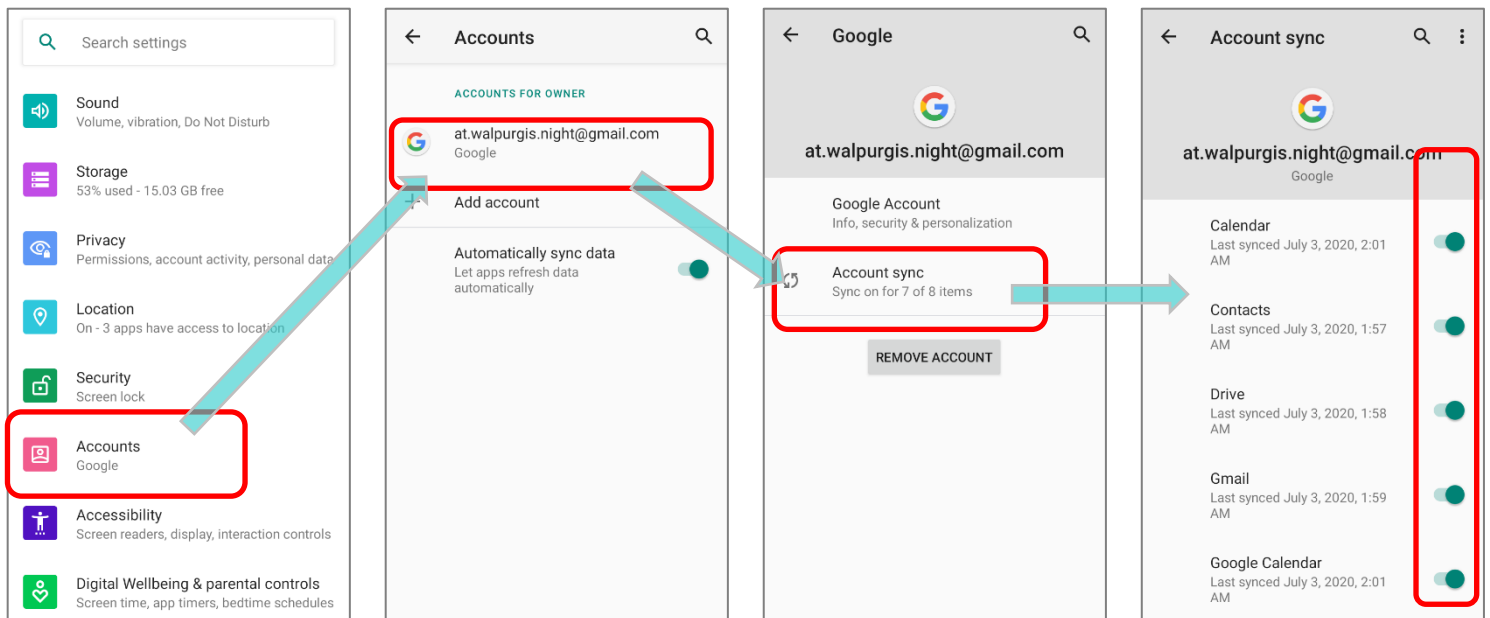

- ▶ Enable **Battery saver** mode and **Battery optimization** mode. See [Battery Saver Mode](#) and [Battery Optimization](#).

ENTER AIRPLANE MODE

You can enable **Airplane** mode to have all the wireless radios (including call functions, data connections such as Bluetooth, Wi-Fi and 3G/4G) on your mobile computer turned off, which will considerably reduce the power consumption of your battery.

To enter **Airplane** mode, please:

- 1) Swipe down from the top of the screen to open [Quick Settings Menu](#).
- 2) Tap on the **Airplane** mode icon to enable/disable the mode.

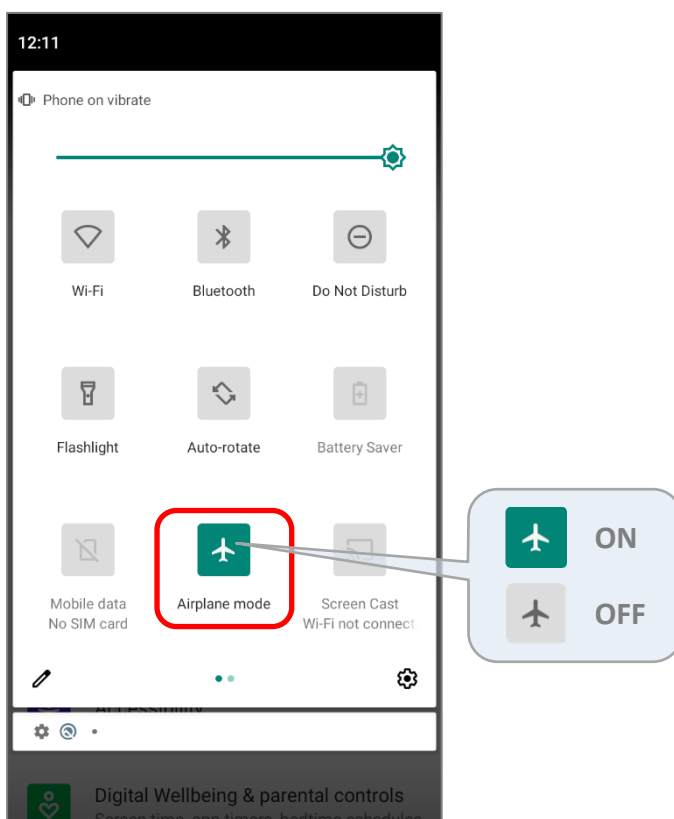

2.1.5. BATTERY PRECAUTIONS



To preserve battery life and avoid battery bulge:

- 1) Please do not use your device while continuously connected with a power supply or cradle for charging. If you need to use your RS35 mobile computer with a power supply or cradle continuously connected, be sure to turn on "**Balance Mode**".
- 2) If the main battery is fully charged, do not keep connecting your RS35 mobile computer with charging it a power supply or cradle for charging. If you need to continuously connect your RS35 mobile computer with a power supply or cradle, be sure to turn on "**Balance Mode**".

BATTERY MODE SELECTION

If you need to use RS35 mobile computer while charging, or if the device needs to be connected with the power supply for charging all the time, it is suggested that switching on "**Balance Mode**" for battery life.

The default battery mode is set to be "Balance Mode". To switch between "Balance Mode" and "Performance Mode":

- 1) Go to [App Drawer \(All Apps\)](#) | **Settings**  | **Battery** .
- 2) Tap on "**Battery Mode Selection**".

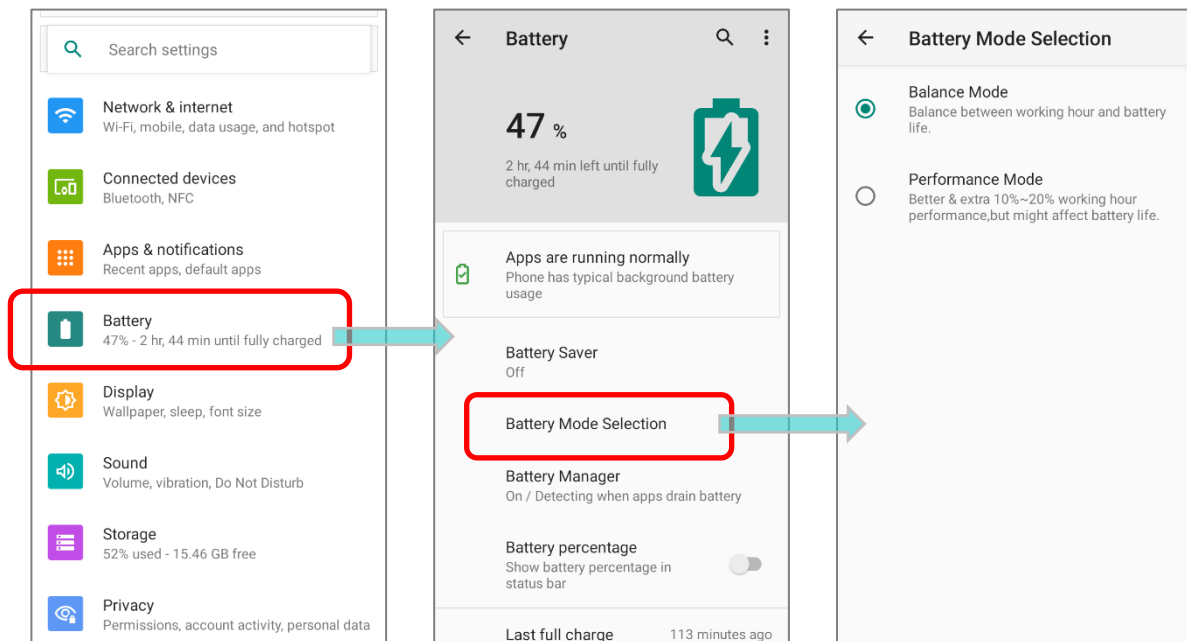

3) Tap on the radio button to select "**Balance Mode**" or "**Performance Mode**".

Tap to set the battery mode. ←

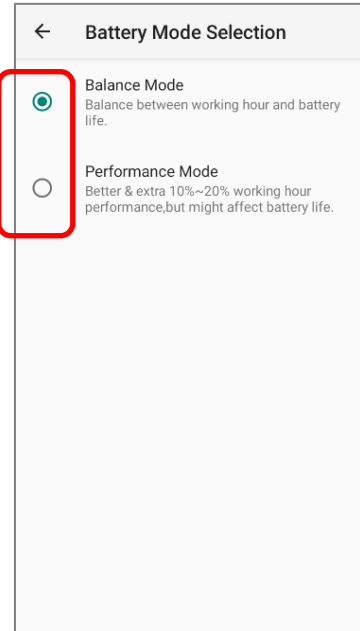

Mode	Description
Balance Mode	Balance between working hour and battery life.
Performance Mode	Better & extra 15% to 25% working hour performance, but might affect battery life.

4) Once you change the mode, a pop-up message appears to indicate the device needs to reboot to make the change take effect. Tap on "**OK**" to confirm, and the device will automatically shut down and reboot.

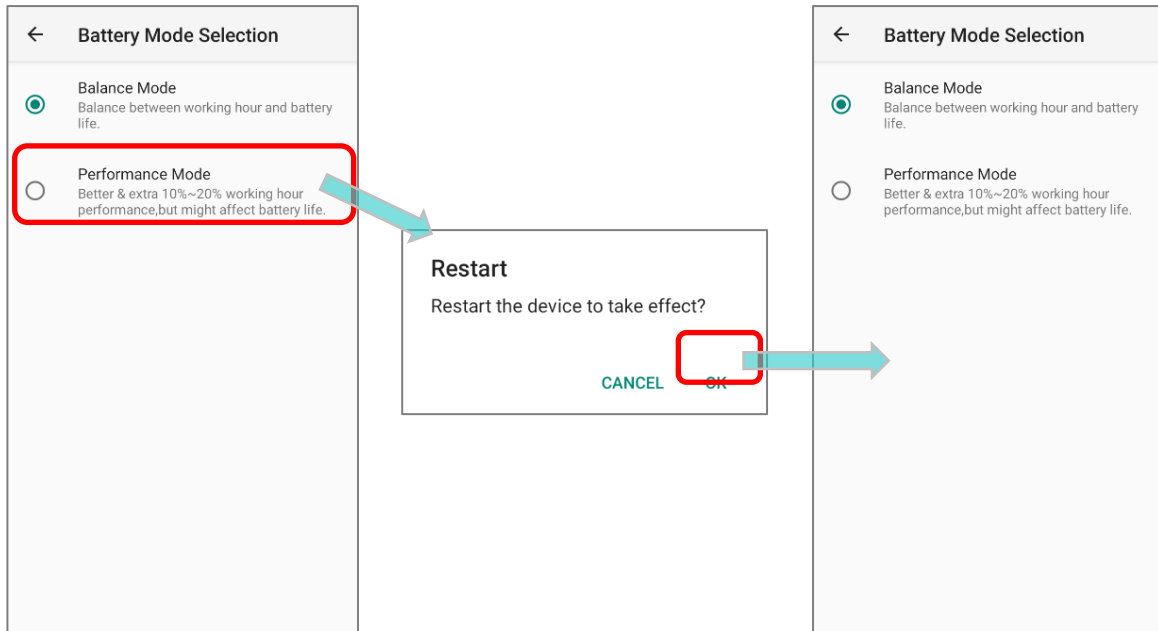

BATTERY TEMPERATURE ANOMALY

High ambient temperature or keeping using RS35 mobile computer while charging might result in battery temperature rises. RS35 mobile computer will automatically suspend charging battery or shut down for safety purpose. Once the battery temperature cools down to normal temperature, battery charging could be proceeded again.

The warning “**Over Battery Temperature**” shows up to instruct you to remove the battery if the temperature of the RS35 battery reaches **55°C** while it prompts to automatically shut down if the temperature of the RS35 battery reaches **60°C**.

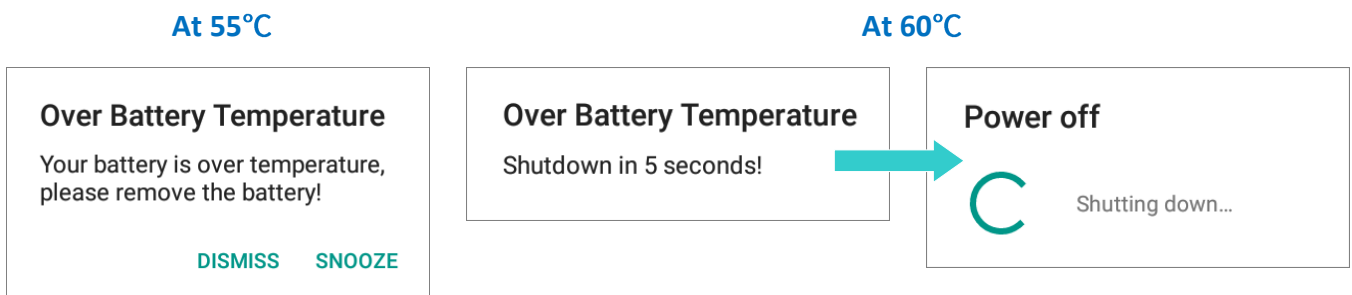

Using RS35 mobile computer under low-temperature environment may cause the device shut down automatically. If the battery temperature is at **0°C** or even lower than **0°C** while charging, the red Status LED in the front panel blinks with a warning window popup to remind the user to disconnect the charger, and RS35 mobile computer will automatically suspend charging the battery.

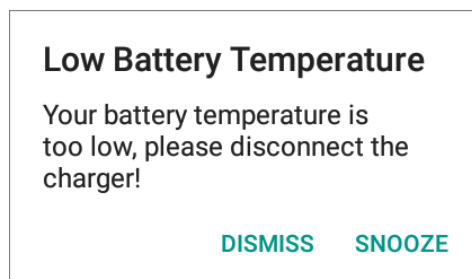

For battery life, please unplug the charger immediately and charge your RS35 mobile computer under appropriate temperature conditions.

2.2. MEMORY

▶ **Flash Memory (ROM)**

32GB flash memory for storing the OS (Android 10 and custom application programs).

▶ **Random-access Memory (RAM)**

3GB RAM for storing and running programs, as well as storing program data.

▶ **Expansion Slot**

The mobile computer is equipped with one SD card slot which can accommodate a micro SD card, a **microSDHC** (up to **32GB**) or a **microSDXC** (up to **64GB-2TB**). When choosing an SD card for best compatibility and performance with RS35, please make sure of the capacity you need. For the use of SDXC card, please use a new card and make sure it has not been used in other host devices (computers, cameras, or readers).

CAUTION OF DATA LOSS

When the main battery is removed or drained, the backup battery on the main board takes over to supply the mobile computer and keep it in suspension. A fully charged backup battery will retain the data in the RAM for **5 minutes**. When the backup battery is drained out as well, the mobile computer will shut down, and only the contents of RTC will be retained (RTC retention will be maintained for at least 72 hours). All other unsaved data will be lost.



If you want to put away the mobile computer for a couple of days, you should be aware that data loss occurs when the main battery and backup battery discharges completely. Therefore, it is necessary to backup data and files before putting away the mobile computer.

2.2.1. CHECK MEMORY USAGE

The memory manager can offer a glance of how the device is using its RAM.

ENABLE DEVELOPER OPTION

To check the memory usage, you have to enable **“Developer Option”**:



- 1) Go to **App Drawer (All Apps) | Settings**  **|About Phone** .
- 2) Tap on **“Build number”** 7 times to enable it. During the process, you’ll see a prompt with a countdown reading **“You are now X steps way from being a developer.”**

- 3) Once the prompt **“You are now a developer!”** showing up, you have succeeded in entering developer mode.

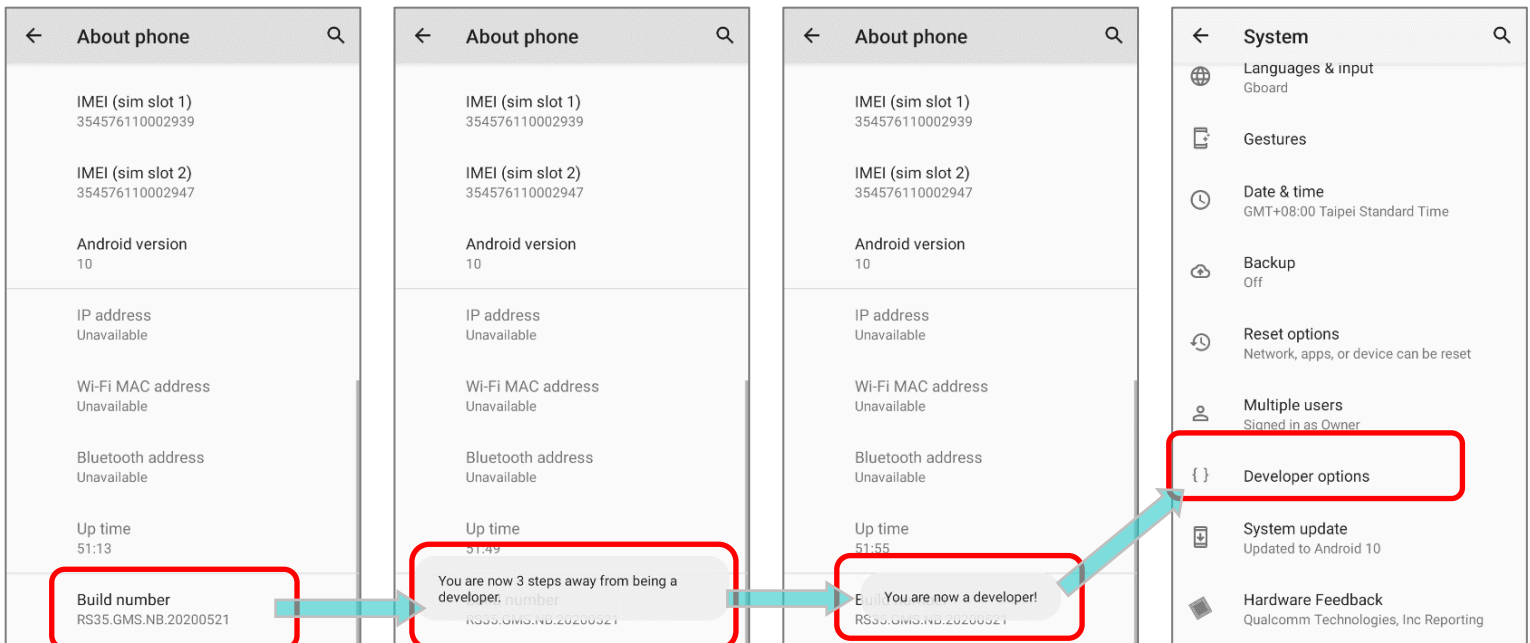
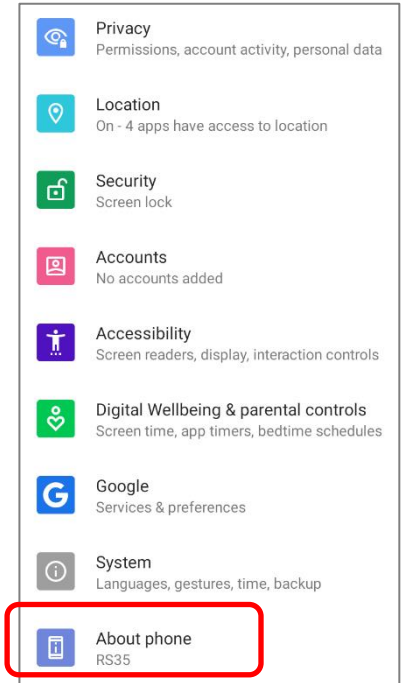
You can find Developer option { } is now enabled in **System**  page.



CHECK MEMORY USAGE

Go to [App Drawer](#) | **Settings**  | **System**  | **Developer option** { } | **Memory**  to enter memory manager screen.

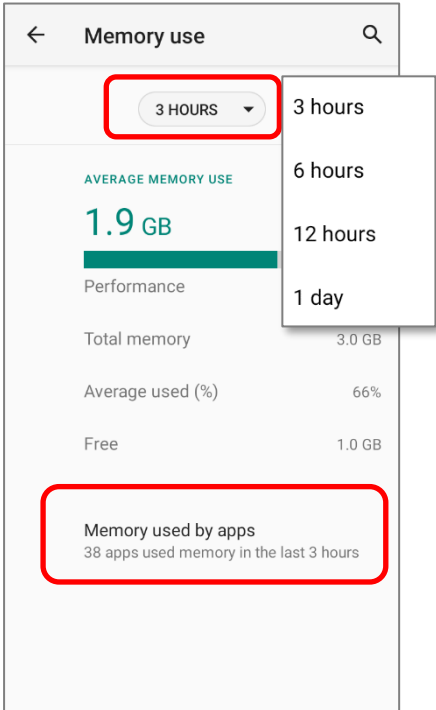

On the main screen, it tells you not only the used and free memory space of the RAM, but how your pattern of usage has impacted the device's overall performance. To figure out how the system and apps have been taking up the memory over a longer period, tap the dropdown list to choose a different time span.

To look at how individual apps are consuming the memory space, tap "**Memory used by apps**" to get a breakdown of memory usage by apps.

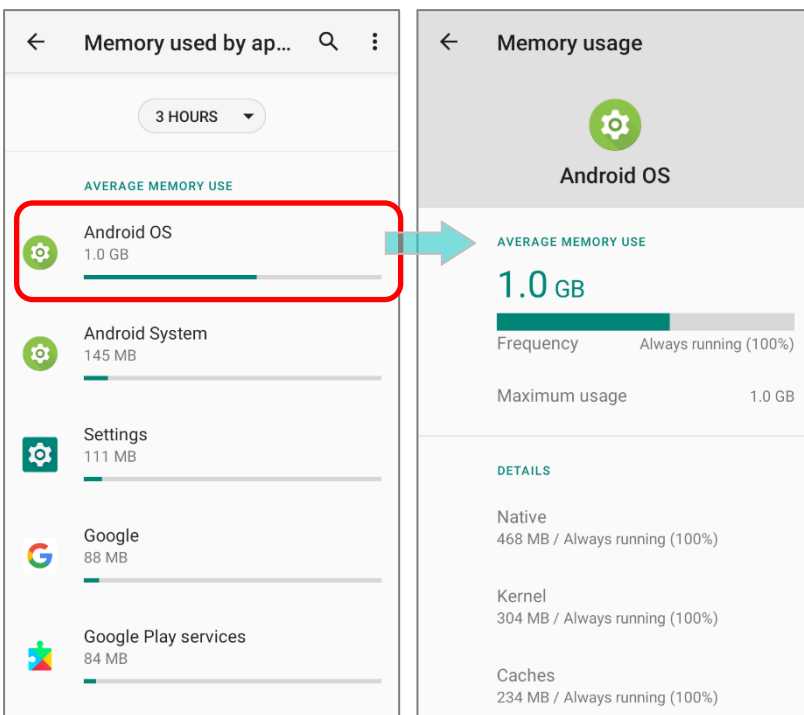

Tap an application name to check its memory usage. This allows you to make sense of how much memory a newly-installed application can potentially consume your RAM.

2.2.2. MANAGE STORAGE SPACE

To your Android device, the SD card can serve as an extension of your device's internal storage (which comes as 32 GB of flash memory to store the OS, applications and files) other than a portable storage place.

Go to [App Drawer](#) | **Settings**  | **Storage**  to check usage of the internal and external storage spaces.

By default, all the videos, photos and downloaded files are directly saved to the device's internal storage. If you have previously inserted and mounted an SD card as [portable storage](#), you could transfer/save photos & other media in this SD card; if the SD card is set as [internal storage](#), photos, files, and some apps could be moved to the SD card.

▶ SD card as portable storage in Storage Settings page

The SD card is used for moving photos and other media between devices.

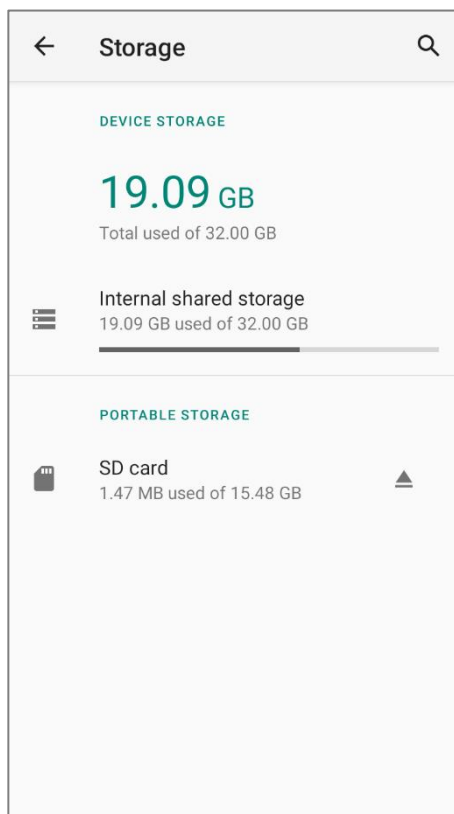

▶ **SD card as internal storage in Storage Settings page**

The SD card is used for storing anything on this device only, including apps and photos.

Requires formatting that prevents it from working with other devices.

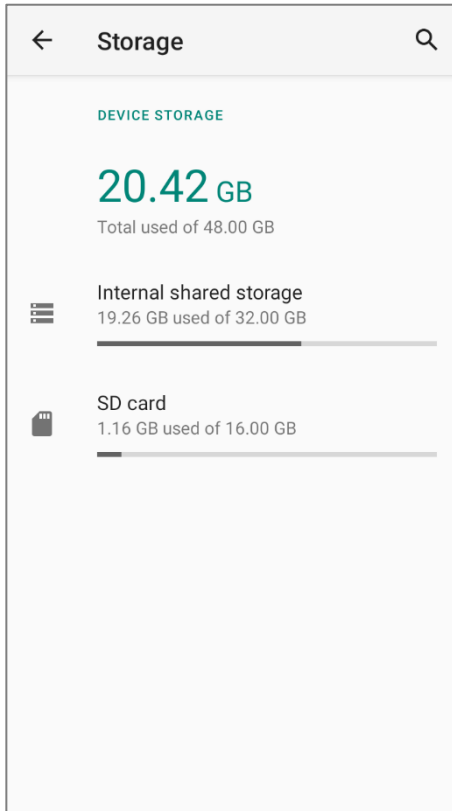

SET UP SD CARD AS PORTABLE STORAGE

Using SD card as a portable device allows you to treat it as a USB disk, by swapping it between your Android device and the computer to easily transfer files. This is quite handy when there is a need to offload files that are taking up too much storage space.

When this device is connected with PC, the disk content is readable from PC client:

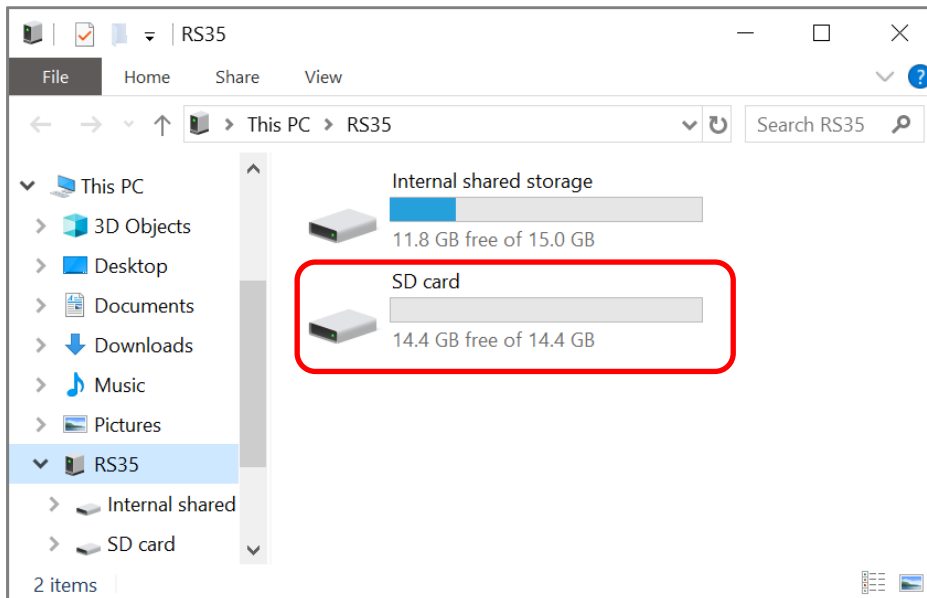

On **Storage** screen, this disk can be managed separately.

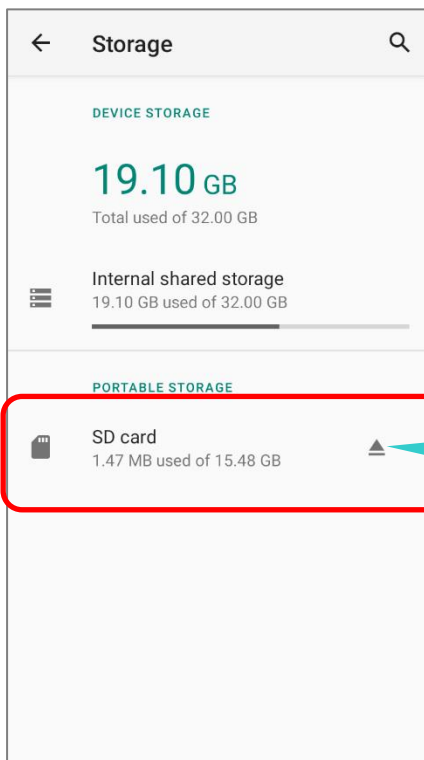

The SD card is considered a separate storage, the capacity of which is not included in total device storage. You can tap  to eject a mounted SD card.

To start:

- 1) Insert the SD card. A notification icon  indicating that an SD card is detected will be shown in the status bar; swipe down from the status bar and tap to set up.
- 2) Tap "**Portable storage**", and complete the setting by tapping "**DONE**".

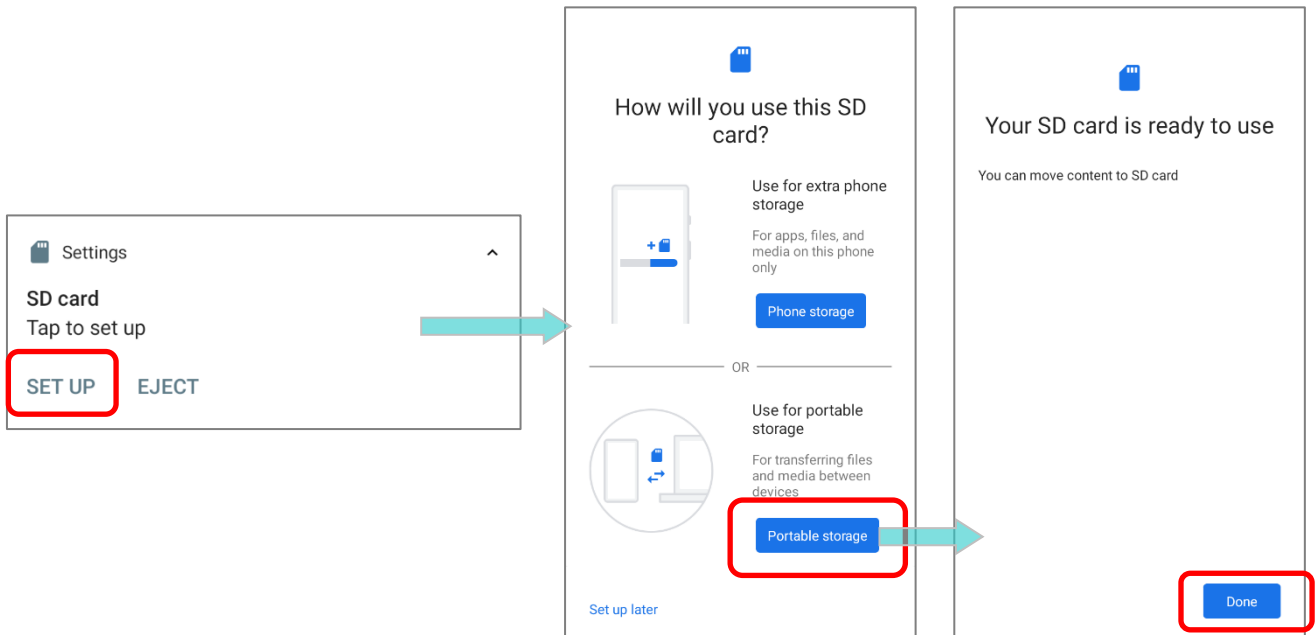

- 3) Swipe down from the status bar to reveal Notifications Drawer, and you will find a notification indicating that the SD card is for transferring photos and media; tap "**EXPLORE**" to check its content.

OR tap the SD card in **Storage Settings** page to check it.

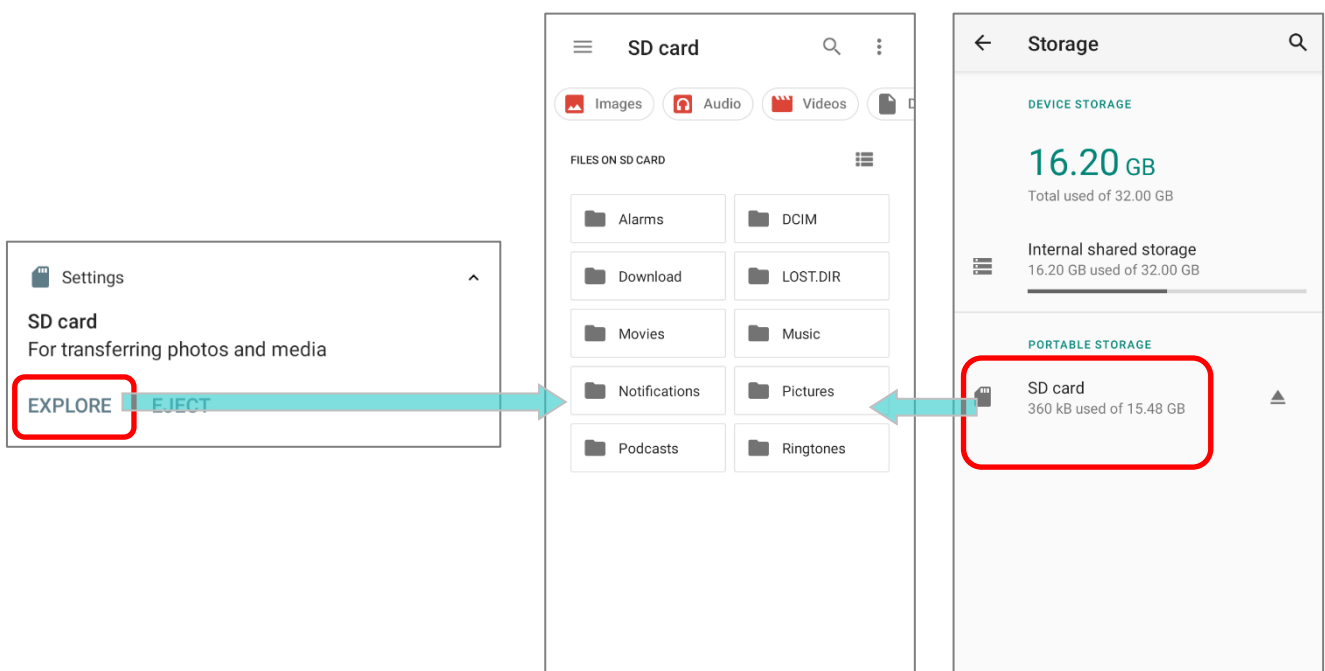

TRANSFER PHOTOS & MEDIA BETWEEN THE DEVICE & PC

To transfer photos and media between this device and PC when the mounted SD card is set as portable storage, please:

- 1) Connect your mobile computer with PC with a USB Type-C cable/ the snap-on cable/ the cradle, and “**USB Preference**” page shows up.
- 2) Choose “**File Transfer**”, and now you will find the disk content is readable from PC client. Please make sure the USB cable is properly connected while transferring files over USB connection.

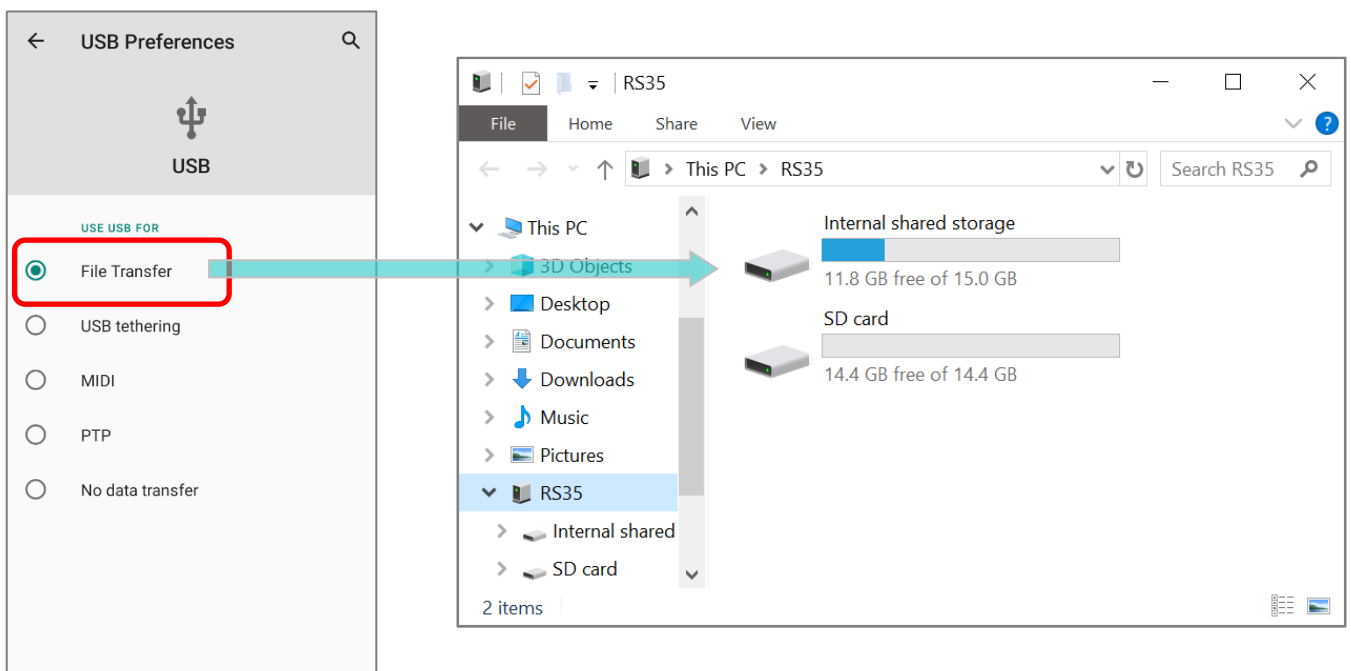

CONVERT THE SD CARD TO INTERNAL STORAGE

- 1) You can always convert the SD Card from portable storage to internal storage. On **Storage** screen, tap the SD card. Before you start, make a backup of the files on this disk if you would like to keep them.
- 2) On SD card content screen, tap **More**  and then tap **"Storage settings"**.
- 3) By selecting **"Format as internal"**, the device will eventually format this SD card into a specific file format only readable by this device.

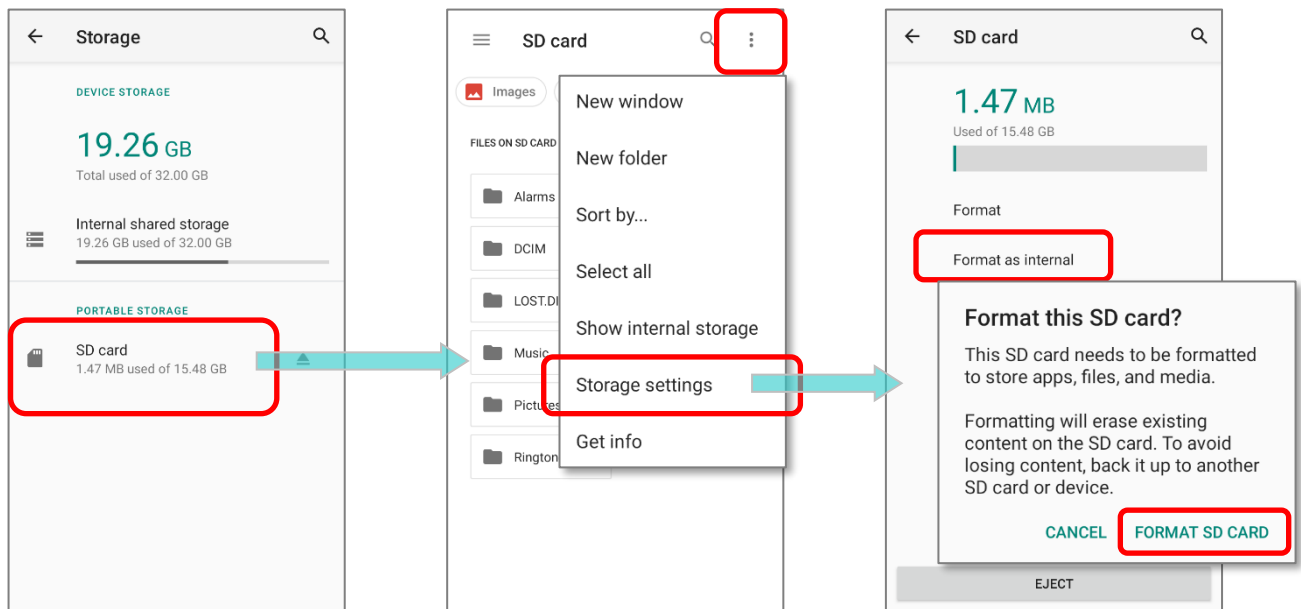

- 4) On **"Format this SD card"** popup, tap **"FORMAT SD CARD"** to format the card.
- 5) You will then be asked whether to move multimedia files to this new SD card right away or later; tap to make your choice.
- 6) When the formatting is completed, tap **"DONE"**.

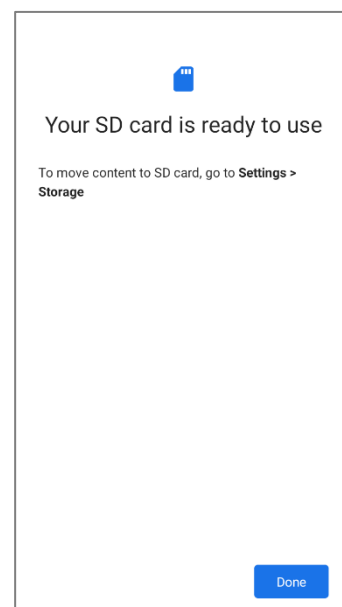
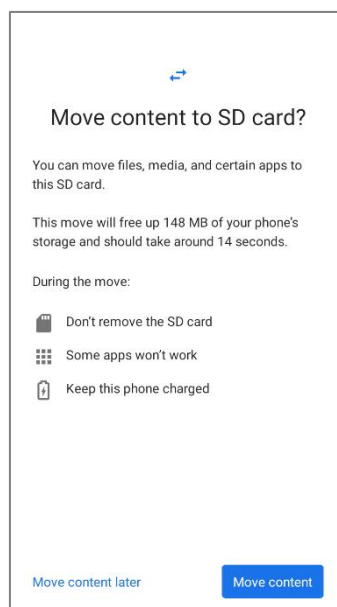
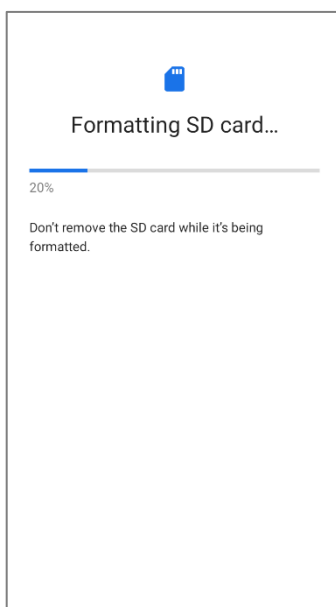

SET UP SD CARD AS INTERNAL STORAGE

Using SD card as internal storage allows you to extend your existing device storage and to store huge applications. This SD card will be reformatted and encrypted with a file format that is not readable by another device. Therefore, it is essential that you back up important files on this SD card in advance. Please note that if you eject this SD card, the applications and media files stored on it will not be available until you reinsert the card.

When this device is connected with PC, the disk content is not readable from PC client:

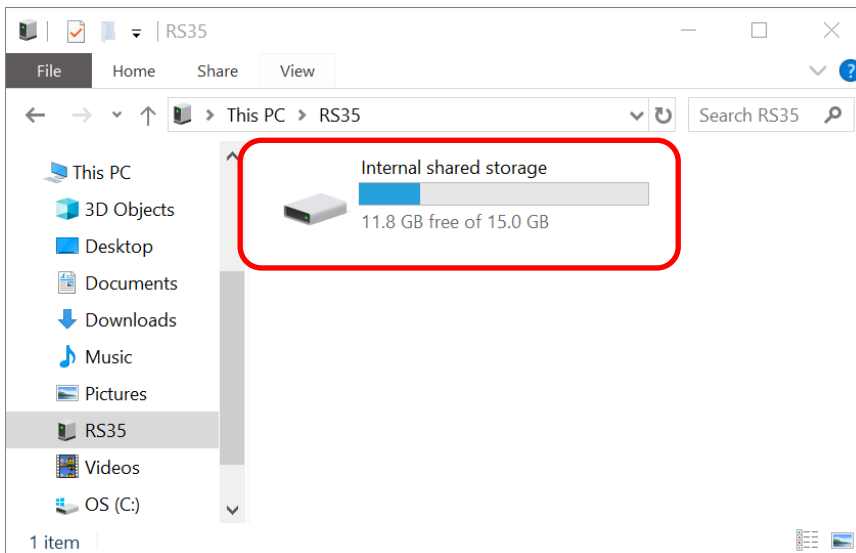

On **Storage** screen, the capacity of this SD card is merged into the total device storage. Please note that. In this setting, you will have no control of which files to be stored on SD card.

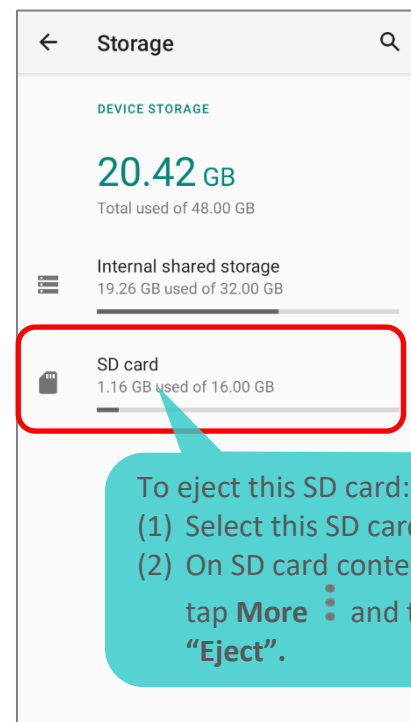

Warning:

Do not physically remove the SD card from the device without ejecting this card in advance.

To start:

- 1) Insert the SD card. A notification will pop up indicating that an SD card is detected tap on **"SET UP"**.
- 2) Tap on **"Phone storage"**.
- 3) On the popup window, select **"FORMAT SD CARD"**.

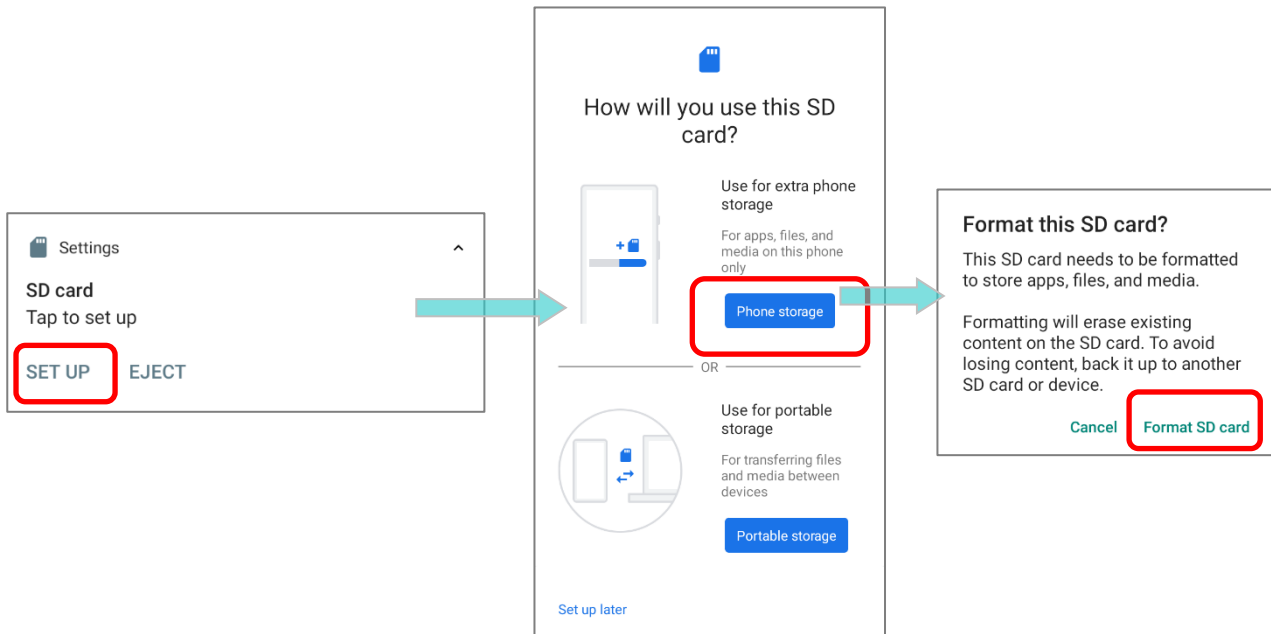

- 4) You will then be asked to whether to move media files to this new SD card, tap to make your choice.
- 5) When the setting is completed, tap **"DONE"**.

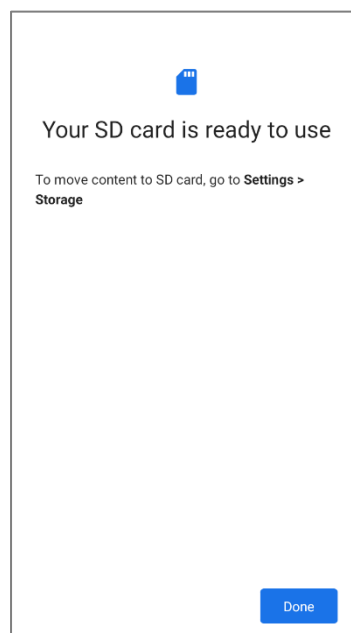
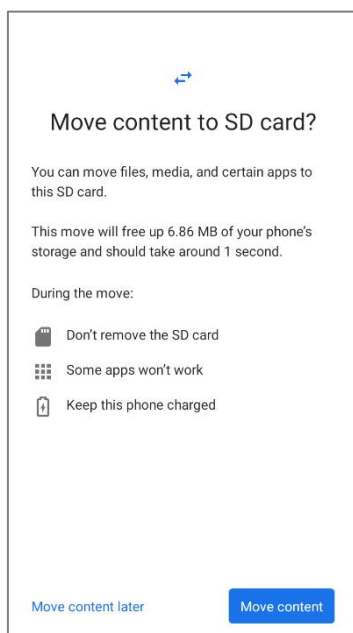

Note:

It is recommended that you select "Move now" at Step 4 to have the device immediately start making use of SD card space. If you select "Move later", the device will continue to consider device's original storage the primary location to save files.

CONVERT THE SD CARD TO PORTABLE STORAGE

- 1) You can always convert the SD Card from internal storage to portable storage. On **Storage** screen, tap the SD card. Before you start, make a backup of the files on this disk if you would like to keep them.
- 2) On SD card content screen, tap **More**  and then tap **"Format as portable"**.
- 3) Tap **"FORMAT"** to have this SD card re-formatted into a file type accessible by other devices.

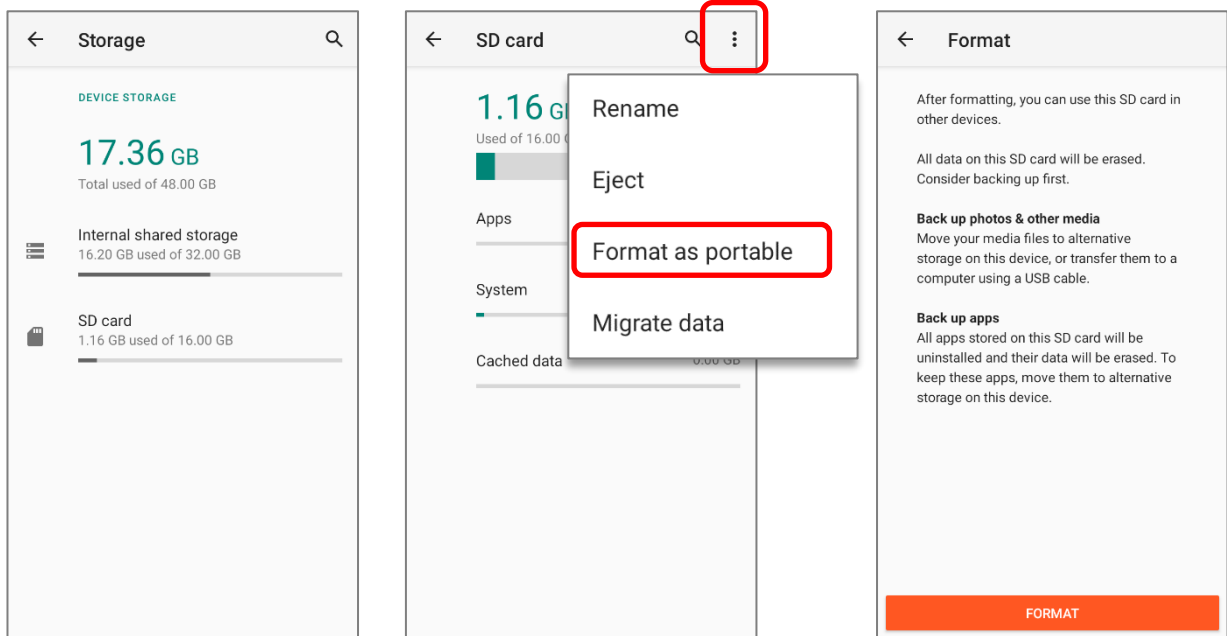

- 4) When the formatting is completed, tap **"DONE"**.

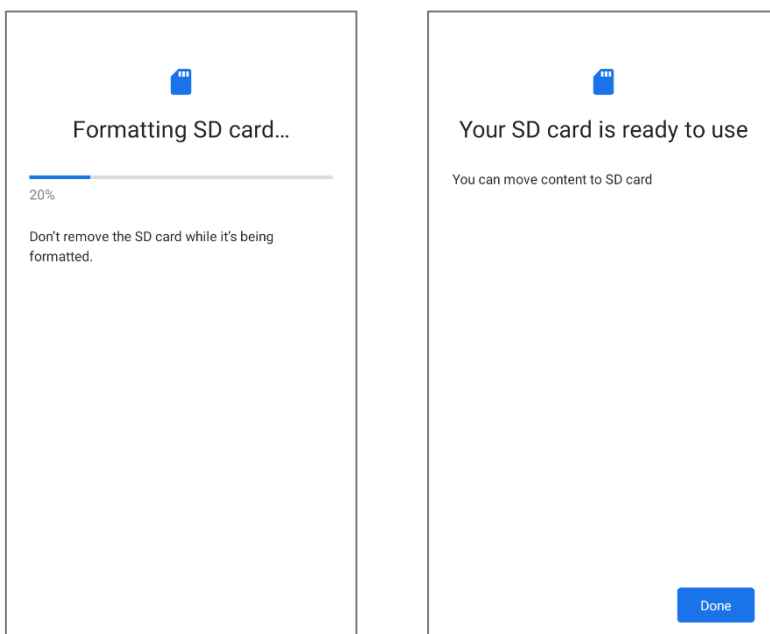

Note:

Please do back up important files on this SD card before proceeding formatting.

2.3. TOUCH SCREEN

The mobile computer comes with a 5.5-inch, transmissive IPS LCD, Corning® Gorilla® Glass 3 display with 720x1440 HD resolution. The LED backlight of the screen, which helps ease reading under dim environments, can be controlled manually and automatically.

Warning: **DO NOT** use any pointed or sharp objects to move against the surface of the screen.

2.3.1. SCREEN BRIGHTNESS

Go to [App Drawer \(All Apps\)](#) | **Settings**  | **Display**  | **Brightness level**.

Adjust screen brightness by dragging the slider to the right (to increase brightness) or left (to reduce brightness). Switch on the **Adaptive brightness** to enable automatic backlight adjustment with the mobile computer's built-in sensor.

You can also use the shortcut button on **Quick Settings Menu** to adjust the brightness level.

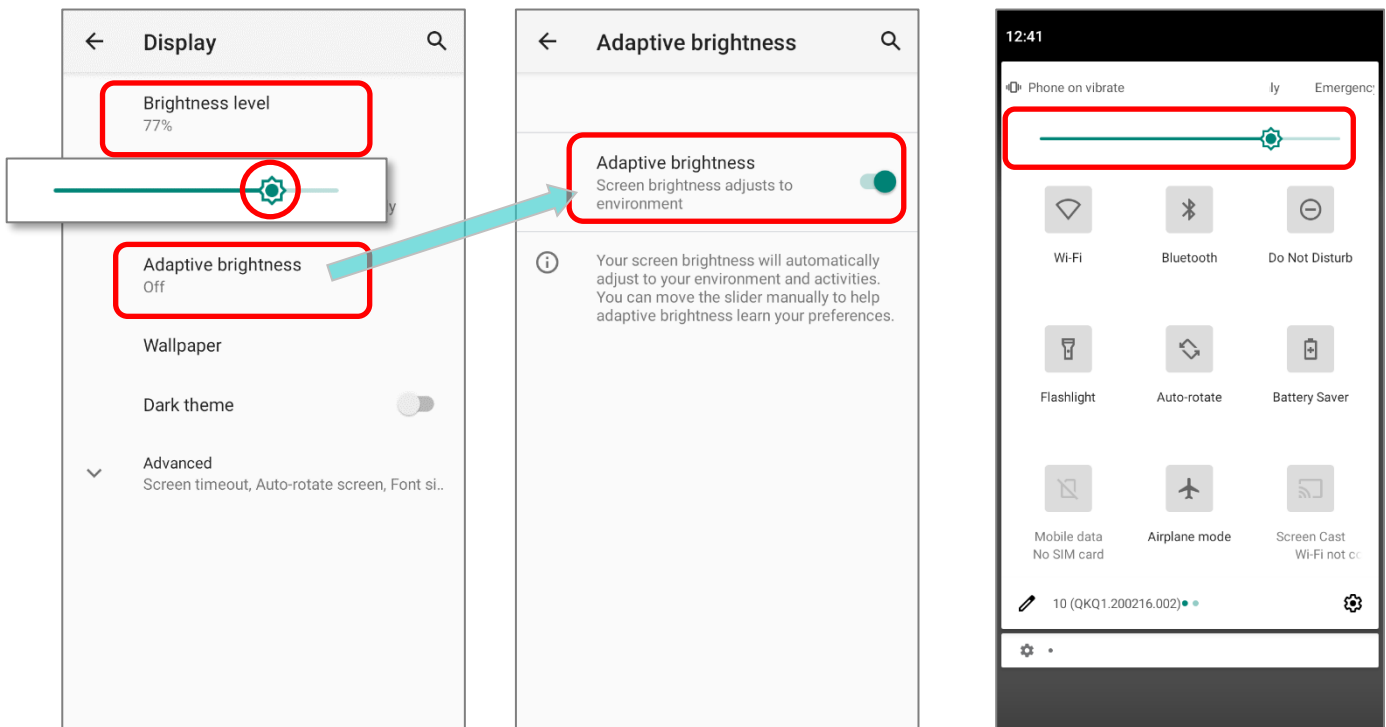



Note:

To save battery power, dim the screen brightness while working in a well-lit area, or set a shorter [sleeping plan](#) for the screen backlight to go off.

2.3.2. SCREEN ROTATION

By default, the device automatically rotates the screen to when you turn the device sideways. To switch this function on or off:

- 1) Go to [App Drawer \(All Apps\)](#) | **Settings**  | **Display** 
- 2) Tap **Advanced** for more display settings, and switch on or off **Auto-rotate screen**.

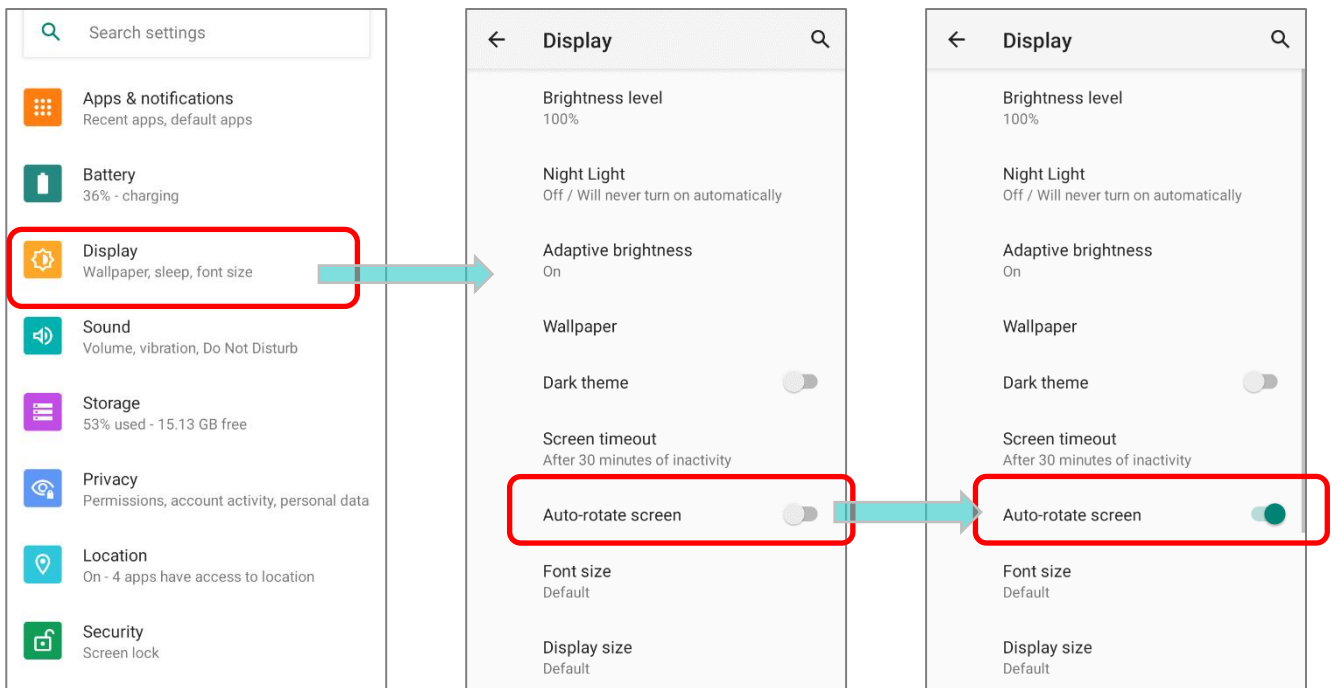

OR swipe down from the top of the screen to open **Quick Settings Panel** or **Quick Settings Menu** and tap the **Auto rotate** icon  to enable screen rotation.

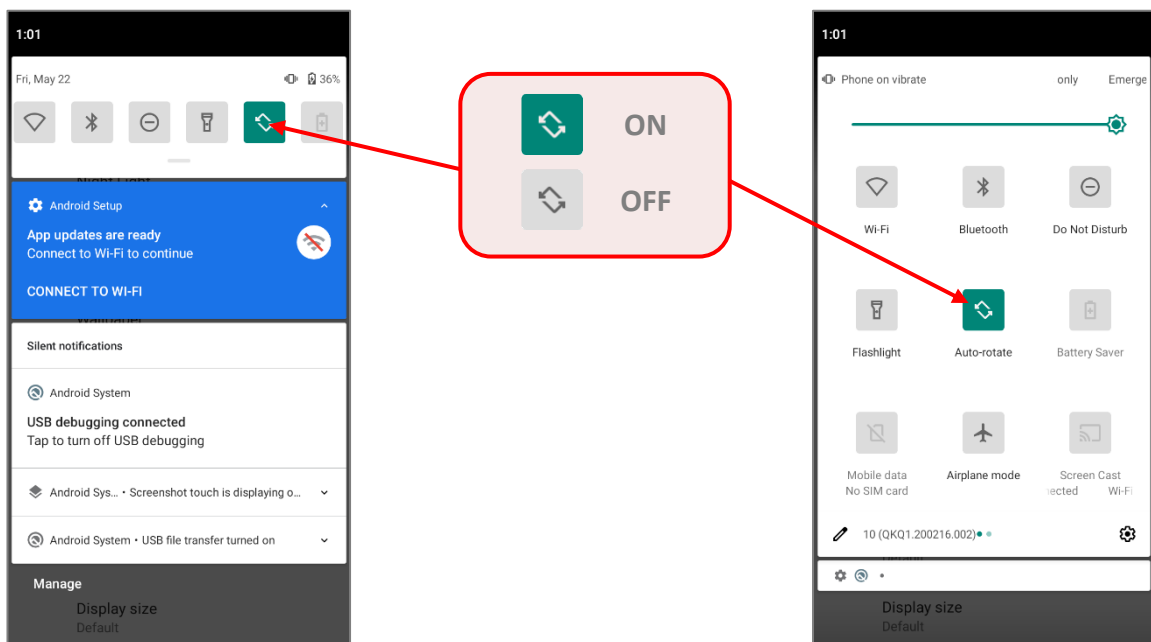

You can enter "Display" page to enable or disable screen rotation by long pressing the **Auto rotate** icon on **Quick Settings Panel** or **Quick Settings Menu**.

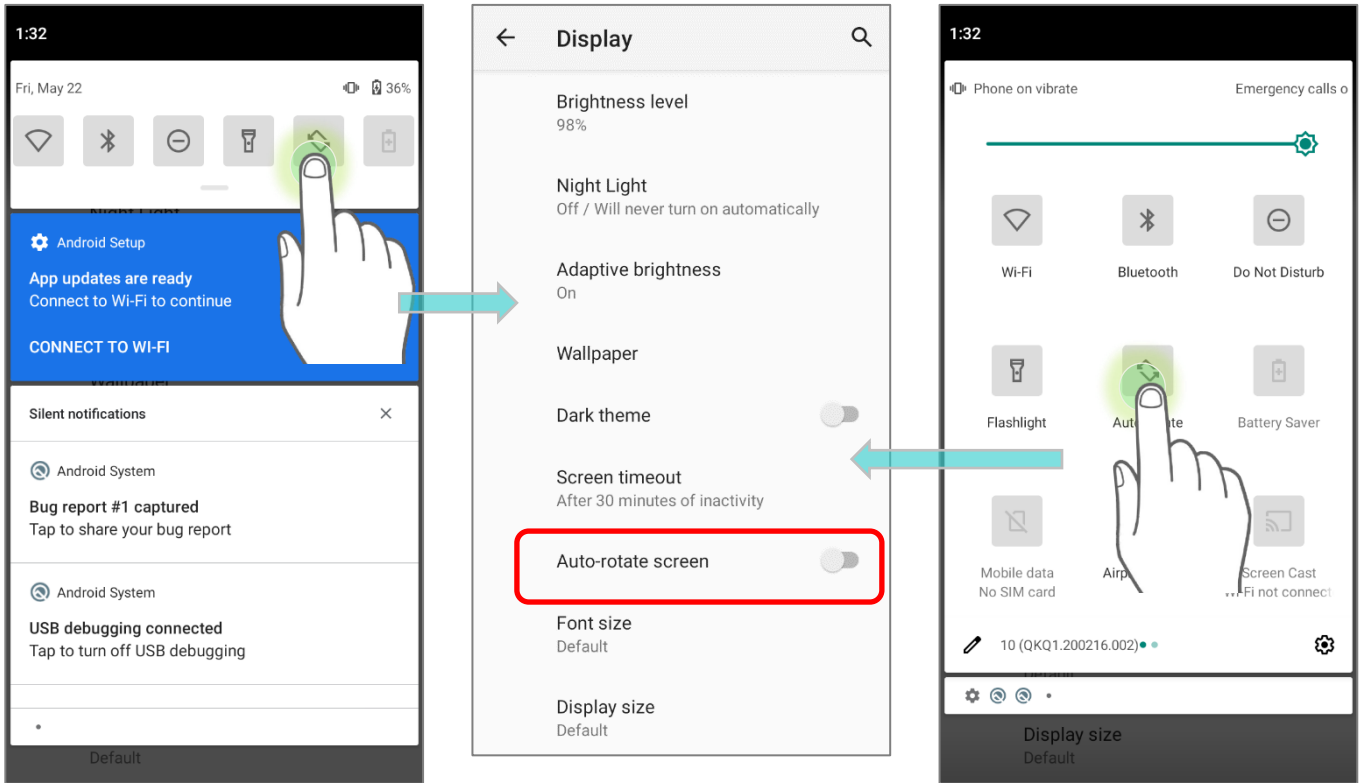

HOME SCREEN ROTATION

To enable Home screen rotation, please make sure **Auto Rotation** is enable.

- 1) Press any empty spot on Home screen.
- 2) Tap "**Home Settings**" and enable "**Allow Home screen rotation**".

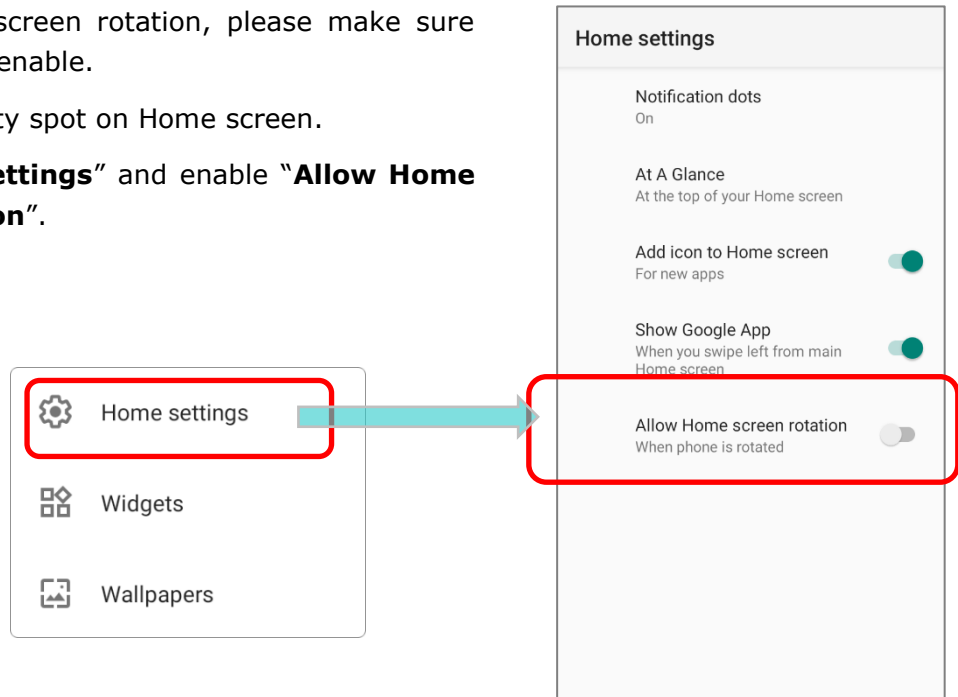



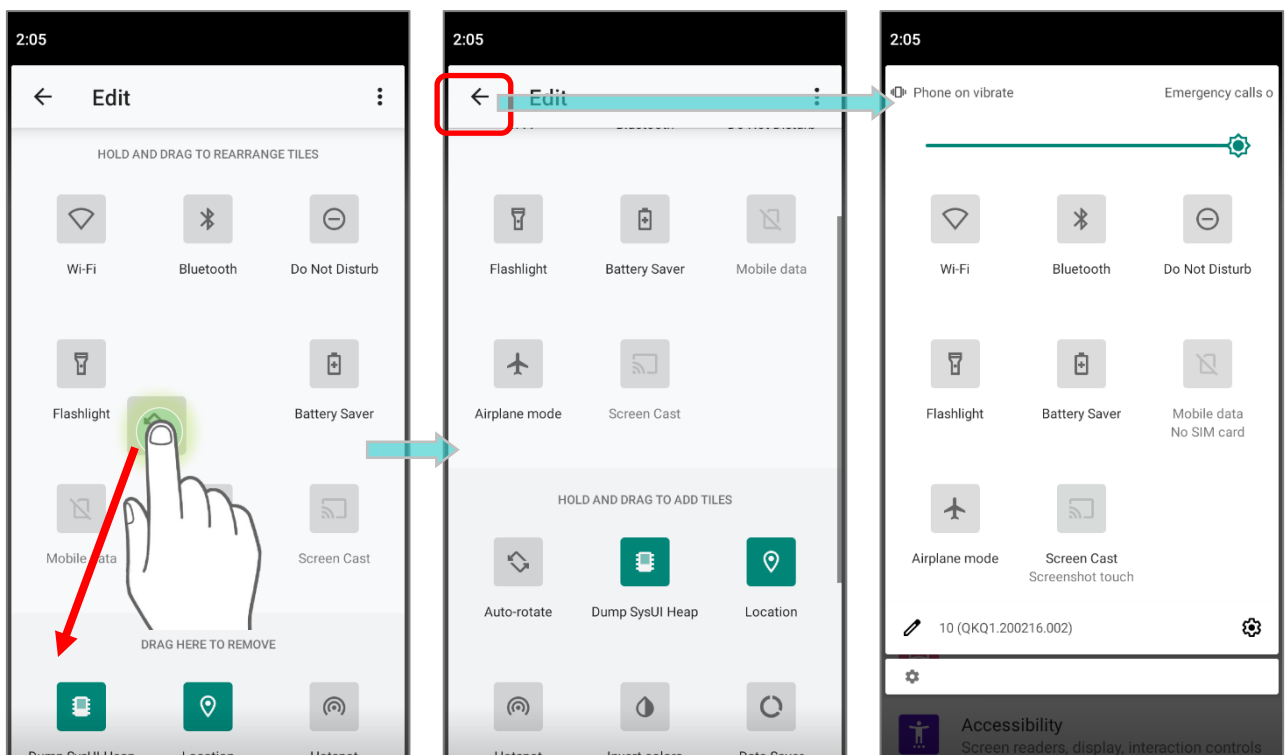
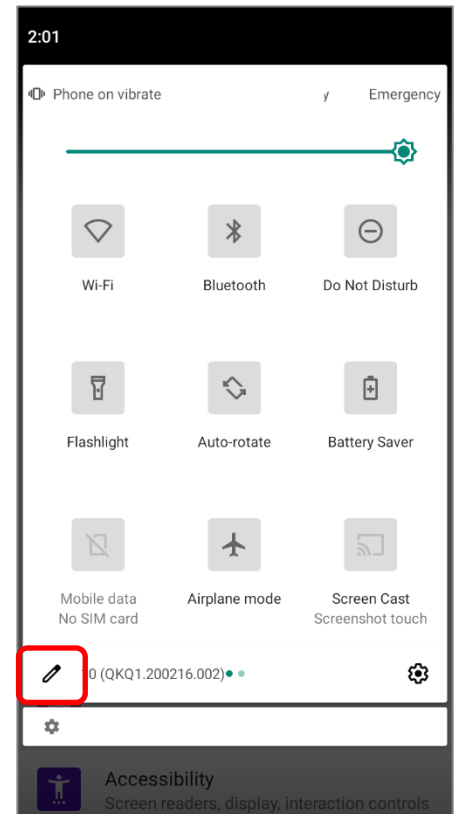

REMOVE AUTO ROTATION FROM QUICK SETTING MENU

You can remove the **Auto rotate** switch icon on **Quick Settings Menu** to minimize the possibility of accidentally turning on the auto-rotation function:

- 1) Swipe down from the top of the screen to open **Quick Settings Menu**.
- 2) Click **Edit** button  to get into **Edit** page; tap on and hold the **Auto rotate** icon, and drag it to the "**Drag here to remove**" area and then release it.
- 3) Return to the **Quick Settings Menu**, the **Auto rotate** switch icon is now hidden.



REMOVE AUTO ROTATION FROM DISPLAY SETTINGS

Go to [App Drawer \(All Apps\)](#) | **Settings**  | **Accessibility**  and switch off **Auto-rotate screen**. By doing so, the auto-rotation option will be hidden in **Settings**  | **Display**  .

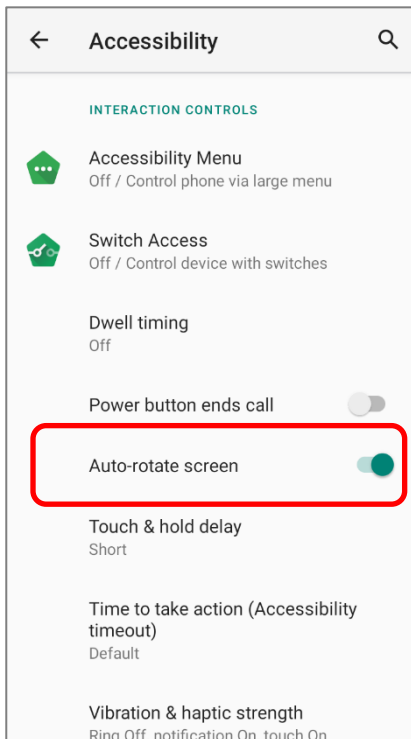

Step 1:

The original “Display” page where the function “Auto-rotate screen” is listed on.

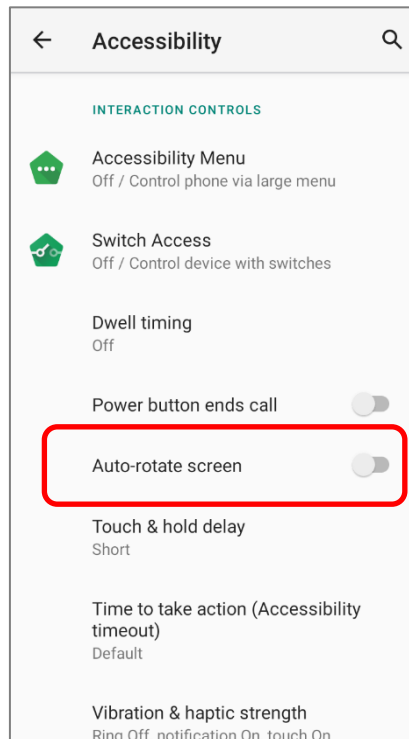

Step 2:

Switch off “Auto-rotate screen” on “Accessibility” page.

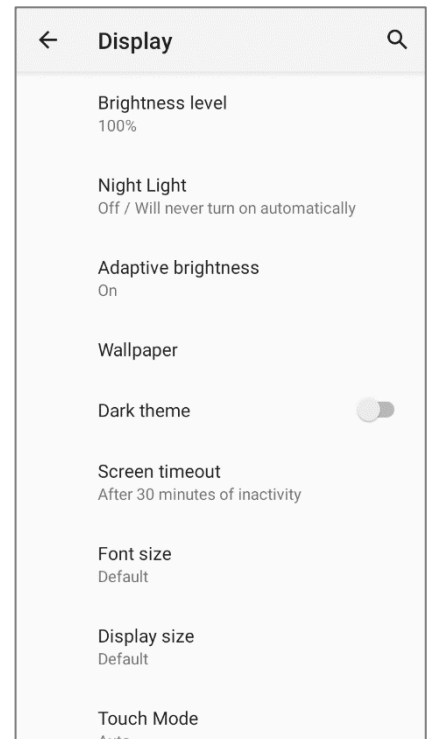

Step 3:

Now the function “Auto-rotate screen” is hidden on “Display” page.

Note:

Auto-rotation is not supported for certain applications. Without enabling “[Allow Home Screen Rotation](#)”, auto-rotation is inapplicable in Home Screen and [App Drawer](#) screen.

2.3.3. SCREEN TIMEOUT SETTINGS

Go to [App Drawer \(All Apps\)](#) | **Settings**  | **Display**  | **Screen timeout.**

Select the time lapse for screen timeout.

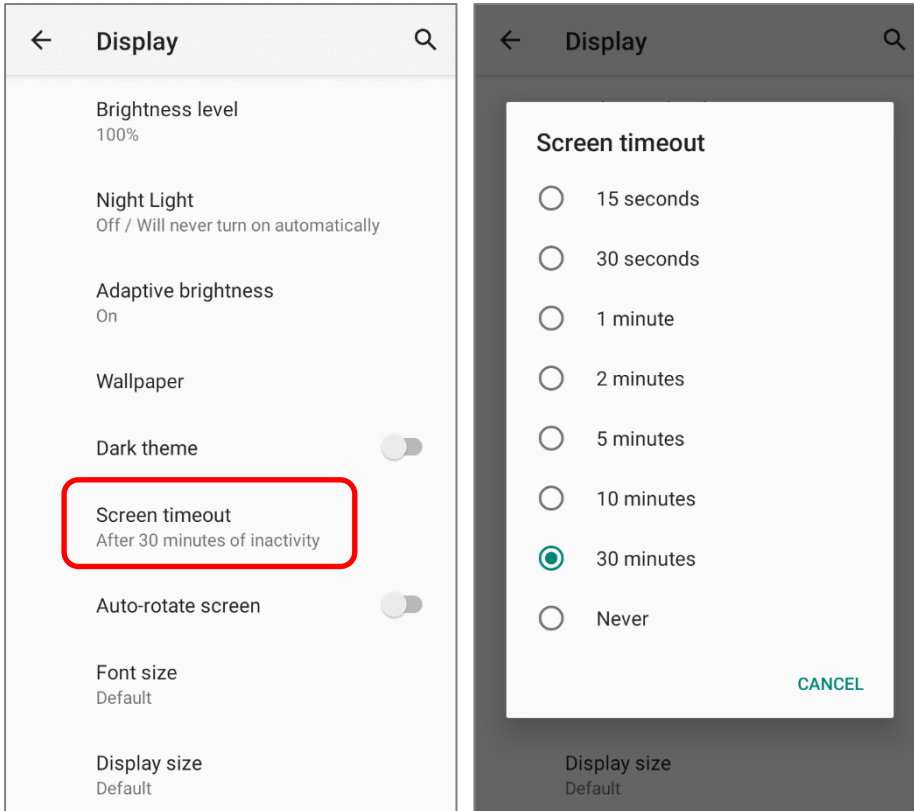



2.3.4. TEXT SIZE & DISPLAY SIZE

Go to [App Drawer \(All Apps\)](#) | **Settings**  | **Display**  | **Font size**.

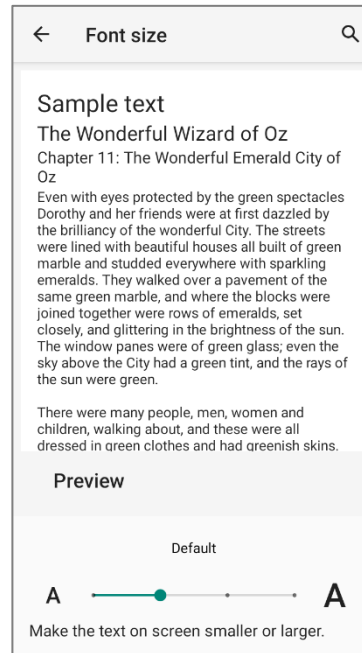
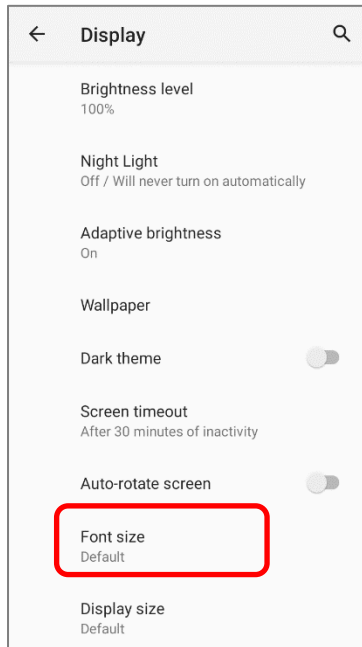
Tap the small A icon  or the large A icon  to select the font size between **Small**, **Default**, **Large** and **Largest**.



Go to [App Drawer \(All Apps\)](#) | **Settings**  | **Display**  | **Display size**.

Tap the plus icon  or the minus icon  to select the display size as **Small** or **Default**.

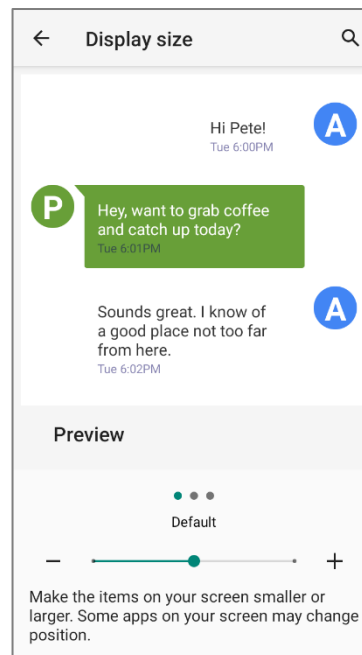
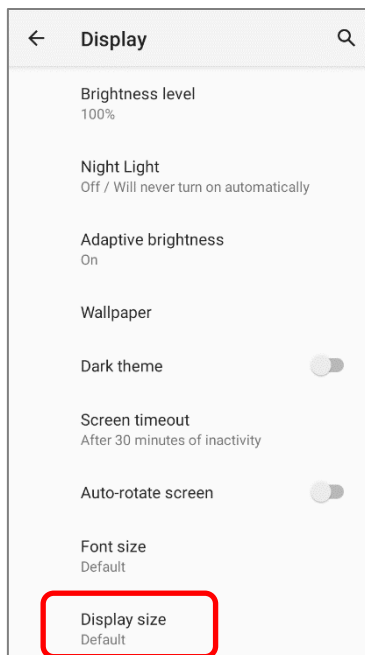

2.4. NOTIFICATIONS

2.4.1. STATUS LED

Two LED indicators located above the touch screen provide information about charging status, scanner light beam, and scanner "**Good Read**" during data collection.

LED 1 for Power Indication		
Indicator	Status	Description
Charging	Green, solid	Charging complete (more than 95%)
	Red, solid	Charging the mobile computer (0% to 95%)
	Red, blinking	Charging temperature error (lower than 0°C or exceed 40°C)

LED 2 for Reader & System Notification		
Indicator	Status	Description
Barcode decode	Green, flash once	Good read
System notification	White, blinking	New notification

Note:

For Scanner decode and Scanner beam LED to function, LED notification must be enabled in the app "ReaderConfig".

2.4.2. AUDIO

The speaker is used to play sounds for events in windows and programs, or play audio files. In addition, it can be programmed for status feedback. In noisy environments, you may consider connecting a Bluetooth headset instead. The mobile computer also supports USB Type-C audio adapter for connecting headsets.

Supported audio file formats include: WAV, MP3, AAC, AAC+, Enhanced AAC+, AU (including ADPCM), Midi, XMF, AMR (NB and WB). Enhanced low delay AAC, FLAC, Vorbis, PCM.



Use the volume buttons on the side of the mobile computer to adjust the system volume.

2.4.3. SOUNDS AND VIBRATION



The mobile computer is integrated with a vibrator, which is software programmable for tactile feedback. This can be helpful when working in noisy environments.

You may also set the mobile computer to vibrate only, in which all system sounds will be muted and replaced by the vibrator.

QUICK SOUND MENU

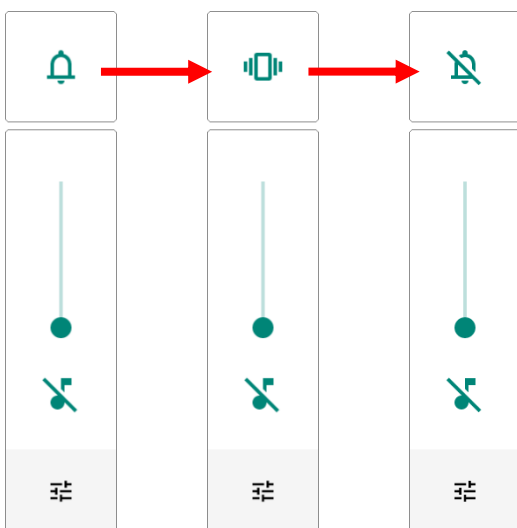
On any screen, press down **Volume Up** or **Volume Down** key to open quick sound menu. Tap on the icon  or  or  to switch between ringing, vibration, and mute.



Item	Description
	Calls and notifications will ring.
	Calls and notifications will vibrate.
	Calls and notifications will be muted.

The media volume can be adjusted by pressing the **Volume Up** or **Volume Down** key, or dragging the slider on quick sound menu.



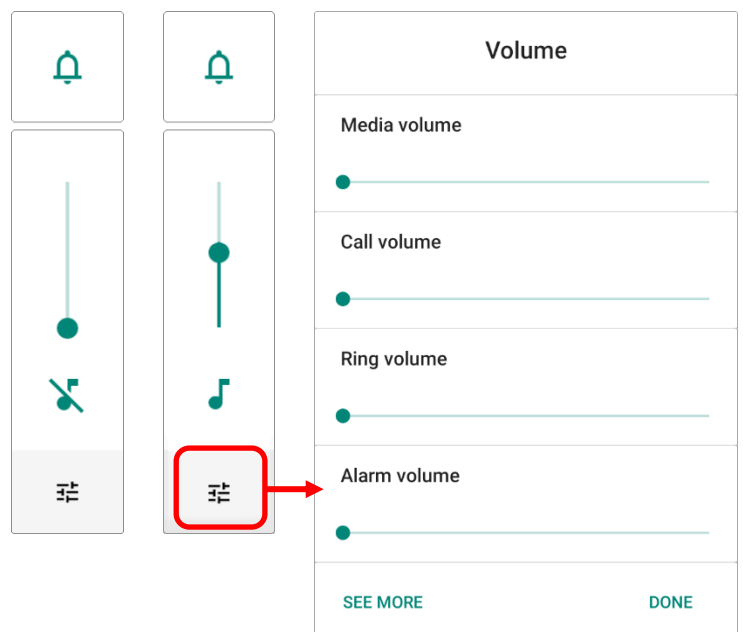



Tap on the settings icon  will open the pop-up volume panel; tap on **"SEE MORE"** will directly enter the [Sound Settings](#) page.



SOUND SETTINGS

Go to [App Drawer \(All Apps\)](#) | **Settings**  | **Sound**  for more sound settings.

On “**Sound**” settings page, you can:

- 1) Adjust the volume for **media** , **call** , **ring** , and **alarm**  by dragging the sliders. The media icon turns to be  if it is off while the ring icons turns to be  to indicates it is off.
- 2) Enter “**Do Not Distrub**” for its detailed settings.
- 3) Set the shortcut to prevent ringing.

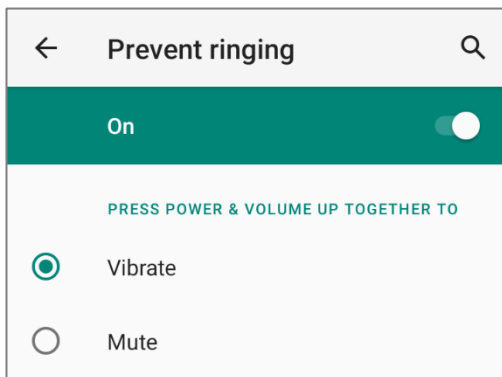

- 4) Select the sound for “**Default notification soud**” and “**Default alarm sound**”.
- 5) Turn on or off the switch of the items under “**Other sounds and vibrations**”.

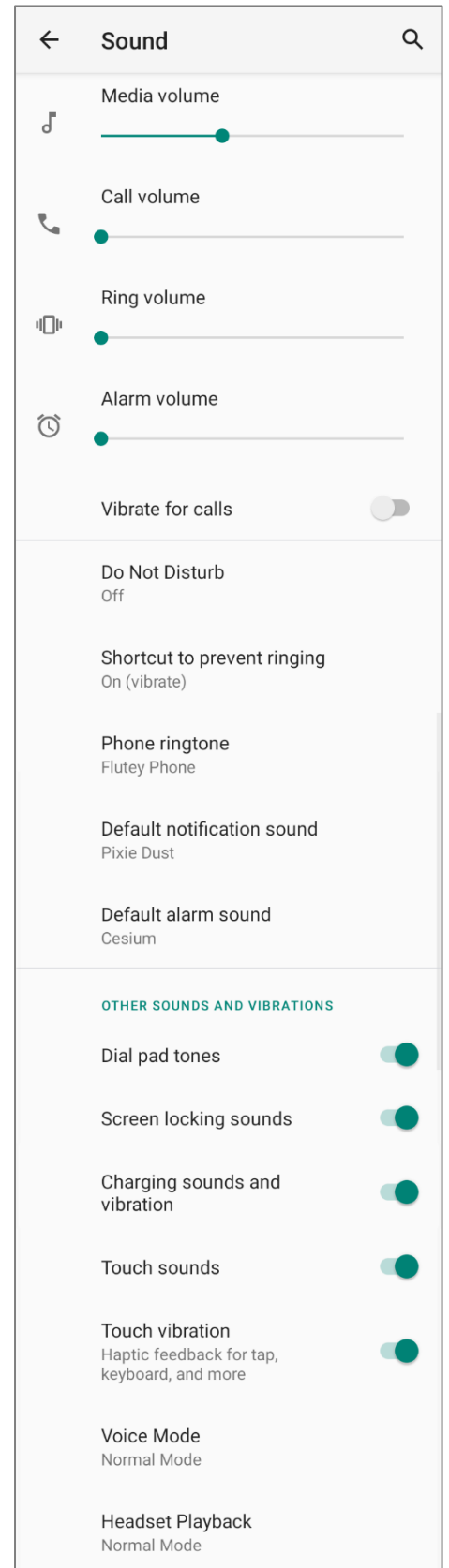

DISABLE UNWANTED NOTIFICATIONS WITH “DO NOT DISTURB”

You can temporarily disable specific notifications (vibration or sound) using **“Do Not Disturb”** in Quick Settings menu. What’s more, you can schedule the duration of the disabled status so that the notifications will switch to enabled state automatically based on your arrangement.

Swipe down from the status bar to open **Quick Settings Panel** or **Quick Settings Menu**, tap on **“Do not disturb”** to enable this feature and make further adjustment.

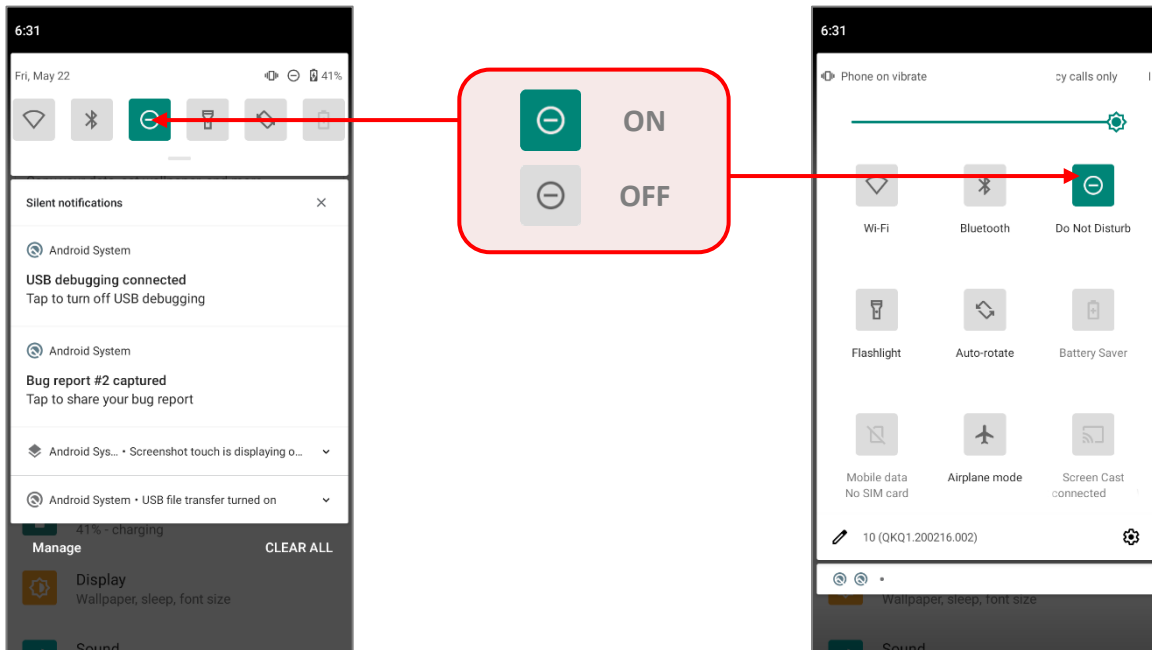

You can enter **“Do Not Disturb”** page for further settings by long pressing the **Do Not Disturb** icon on **Quick Settings Panel** or **Quick Settings Menu**.

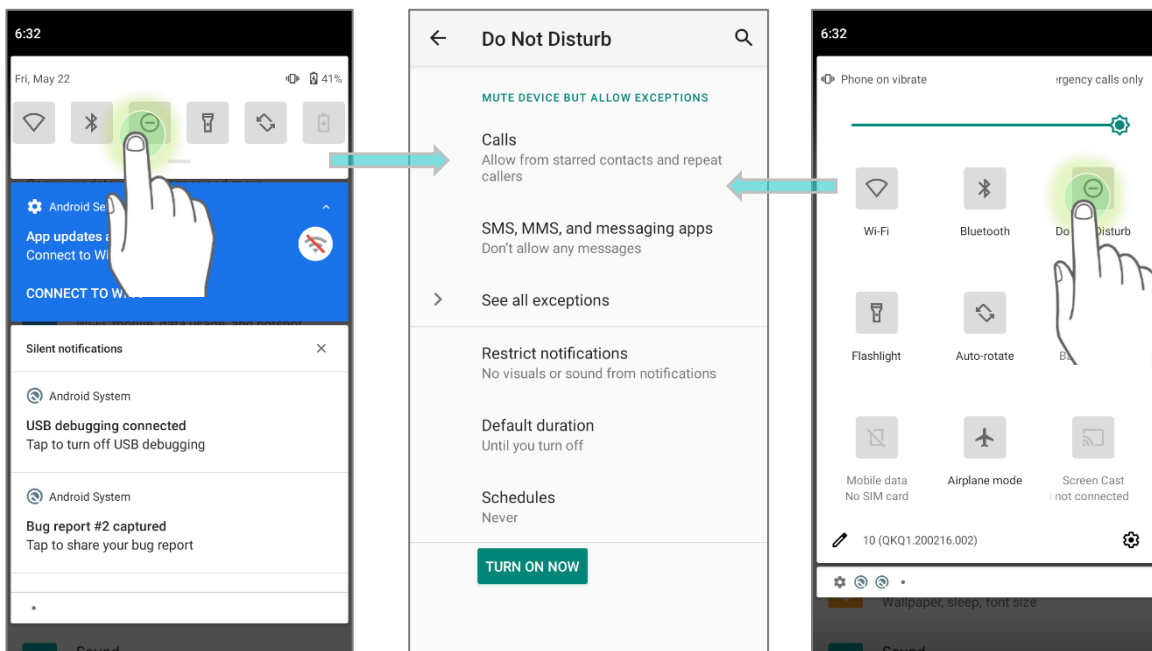

OR

Go to [App Drawer \(All Apps\)](#) | **Settings**  | **Sound**  | **Do Not Disturb**

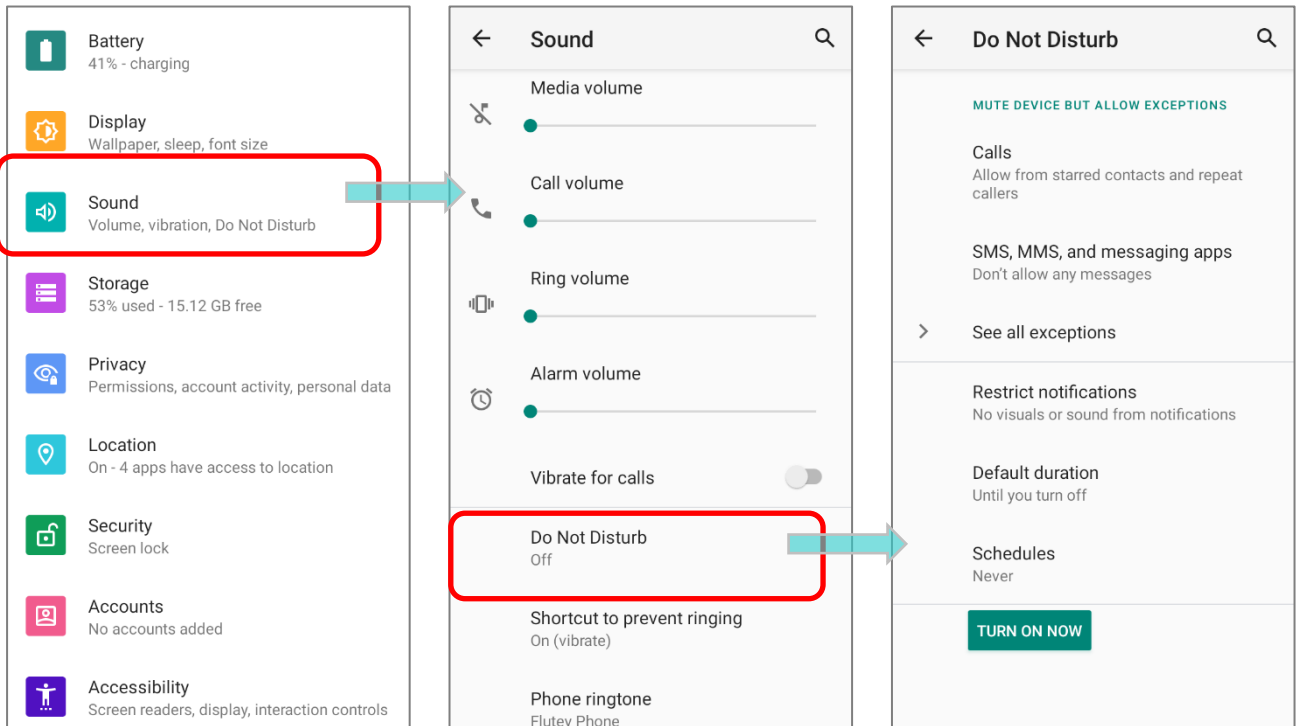

Tap on **"See all exceptions"** to make exceptions while DND is on.

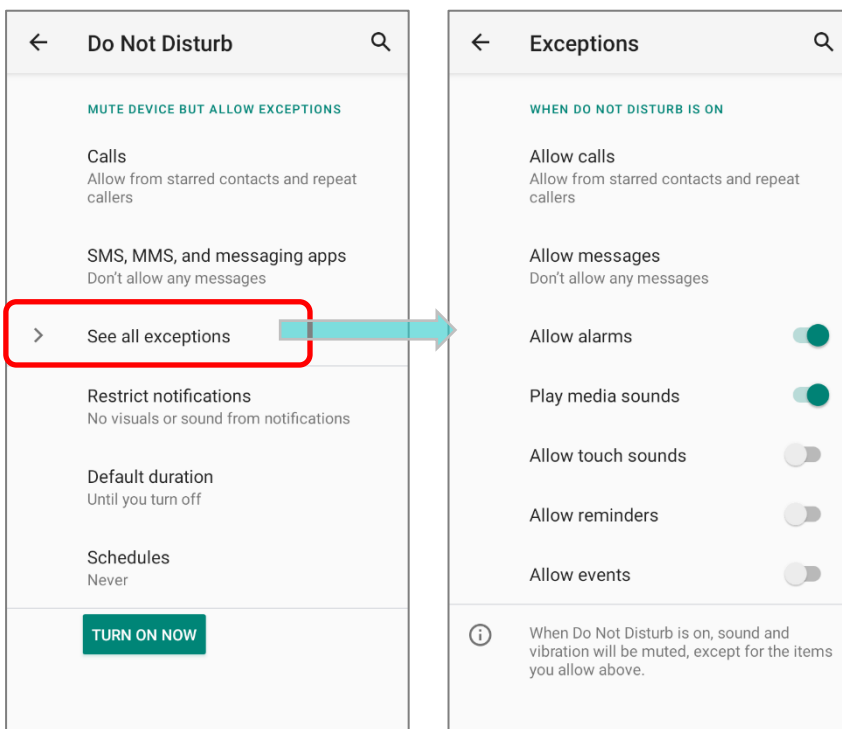

2.5. DATE AND TIME

By default, the mobile computer automatically synchronizes the date and time to the WWAN network (if connected).

To set the date and time manually:

- 1) Go to [App Drawer \(All Apps\)](#) | **Settings**  | **System**  | **Date & time** 

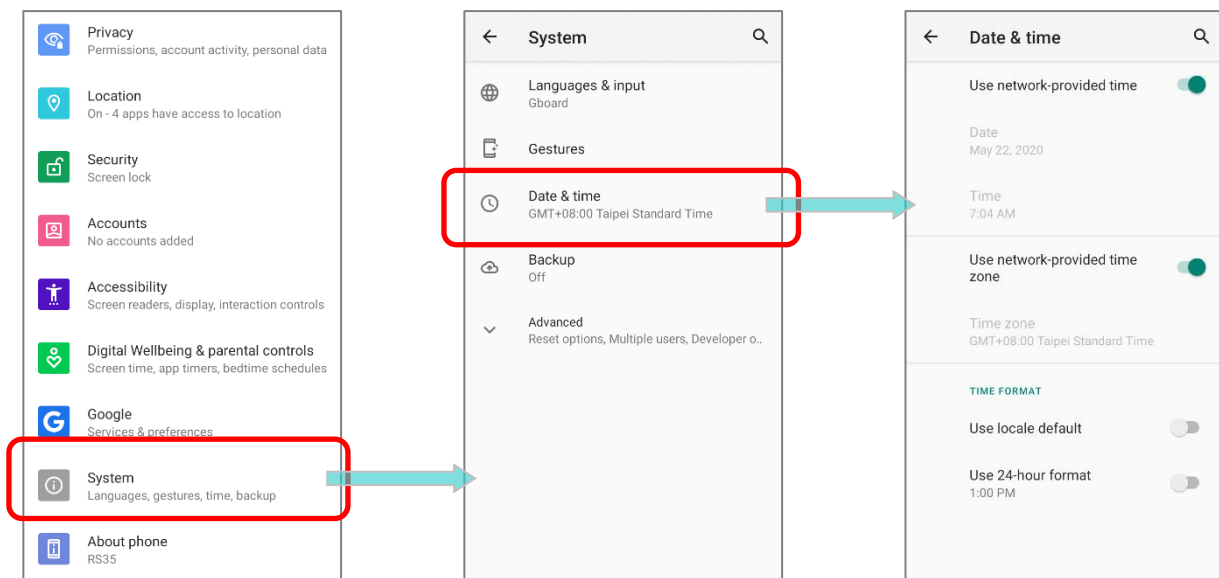

- 2) Tap to turn off **Use network-provided time** to disable using network-provided time.
- 3) Tap **Set date** to select the correct month, date and year. Tap **OK** to save.
- 4) Tap **Set time** to set the correct time. Tap **OK** to save.

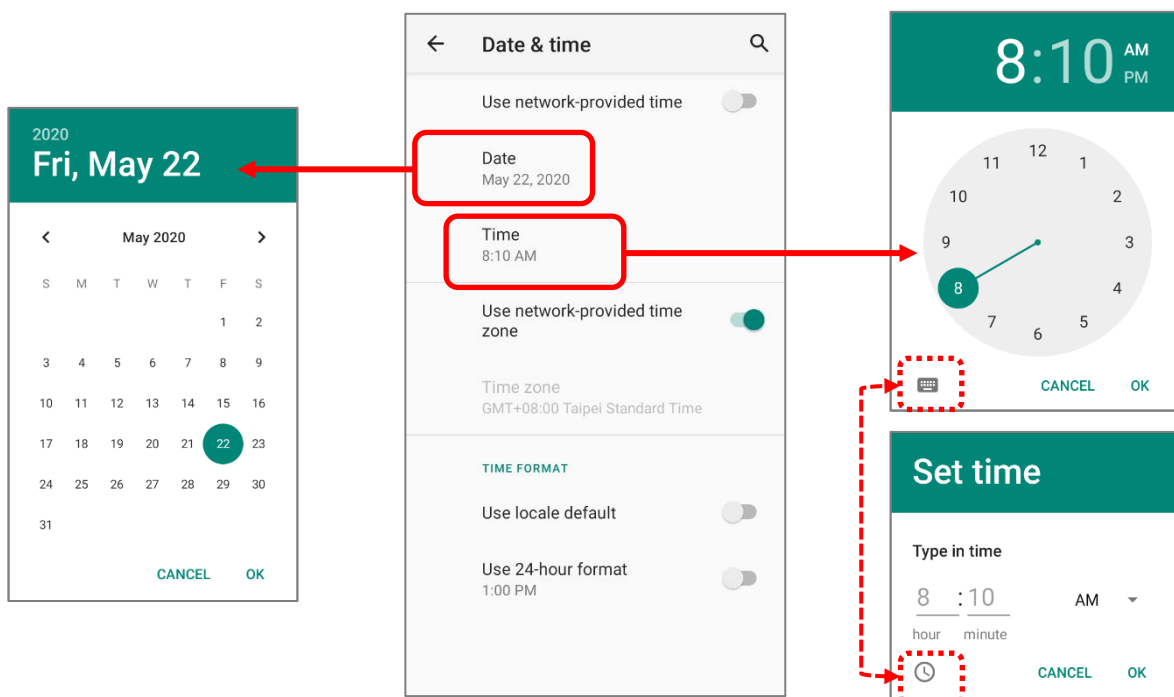

5) Disable **Use network-provided time zone** and then tap **Time zone** to select the correct time zone from the list.

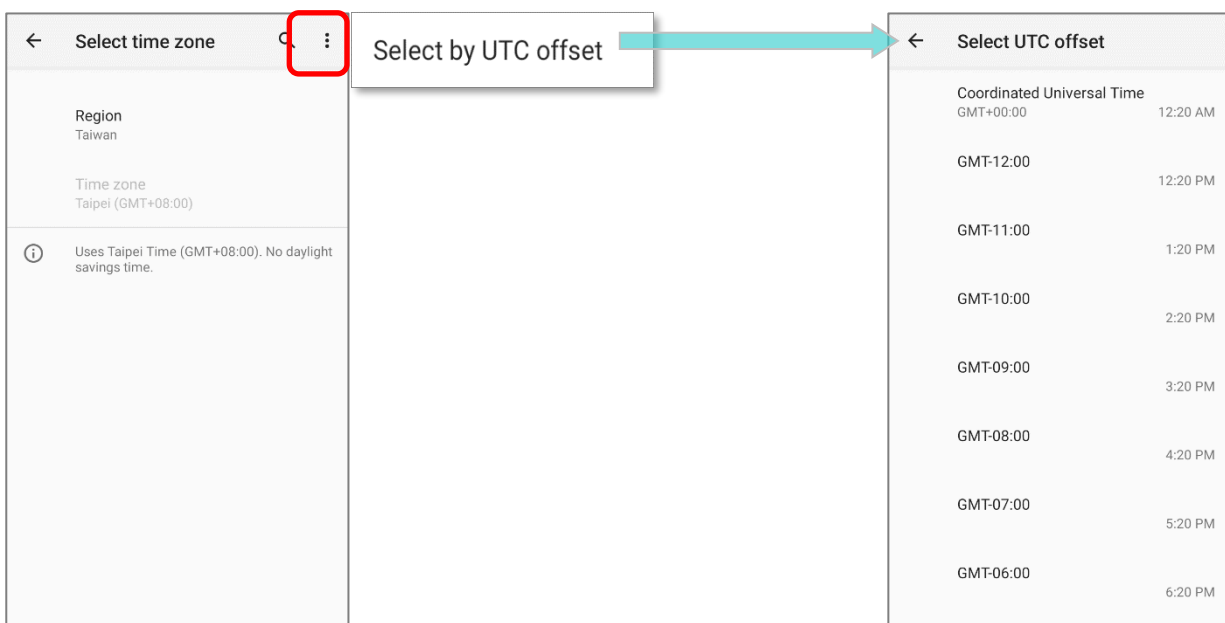
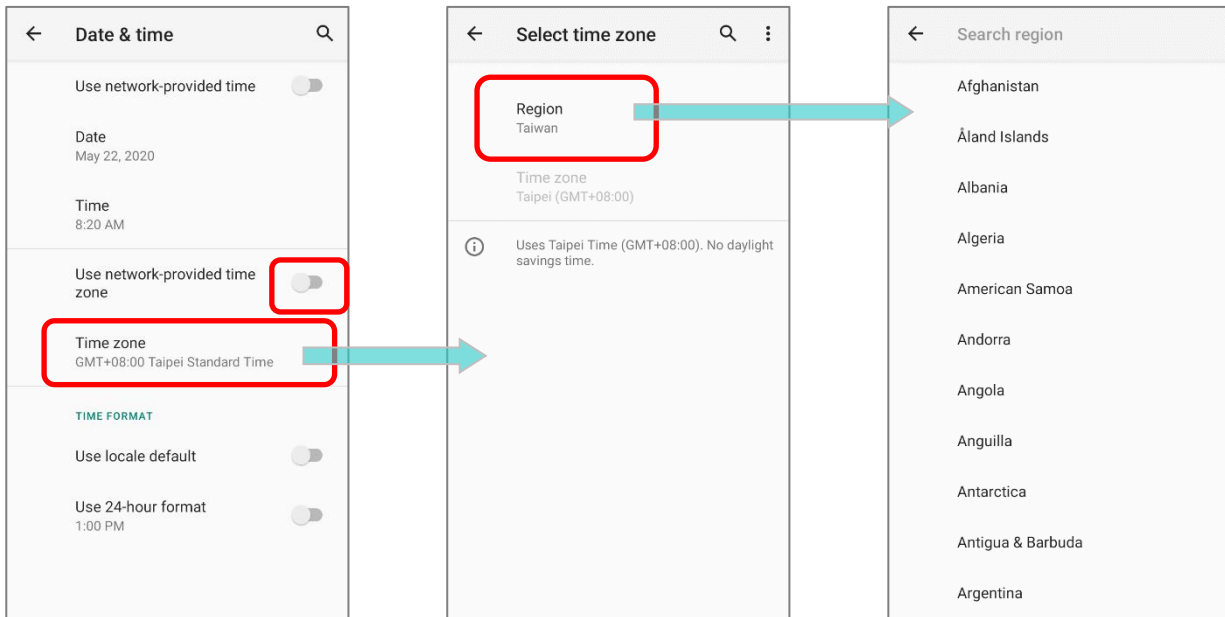

6) Disable **Use locale default** and tap **Use 24-hour format** to switch on or off to change the displayed time.

2.6. LANGUAGE & KEYBOARD INPUT

Tap **App Drawer (All Apps)** | **Settings**  | **System**  | **Language & input**  to change the system language, default keyboard type, and configure keyboard input and speech settings.

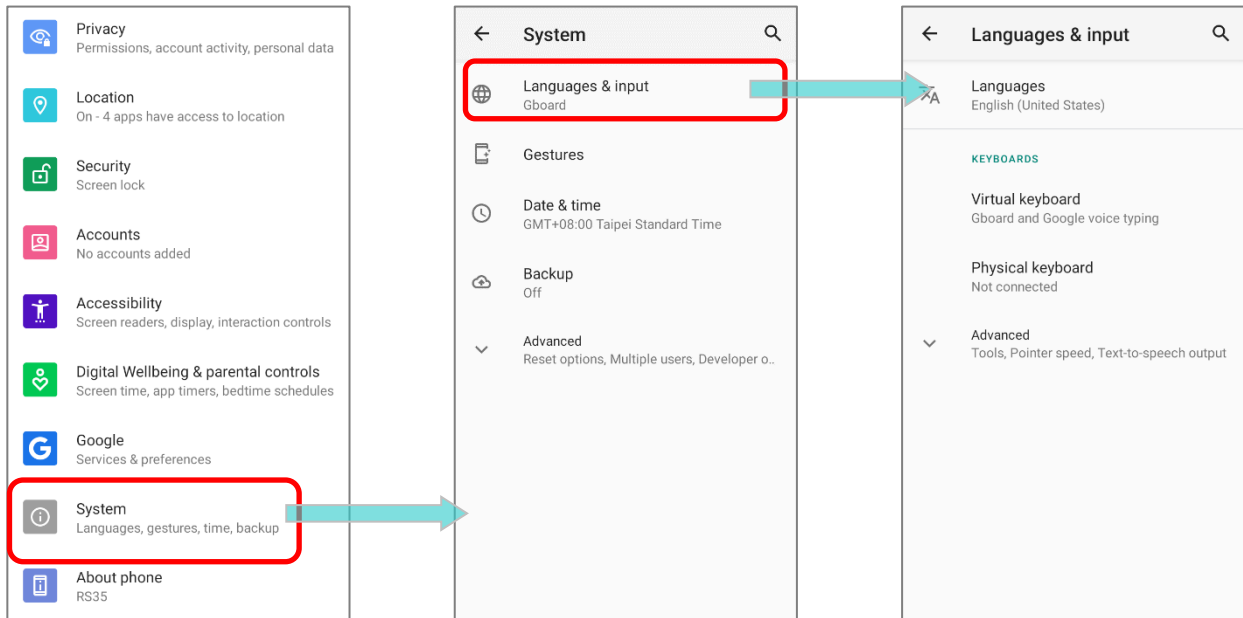

2.6.1. CHANGE DISPLAY LANGUAGE

To change display language:

- 1) On **Language & input** screen, tap on **Language** to get into “**Language preference**” page, and then click “**Add a language**” to select your desired system language.

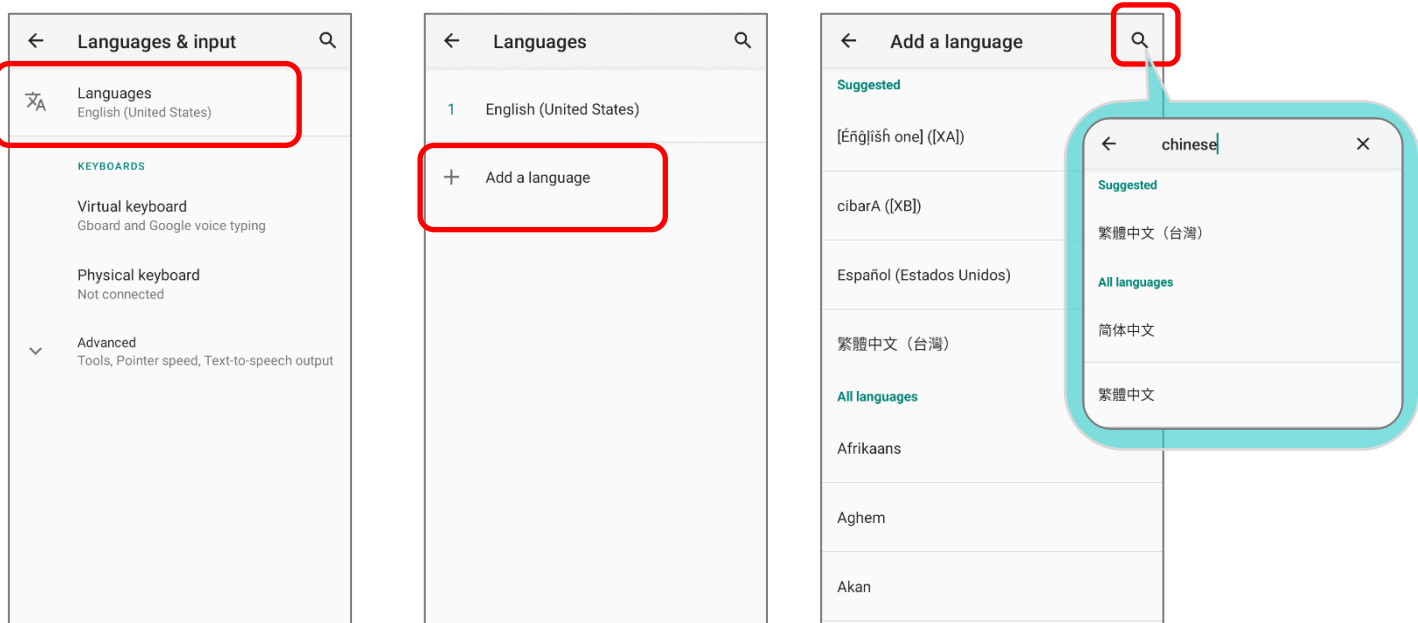

2) Press and hold your desired system language to change its sorting order to the 1st by dragging. Once it is released, the new language setting will immediately be applied.



DELETE LANGUAGE

Tap  in the upper right corner and tap **“Remove”** option; select the language to delete. Please note that the display language will be changed if it is selected to be deleted.

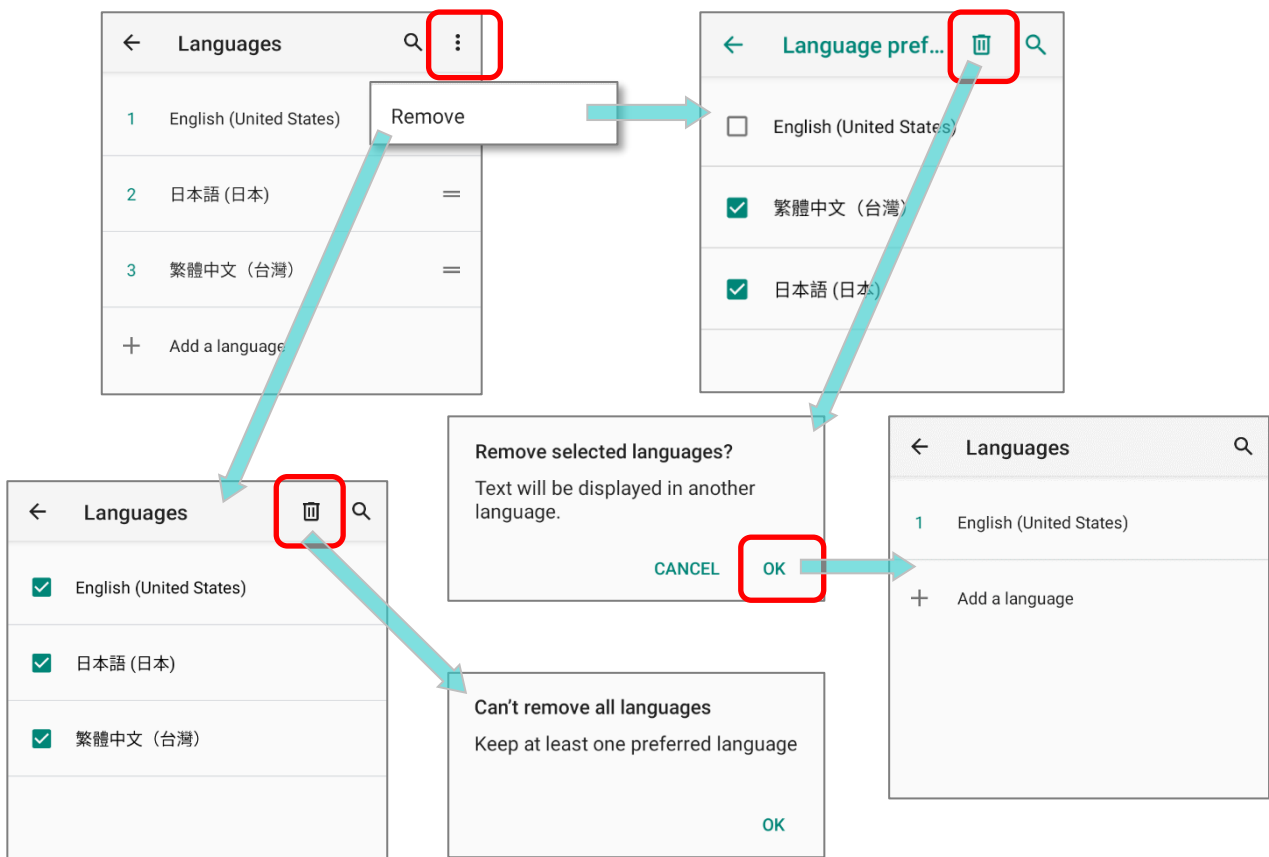

2.6.2. ON-SCREEN KEYBOARD

Tap a text input field to automatically open an on-screen keyboard. The virtual keyboard will vary depending on the data type (text or numbers) this field requires.

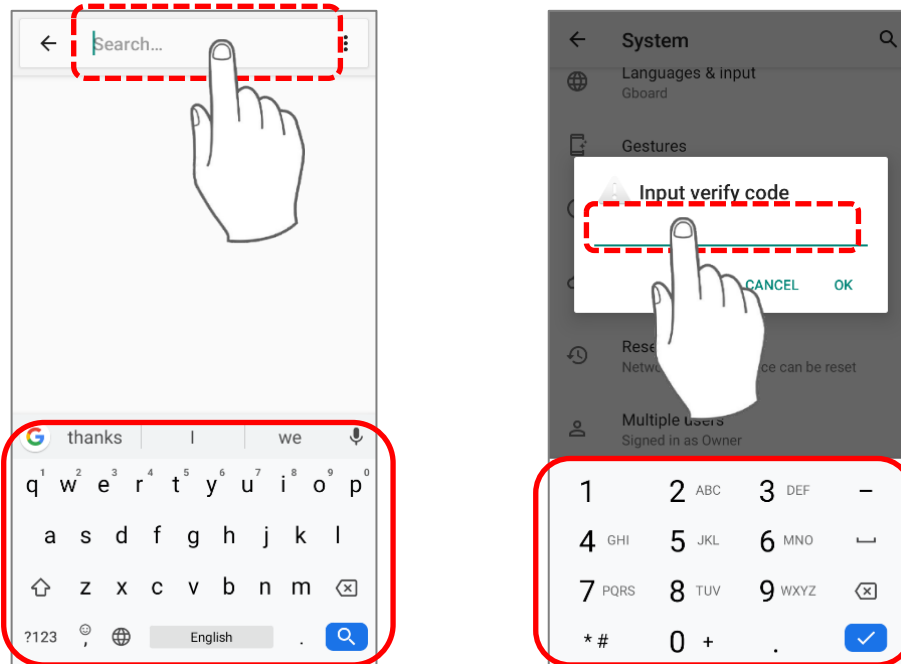

SELECT KEYBOARD (INPUT METHOD)

On **Language & input** screen, select **Virtual Keyboard** to manage the installed keyboards by tapping **“Manage keyboard”** and switch on/off the input methods you need.

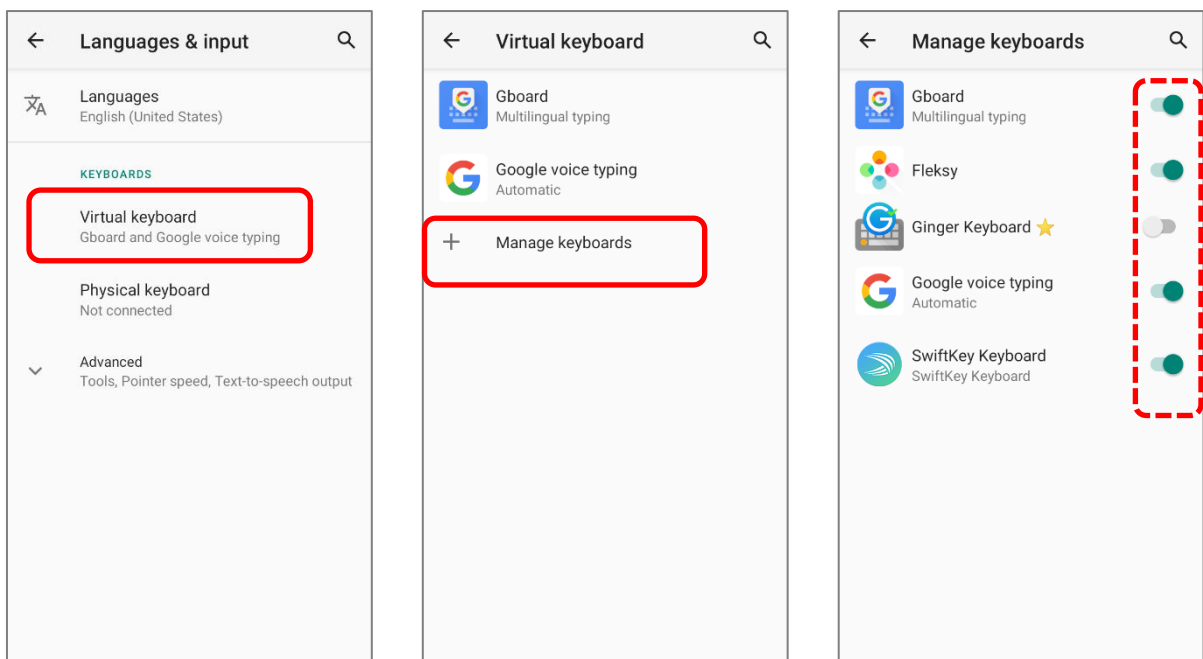

EDIT TEXT

Tap and hold text on the screen to enable a text editing menu for selecting all text, or copying and pasting text within or across applications. Some applications may use different ways to select or edit text.

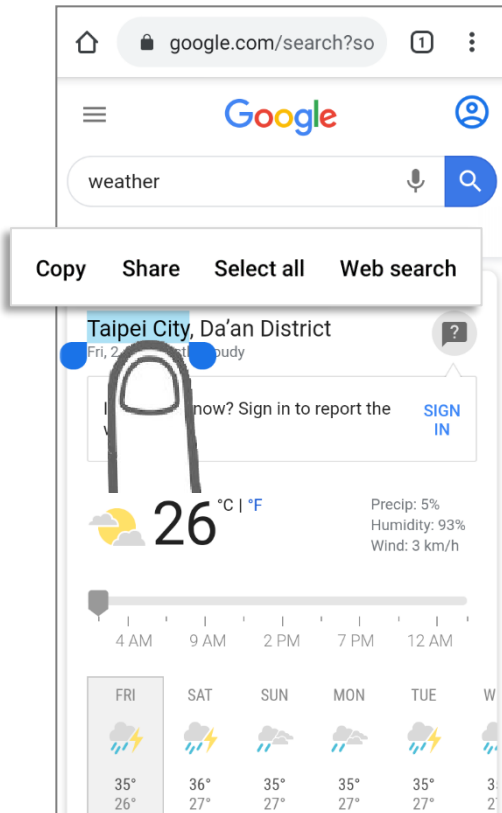

2.7. ENTERPRISE SETTINGS

The default application “**Enterprise Settings**” is to set “**Doze Mode**” of RS35 mobile computer.

DOZE MODE

“**Doze Mode**” is enabled by default.

Please refer to

<https://developer.android.com/training/monitoring-device-state/doze-standby> for details.

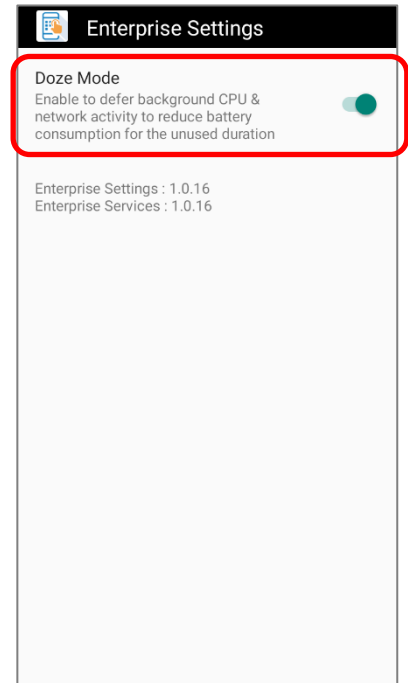

VERSION

The version information about **Enterprise Settings** is listed right below “**Doze Mode**”.

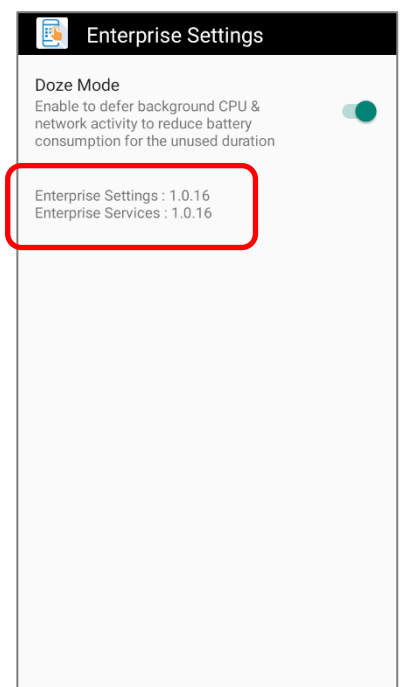

2.8. SOUND AND VOLUME

Use the volume buttons on the left side of the mobile computer to adjust system and ringer volume.

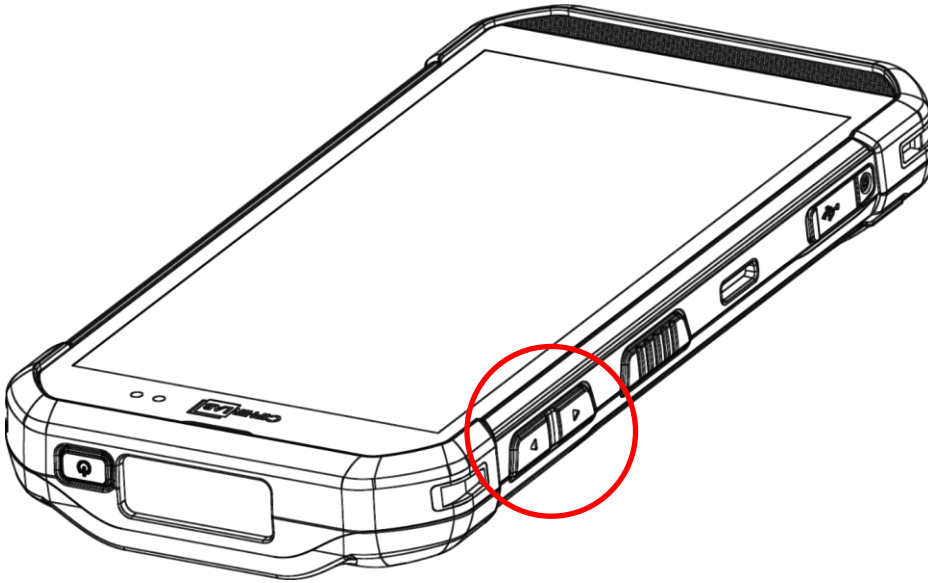

2.9. DATA CAPTURE

2.9.1. BARCODE READER

A selection of scan engines is available for delivering flexibility to meet different requirements. Depending on the scan engine integrated, the mobile computer is capable of scanning barcodes of a number of symbologies that are enabled by default while running the ReaderConfig application. You won't be able to scan a specific barcode symbology which is not enabled. Run ReaderConfig.exe to enable/disable barcode symbologies.

2.9.2. DIGITAL CAMERA

An integrated autofocus 13 megapixels rear camera with LED flash in the mobile computer is specifically designed for collecting image data. You may use the image capture utility to turn on the camera and capture images. By default, the images taken by this camera application are saved as JPG files in the **DCIM** folder in the device's primary storage.

BASIC OPERATION

This chapter describes the basic skills to work with the RS35 mobile computer, for instance how to operate the home screen, check system status and manage notifications. The add-on utilities for applications regarding data collection, processing, and transmission are introduced in the following chapters.

IN THIS CHAPTER

3.1 Home Screen	93
3.2 Navigation Method	97
3.3 Status Bar	101
3.4 Suspend & Lock	109
3.5 OS Update	112
3.6 Back up Your Data	115
3.7 Reset to Factory Default	117

3.1. HOME SCREEN

When the mobile computer is fully charged, press the Power key for three seconds to turn on the mobile computer. A locked screen will appear.

LOCK SCREEN

To enter the **Home** screen, you need to unlock the Lock screen.

Simply swipe up from the bottom toward the unlock icon  to unlock the screen. You may need to further draw the pattern, input PIN or password depends on the [screen lock](#) you set.

APP DRAWER

To open **App Drawer**, please long-swipe up from the bottom of the screen.

CHANGE HOME SCREEN WALLPAPER

- 1) Tap and hold any empty spot on the home screen.
- 2) Tap **Wallpapers** in the menu that appears, and select the app you would like to use.
- 3) Select an image to apply as the wallpaper.
- 4) Tap **Set wallpaper**.

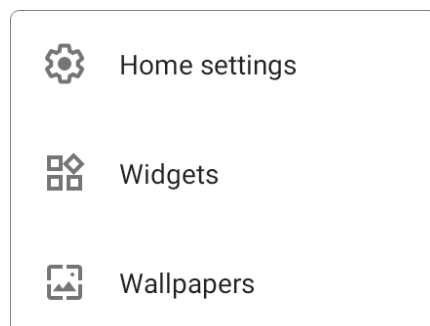

3.1.1. APPLICATION & WIDGET ON HOME SCREEN

ADD APPLICATION SHORTCUT TO HOME SCREEN

To add an application to Home screen:

- 1) Open [App Drawer \(All Application\)](#) on the home screen you would like to customize.
- 2) Locate the application to add, tap and hold the application icon.
- 3) Drag the application icon upward and the home screen will appear. Keep dragging the app icon and move it to your preferred position and release to have it placed.

Long pressing certain applications such as Chrome or Gmail may show the **app shortcuts**. To add such applications from [App Drawer](#) to **Home** screen, please:

- 1) Keep tapping and holding the application icon and drag it upward.
- 2) The **Home** screen will appear. Drag the application icon to your preferred position and release to have it placed.

ADD WIDGET TO HOME SCREEN

- 1) Tap and hold any empty spot on the home screen, and select "**Widgets**" from the appeared menu.

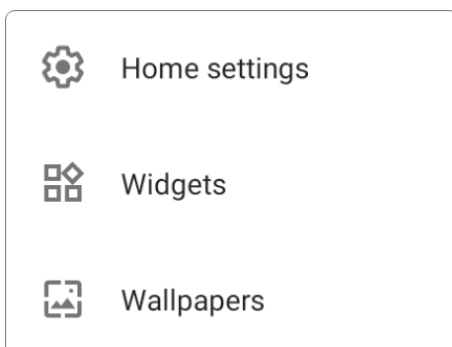

- 2) In the widget selection list, scroll to locate your desired widget.
- 3) Tap and hold the widget until the home screen layout appears. Drag the widget to your preferred position and release to have it placed.
- 4) For a setting shortcut, you will have to select a specific setting from the shortcuts list.

ADD AN ACTION ICON FROM APP SHORTCUT TO HOME SCREEN

To create an **Action** icon from the **app shortcuts** to Home screen, please:

- 1) Long press an application icon (no matter on the **Home** screen or the [App Drawer](#)) to unfold its **app shortcuts**.
- 2) Tap and hold an **Action** from the **app shortcuts** and drag it to the preferred position on the Home screen.
- 3) Release the **Action** icon to have it placed.

ARRANGE THE APPLICATIONS AND WIDGETS ON HOME SCREEN

To move or remove a shortcut/widget, on the home screen you would like to customize, tap and hold it, and then drag it to anywhere on Home screen to enter layout edit mode. An option "**X Remove**" will appear on top of the screen where you can drag the unwanted shortcut/widget to remove it. Drag the icon to the preferred position and release it to have it placed, or drag it to "**X Remove**" to remove it.

To resize a widget, tap and hold it until a white frame appears. Tap and drag a white dot to re-scale the widget.

ARRANGE THE APPLICATIONS WITH APP SHORTCUTS ON HOME SCREEN

To move or remove those applications which offer app shortcuts, please hold and drag the application icon to anywhere on the screen, and the layout edit mode appears. Drag the application icon to "**X Remove**" on the top of the screen to remove it, or to the preferred position and release it to have it placed.

3.1.2. FOLDER ON HOME SCREEN

CREATE FOLDER

- 1) On the home screen you would like to customize, tap and hold the application shortcut you would like to move, drag the icon on the top of another icon to create a folder.
- 2) As these icons overlap, a folder is created.
- 3) After you let go your finger, these icons are enclosed in a square.

NAME A FOLDER

- 1) Tap the folder you would like to name.
- 2) The folder will expand from a small square to a full rectangle to show all the shortcuts in it. Tap "**Unnamed Folder**" and edit the folder name.
- 3) Tap **Done** button on the on-screen keyboard.
- 4) Tap elsewhere on the screen, the folder will shrink to a small square with its new name.

REMOVE FOLDER

- 1) Tap and hold the folder you would like to remove.
- 2) Drag the folder to the top of the screen where the option "**X Remove**" is located.

Note:

Please note when you remove a folder, the shortcuts contained in it will be removed as well.

3.2. NAVIGATION METHOD

Navigation is to control the device by using swipes and other actions or tapping on buttons.

3.2.1. CHANGE THE NAVIGATION METHOD

The default navigation method is 3-button navigation which appears as the menu bar on the bottom of the screen. To change your navigation method, please go to [App Drawer](#)

[\(All Apps\)](#) | **Settings**  | **System**  | **Gesture**  | **System navigation**

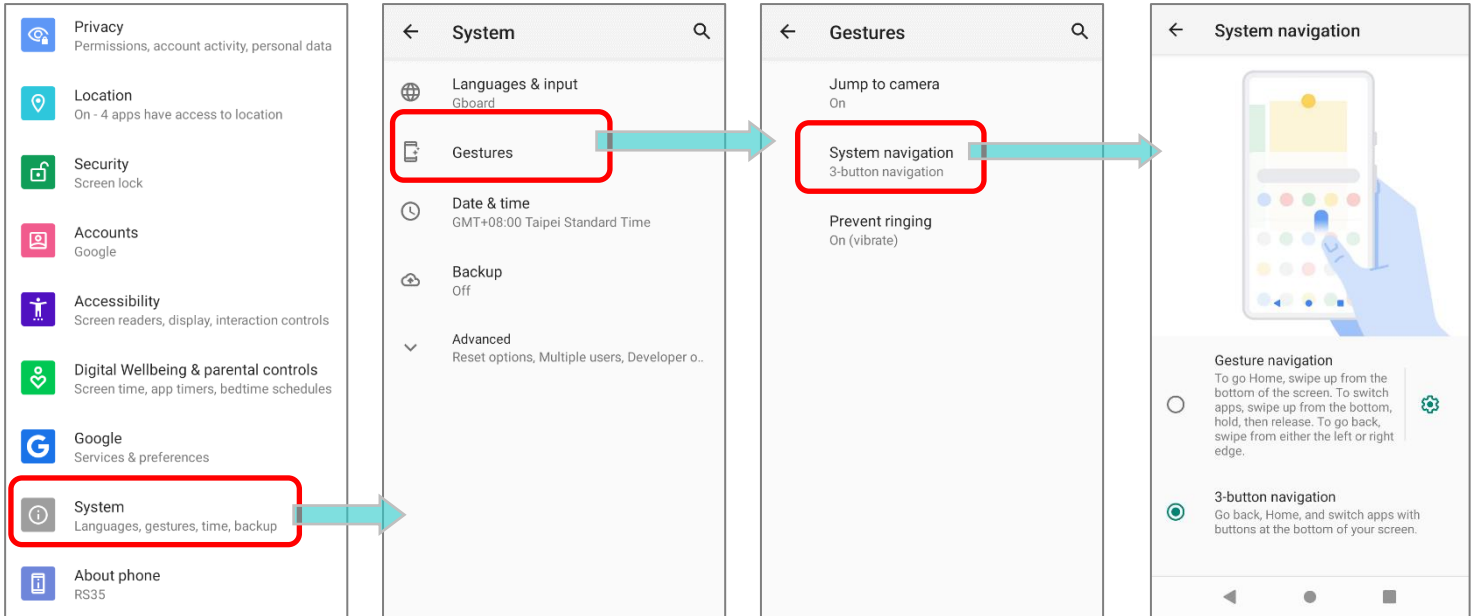

The available options are:

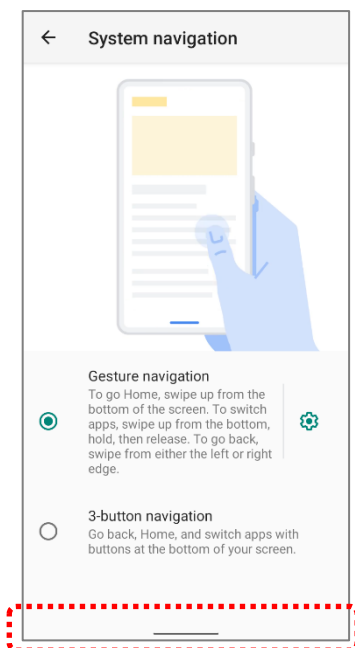

Gesture navigation

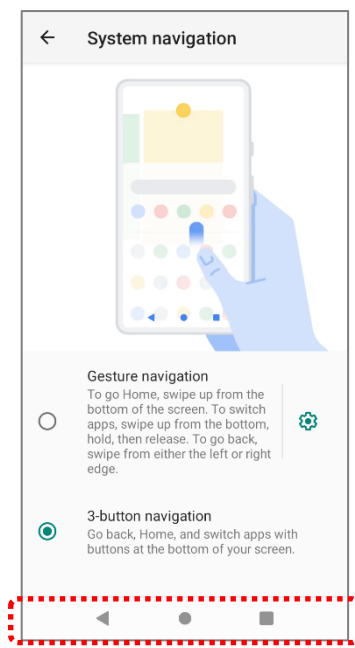

3-button navigation (default)

GESTURE NAVIGATION

“**Gesture navigation**” is for navigating through the screens and menus by gesture-based controls. Once is enabled, you can control the device screen by following the gestures:

Action	Gesture
Home	Quickly swipe up from the bottom of the screen.
Back	Swipe either on the left or the right edge of the screen.
Recently Used Apps	Swipe up from the bottom of the screen and then stop for few second before releasing your finger.
Google Assistant	Swipe up from one of the bottom corners toward the middle of the screen, and then pause for a while.
App Menus	Swipe on the screen from the left side or the right side with two fingers.

Tap on the setting button  will open “**Back Sensitivity**” popup which allow you to set the distance of the inward swipe from the screen side edge to trigger “**Back**” gesture. The higher sensitivity you choose, the farther distance from the screen edge you have to go to.

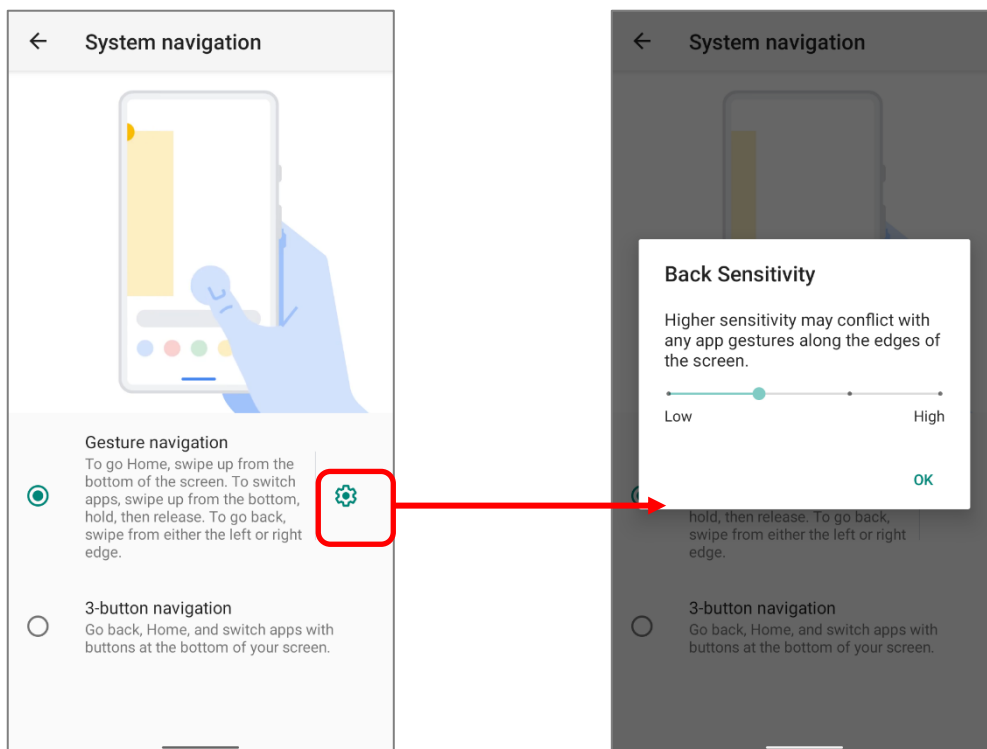

3-BUTTON NAVIGATION

3-button navigation is the default navigation method which displays **Home**, **Back**, and **Recently Used Apps**.

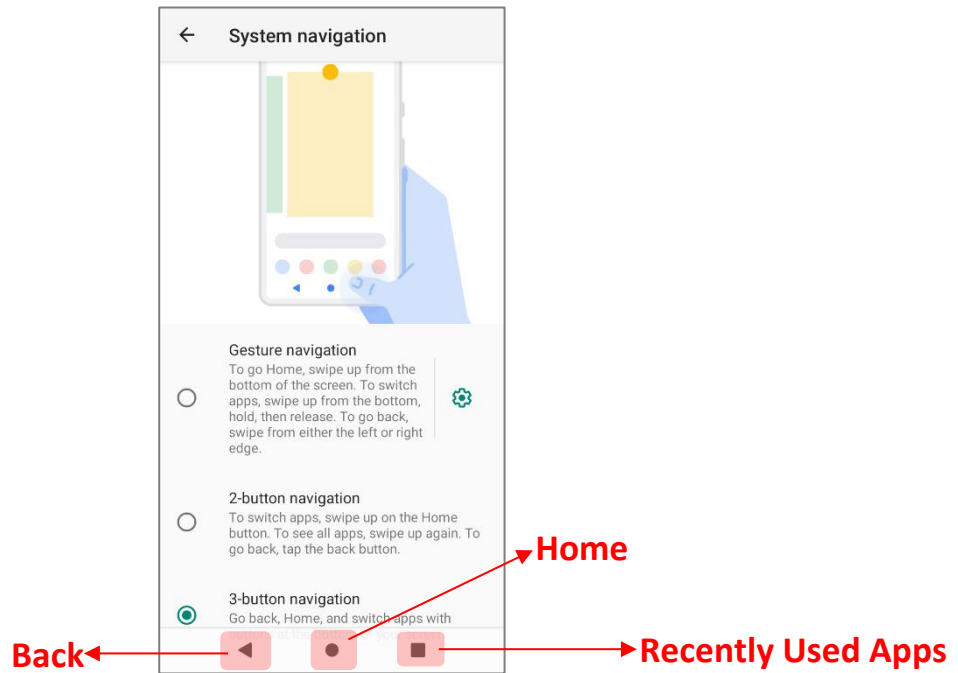

3.2.2. RECENTLY USED APPLICATIONS

To reveal the **Recently Used Apps Menu**, you can:

▶ For **“Gesture navigation”**:

Swipe up from the bottom of the screen and then stop for few second before releasing your finger.

▶ For **“3-button navigation”**:

Directly tap on **“Recently Used Apps”** button.

On this screen, you can:

SWITCH BETWEEN APPLICATIONS

Slide to the left or right to check the listed applications, tap on your desired one to open it on the screen.

END APPLICATION

Swipe an application up to close it.

Note:









Close unused applications in order to release RAM. Remember to save your data or settings before closing any application.

3.3. STATUS BAR











The left side of the status bar shows **notification icons**, and the right side of the status bar shows **status icons**.

3.3.1. ICONS ON STATUS BAR

STATUS ICONS

Icon	Description
	The device has been connected to a Bluetooth device.
	The device is currently connected to a Wi-Fi network and performing data transmission.
	Airplane mode is active, which means all radios are inactive now.
	Alarm is active.
	All sounds are silent except for alarms (Vibration mode).
	The main battery is fully charged.
	The main battery is partially drained.
	Main battery level is very low and needs charging immediately (<15%).
	External power source is connected and main battery is being charged.

NOTIFICATION ICONS



Icon	Description
	Android System notification such as " USB debugging connected " or " USB file transfer turned on ". Open Notifications Drawer for more details.
	The device is performing data synchronization.
	There is an upcoming event.
	The device is downloading data. / Download completed.
	The device is uploading data. / Upload completed.
	An open Wi-Fi network is available.
	A memory card has been inserted.
	The headset has been inserted.
	Wi-Fi hotspot is active.
	Wi-Fi will turn on automatically when there's the saved network with a strong signal nearby.

3.3.2. OPEN QUICK SETTING MENU

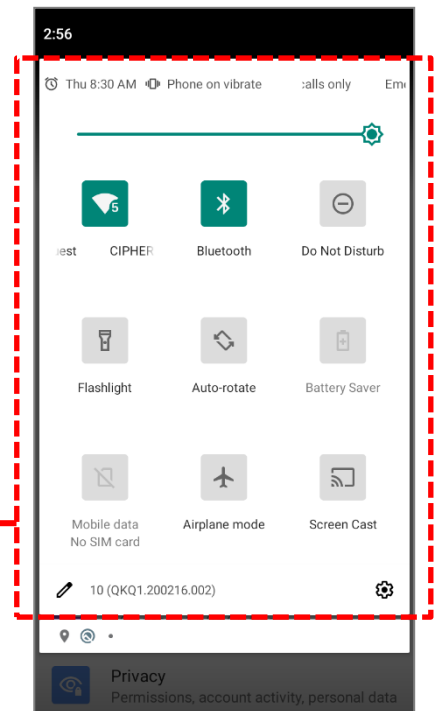
The **status icons** are related to essential settings regarding the device’s remaining power, Bluetooth status or Wi-Fi connectivity status. The status bar offers a quick access for you to easily make adjustments of the settings. To open **Quick Setting Menu**, please swipe from the top to the bottom of the screen. You can tap on each status icon on the menu to switch among different modes or enter the settings.



Quick Setting Menu ←

Tap on the two buttons,  and , on the bottom side of the **Quick Setting Menu** will respectively enter the below pages:

 **Quick Setting Menu Edit Page**

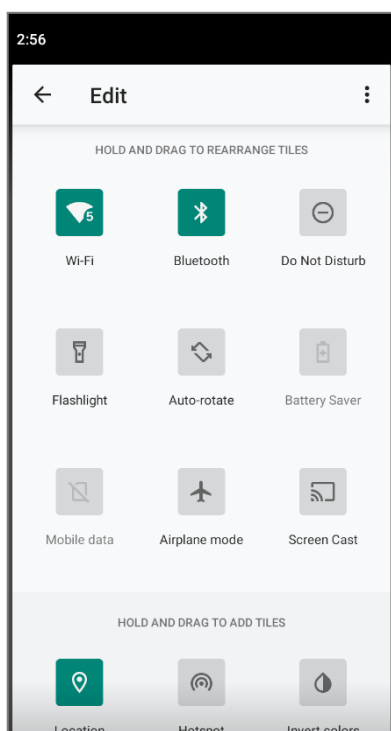

 **“Settings” Page**

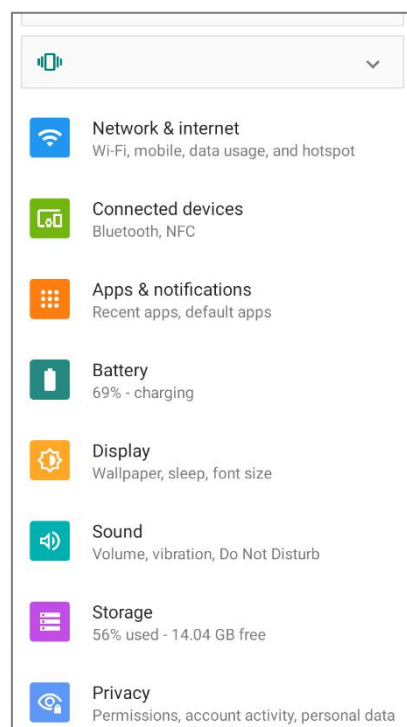



EDIT QUICK SETTING MENU

To customize **Quick Setting Menu**, please:

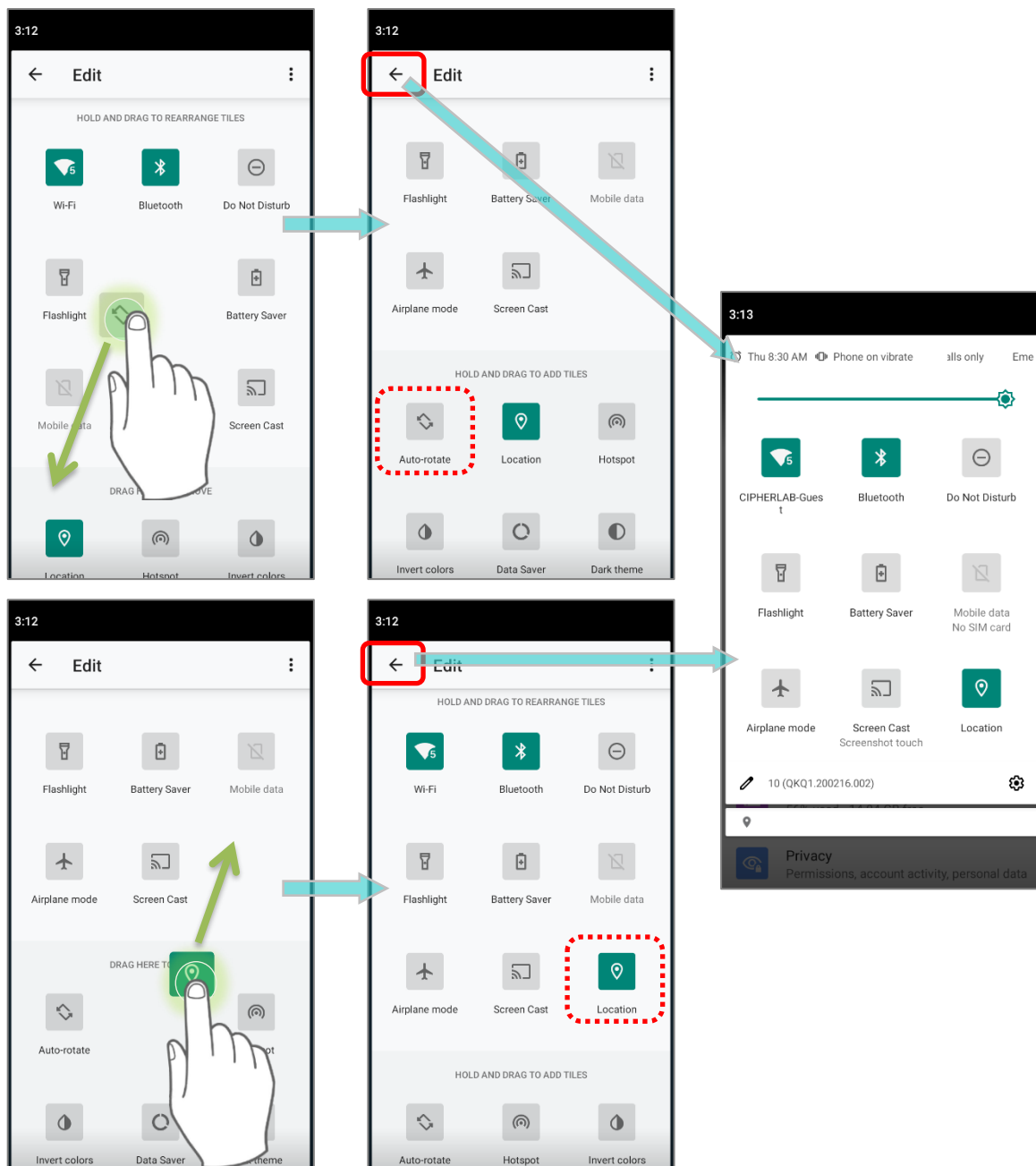
- 1) Click "**EDIT**"  to get into **Edit** page.
- 2) **Remove**: To remove certain item, please tap on and hold the icon to be removed, and drag it to the "**DRAG HERE TO REMOVE**" area and then release it.
- 3) **Add**: To add certain item, please tap on and hold the icon to be added and drag it to the upper area and then release it.
- 4) Return to the **Quick Settings Menu**, all the settings are done.



To reset the **Quick Setting Menu**, please:

- 1) Tap **"EDIT"**  to enter **Edit** page.
- 2) Tap **More** icon  in the upper-right corner, and tap **"Reset"**.

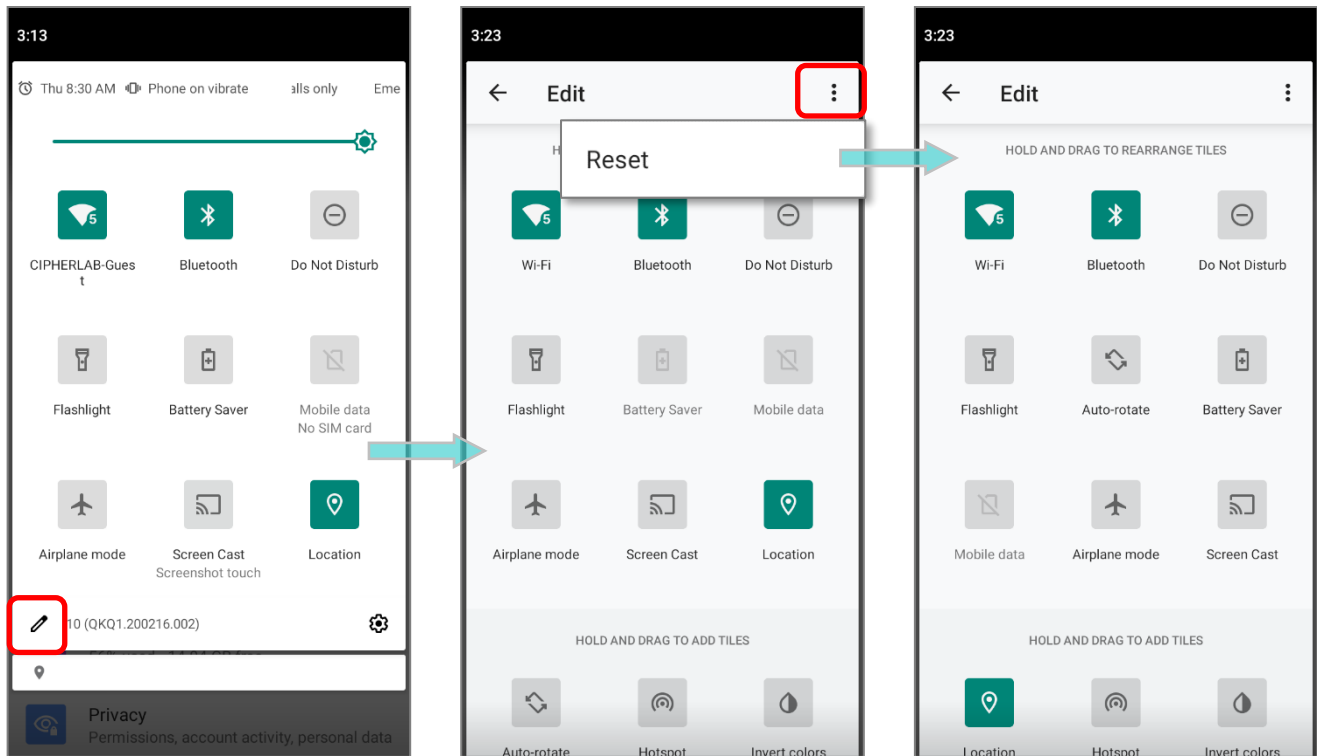

3.3.3. OPEN NOTIFICATIONS DRAWER

The **notifications icons** on status bar inform you of the new events such as incoming calls, messages or USB connection.

CHECK OUT NOTIFICATION

To check out details of the events, swipe down from the status bar to open [Notifications Drawer](#). Tap on the individual notification card to carry out immediate action or to open the corresponding application.

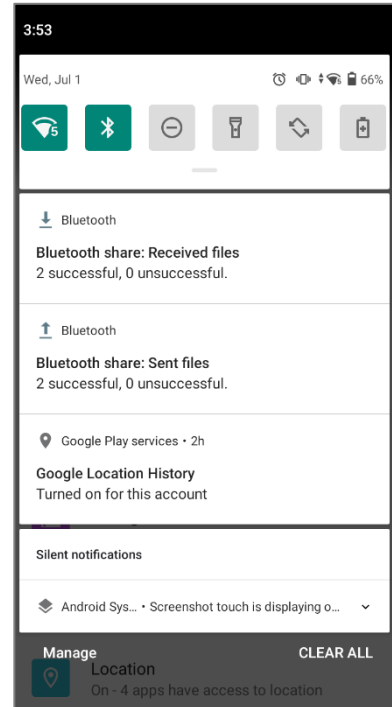

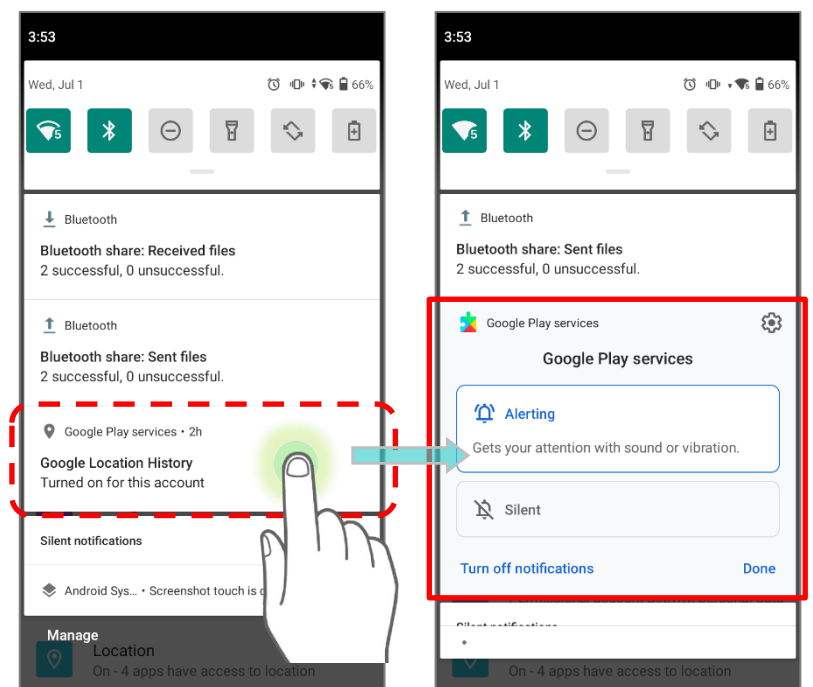

DISABLE NOTIFICATION

You can turn off the notification of a specific app by tapping and holding on the notifications card until the corresponding app name reveals. Tap to choose **"Alerting"**, **"Silent"**, or **"Turn off notifications"**.



OR

- 1) Go to [App Drawer \(All Apps\)](#) | **Settings**  | **Apps & notifications**  | **See all XX apps** to find the app you would like to change its notification settings.

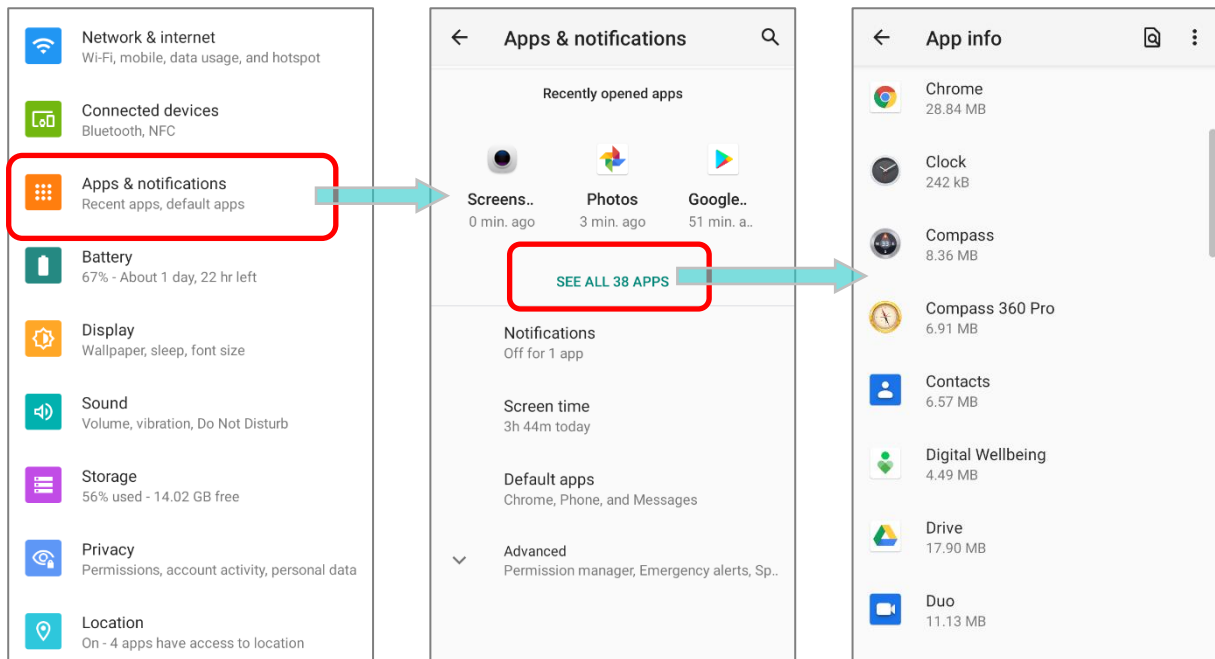

- 2) Tap to enter the "App info" page and tap "Notifications" to switch on or off "Show notifications" and other settings.

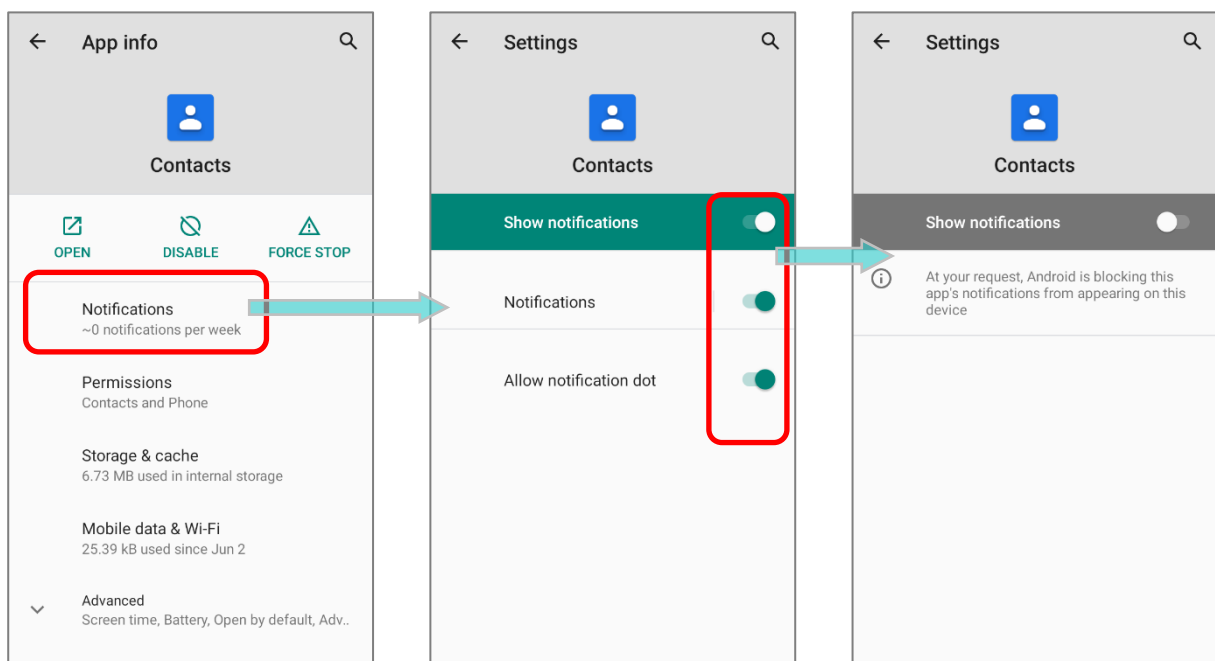

CLEAR NOTIFICATION

To dismiss all notifications at a time, please tap on “**CLEAR ALL**”. Ongoing notifications and notifications that require subsequent activity to be cleared will remain on the list.

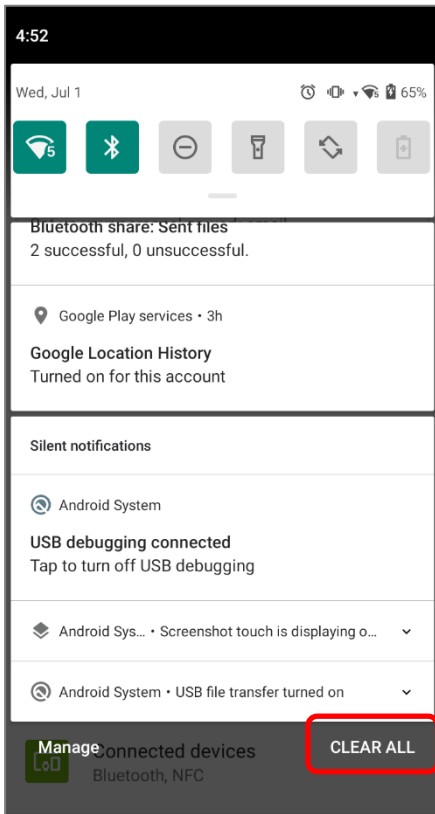

3.4. SUSPEND & LOCK

3.4.1. SUSPEND DEVICE

The mobile computer operates continuously once it is powered on. To minimize power consumption and prevent unintended operation, suspend the mobile computer if you are not actively using it. The mobile computer can be quickly awoken from suspend mode to operate as needed. When the mobile computer enters suspend mode, the system is in a power-saving status, meaning the device will not respond to screen touch, and volume keys and side buttons will also be unavailable until the device is unlocked.

SUSPEND RS35

Press the power button to suspend the mobile computer. The mobile computer will automatically suspend when the time period set in [Screen Timeout Settings](#) has passed without any activity.

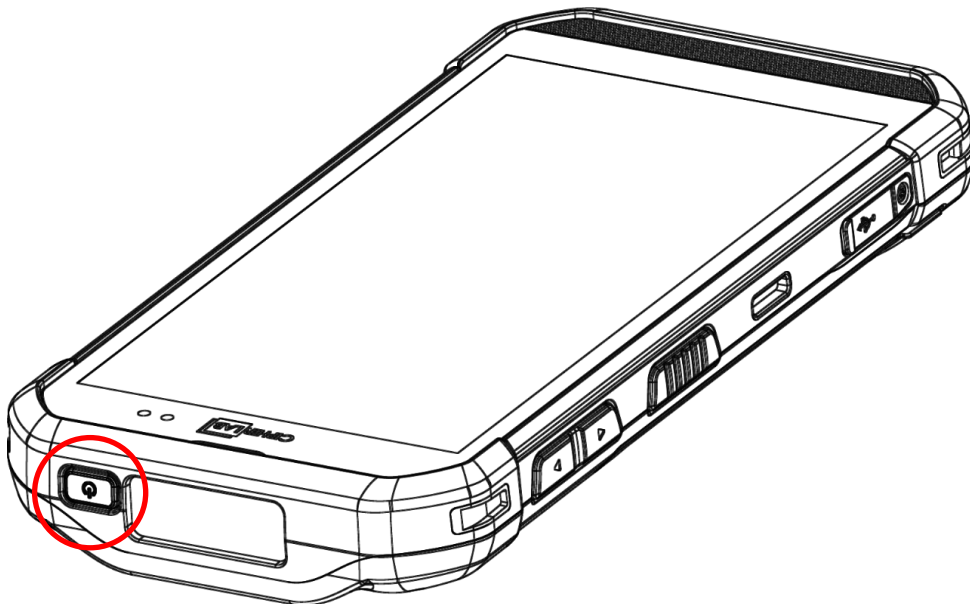

Power Button

3.4.2. LOCK DEVICE

Setting a screen lock allows you to protect your personal data on this device while the device is not at your hand. With various types of screen lock available and Smart Lock, you can not only enjoy the benefits of this function but also great convenience.

LOCK RS35

Go to [App Drawer \(All Apps\)](#) | **Settings**  | **Security**  | **Screen lock** to change the lock method.

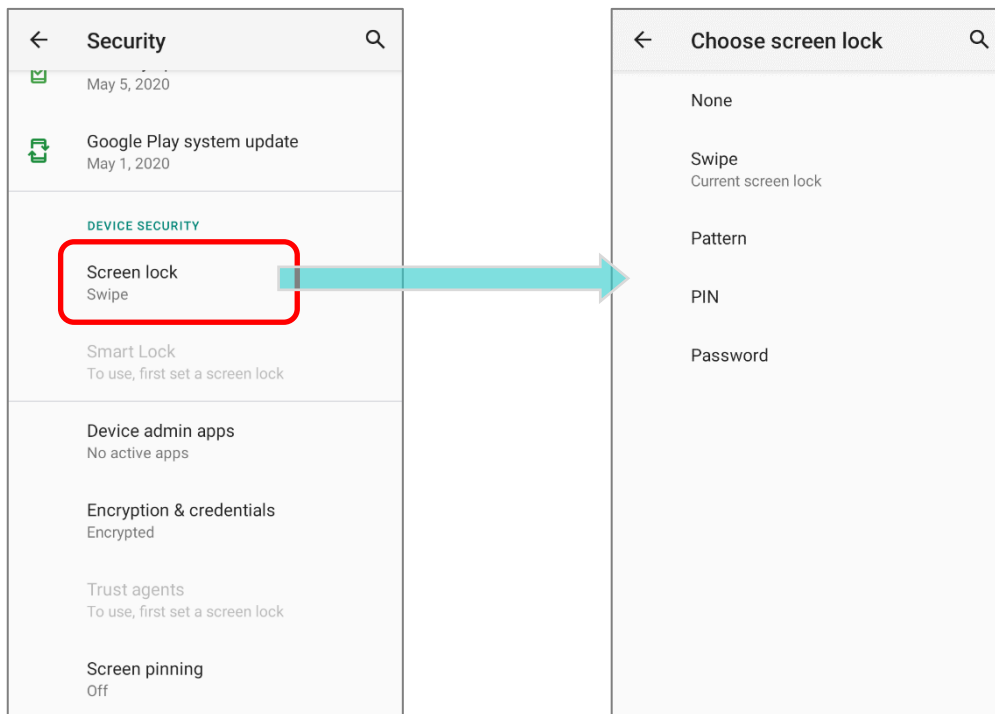

Item	Description
None	Disable screen lock.
Swipe	Default slide gesture.
Pattern	Enter a pattern to unlock.
PIN	Uses the PIN code to unlock.
Password	Enter a password of at least 4 characters to unlock.

By selecting a **Pattern**, **PIN**, or **Password** method, a setting icon appears next to “**Screen lock**”. Tap to enter “**Screen lock**” page for further configurations.

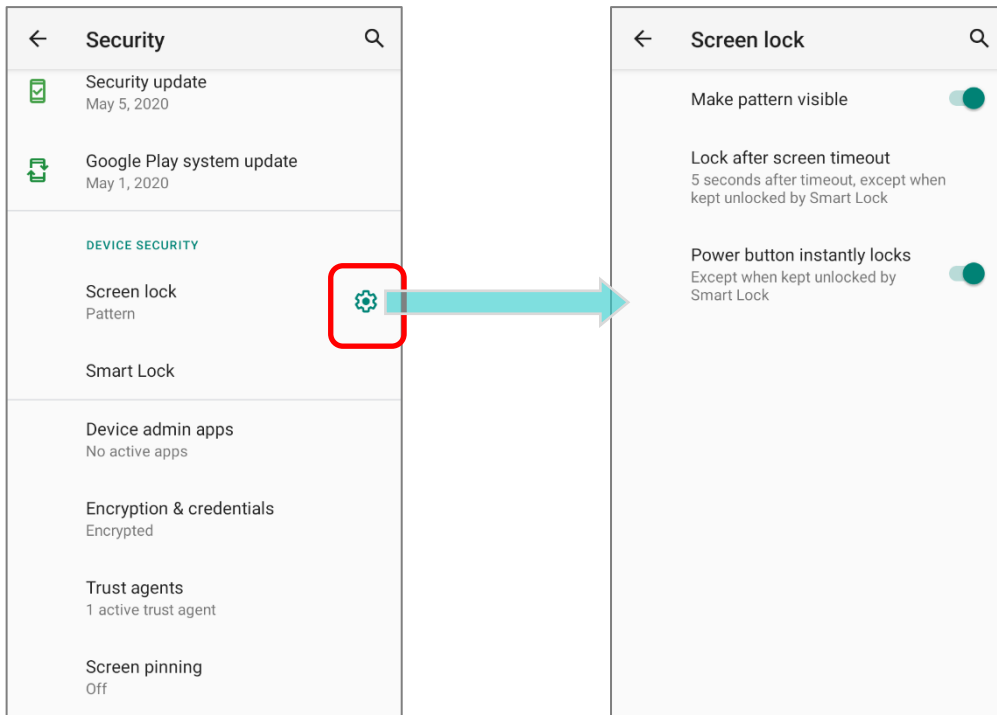

You can also access advanced settings and **Smart Lock** to customize personal lock settings.

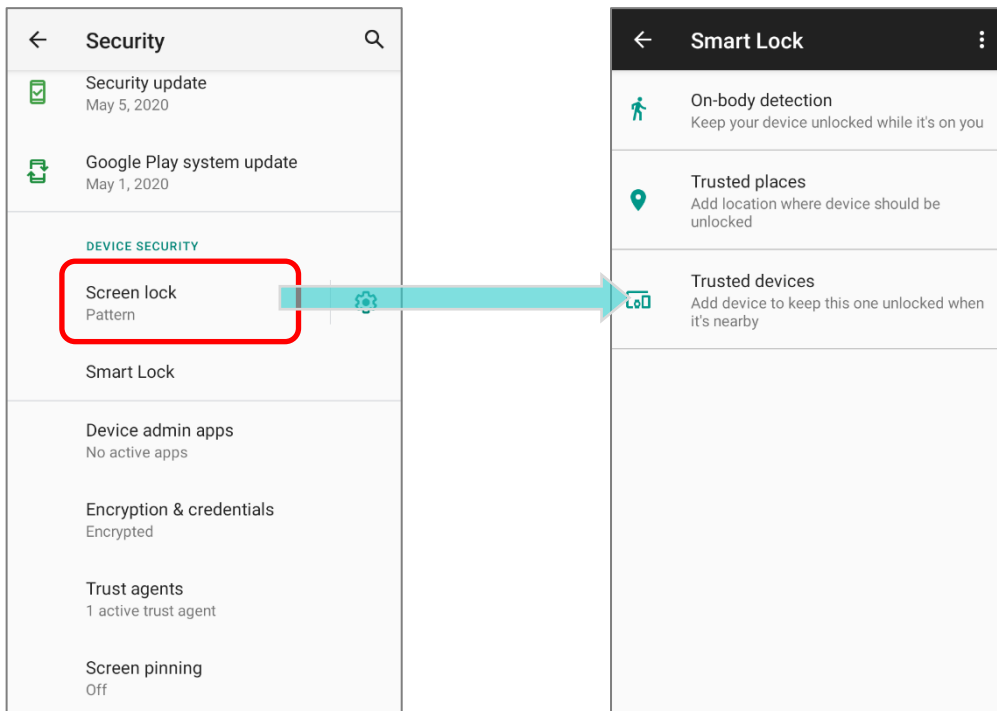

3.5. OS UPDATE

Updating the operating system on the mobile computer helps maintain it at an optimized state. You may choose to update the system by establishing a wireless network connection to the Internet and downloading the update file from the OTA server.

Note: The mobile computer will shut down during system update. Save any unfinished tasks and data before updating the system in order to avoid data loss.

3.5.1. NETWORK UPDATE

In order to check for and download the latest system update file on the server, make sure a wireless network connection to the Internet is established on the mobile computer.

Note: To avoid any additional charges to your wireless data plan, Wi-Fi connection to the Internet is recommended for downloading the file.

- 1) Go to [App Drawer](#) | **Settings**  | **System**  | **Advanced** | **System updates**

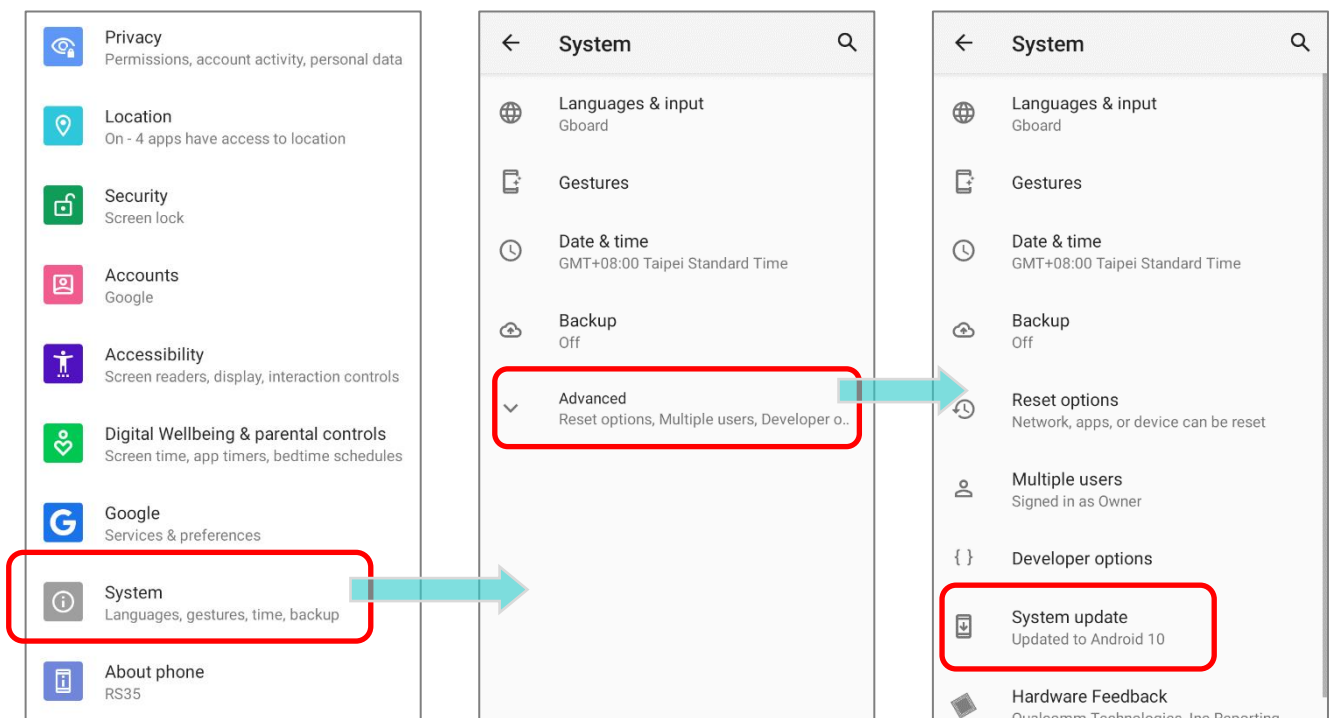

- 2) A window pops up asking you to input the password for system update. Please contact with support@cipherlab.com.tw for the password. Enter the password and tap **OK**.

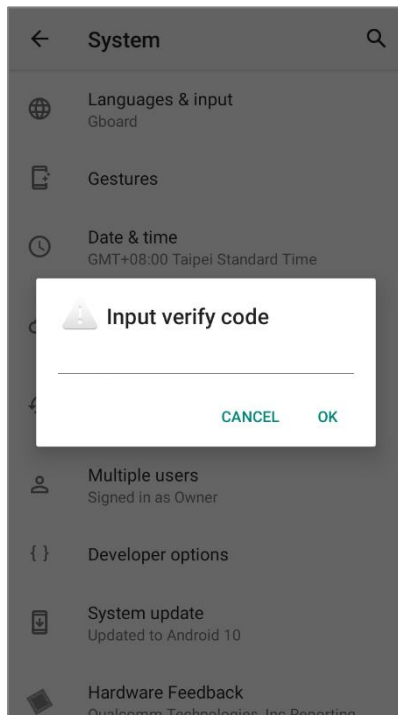

- 3) The mobile computer searches for the latest system update file on the server. Tap **DOWNLOAD AND INSTALL** to download the update file.
- 4) When a new system update file is detected on the server, a notification icon will appear on the status bar, and a text notification will pop up in the notifications panel.

AUTOMATIC UPDATE

The automatic update feature of RS35 mobile computer is off by default, and you can change the setting by **ADC** (Android Deployment Configurator) to turn it on.

By enabling automatic update feature, RS35 mobile computer automatically detects whether there's the latest OS update and downloads it. The update is scheduled to proceed on early morning when the device is on and left idle.

3.5.2. SD CARD UPDATE

RS35 mobile computer automatically searches the available update files in your mobile computer's storage and then install it.

Please obtain the latest system update image file, and copy the file "sdupdate.zip" onto the folder "sdupdate" of your SD card. Insert the SD card into the memory card slot on the device. Press the power button to power it on.

OR

Transfer the update image file to the root directory of the device's internal storage via a USB Type-C cable/ the snap-on cable.

The newest version of OS will be automatically installed and take effect next time the device is booted up.

Note:

Make sure the SD card is properly inserted in the mobile computer; otherwise the system is regarded as currently up to date.

3.6. BACK UP YOUR DATA



With **Backup**, you can have your personal data (Google Calendar settings, Google contacts, Chrome browser data and Gmail settings) and certain system settings under your Google Account backed up (over network connection) on the cloud. This allows you to easily restore the settings on this device after a Factory Reset (refer to [Reset to Factory Default](#)).

To start:

1) Make sure your device is connected with network.

2) Go to [App Drawer](#) | **Settings**  | **Google**  | **Backup**

OR

[App Drawer](#) | **Settings**  | **System**  | **Backup**  and enable **Back up to Google Drive**.

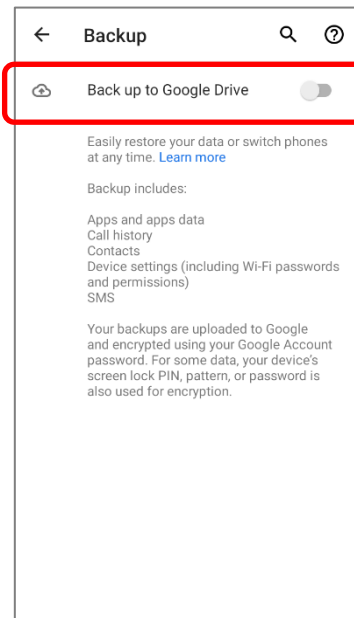

3) Tap **Account** to log in to your Google Account.

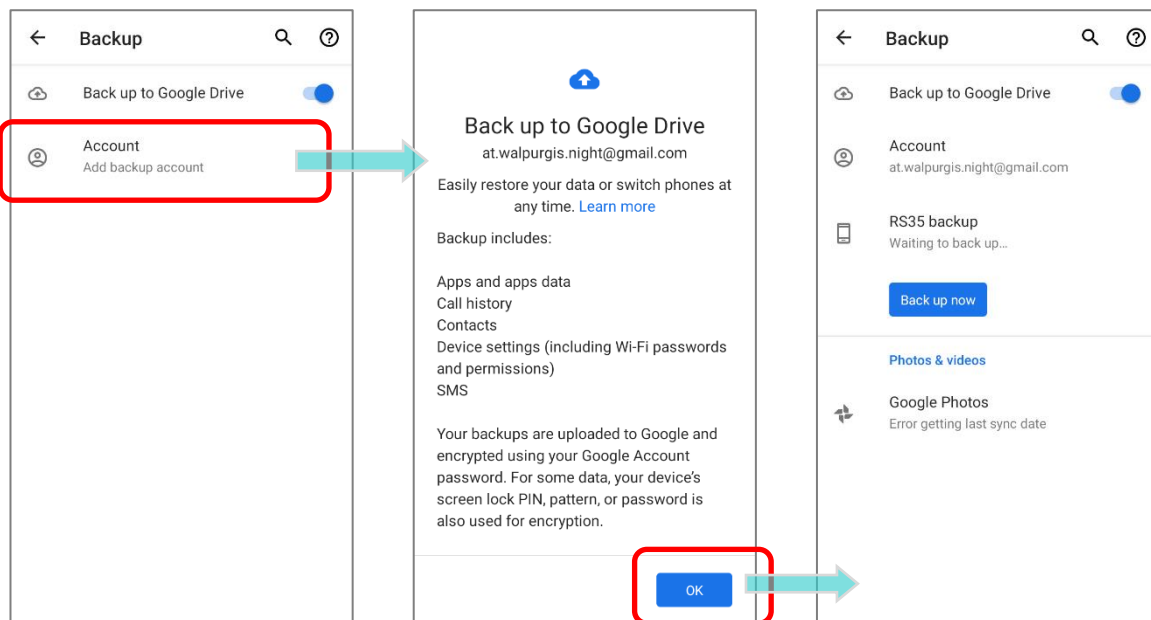

To restore your backed up personal data of a Google Account, just add that account to the device.

Note:

(1) To back up your photos and videos, tap **Photos**  in **App Drawer** and log in your Google Account to sync the files on your device with Google Photo Library.

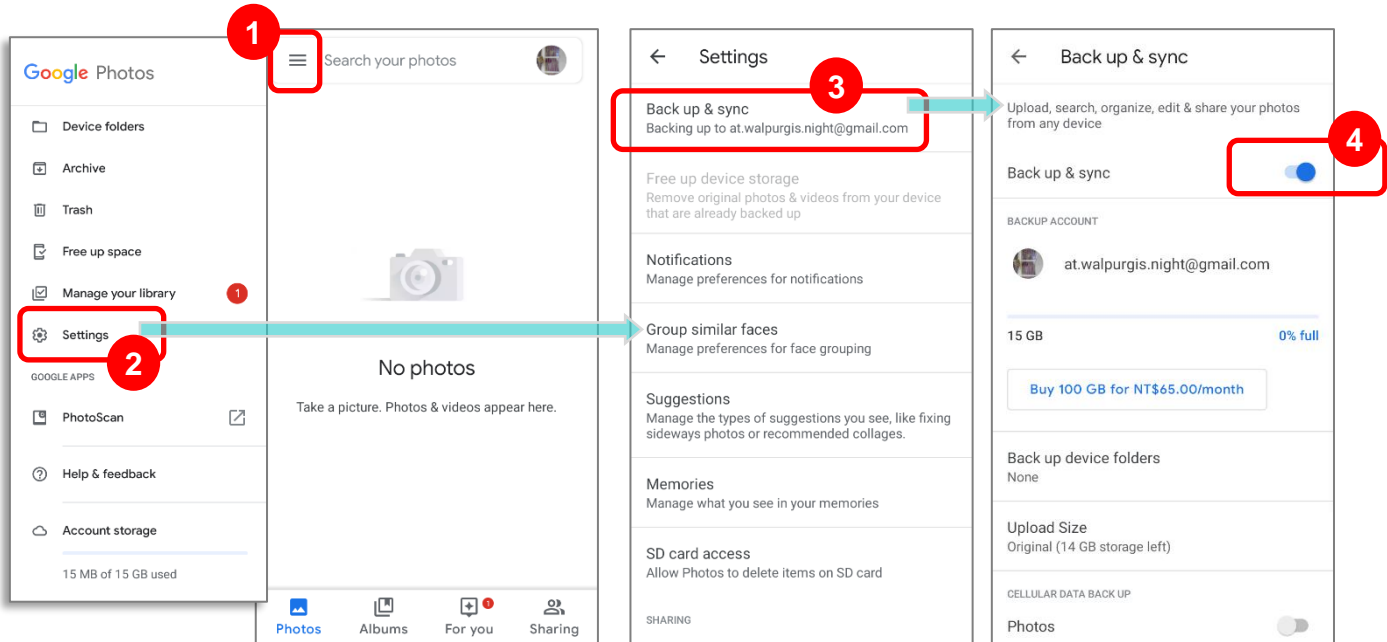

(2) To back up other data such as audio or video files on the device's storage, you can make use of the Google Drive service.

(3) **Backup** may not handle certain app progress data and settings.

3.7. RESET TO FACTORY DEFAULT

Performing a factory reset will erase all data on your mobile computer (including, files as well as your installed apps and their associated data) and revert the device back to its original state in which it is powered on for the first time.

It is strongly recommended that following the instructions in [Back Up Your Data](#) to back up important data before performing a factory reset.

When setting your RS35 mobile computer by **ADC (Android Deployment Configurator)**, the settings will automatically backup to “**enterprise partition**” of your RK95 mobile computer, and the settings saved in enterprise partition will not be erased by proceeding “**Erase all data (factory reset)**”. To erase all the settings, please select “**Erase all data (factory reset with enterprise)**”.

3.7.1. ERASE ALL DATA (FACTORY RESET)

“**Erase all data (factory reset)**” will erase all the data except of the settings backed up in enterprise partition by ADC (Android Deployment Configurator).

To start:

- 1) Go to [App Drawer \(All Apps\)](#) | **Settings**  | **System** 

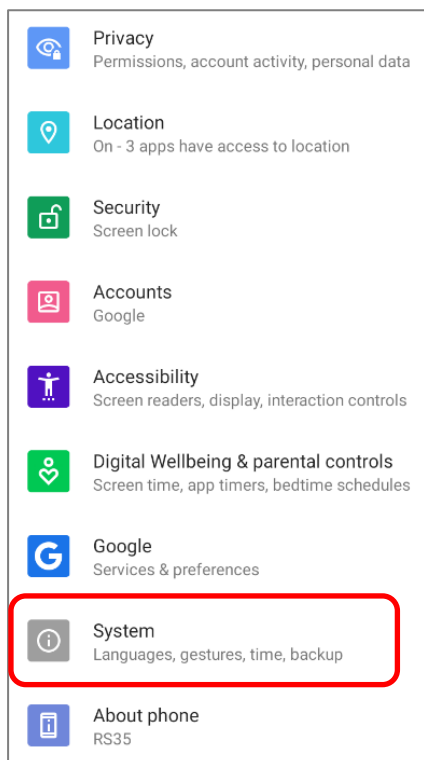

- 2) Tap on “**Advanced**” to expand more functions, and then select **Reset options** and **Erase all data (factory reset)**

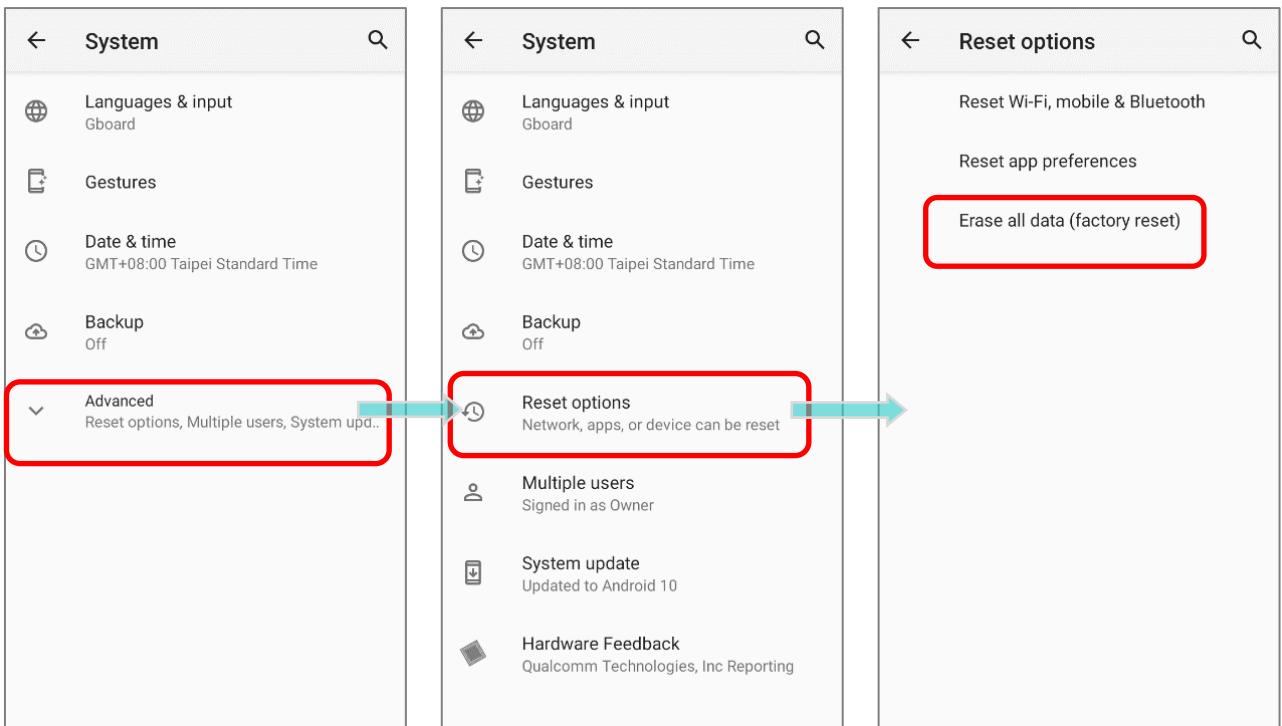

- 3) Confirm the action by tapping on the button “**Erase all data**” and input the verification code (Please contact with support@cipherlab.com.tw to obtain your verification code). Finally, tap **OK** to perform a factory reset.

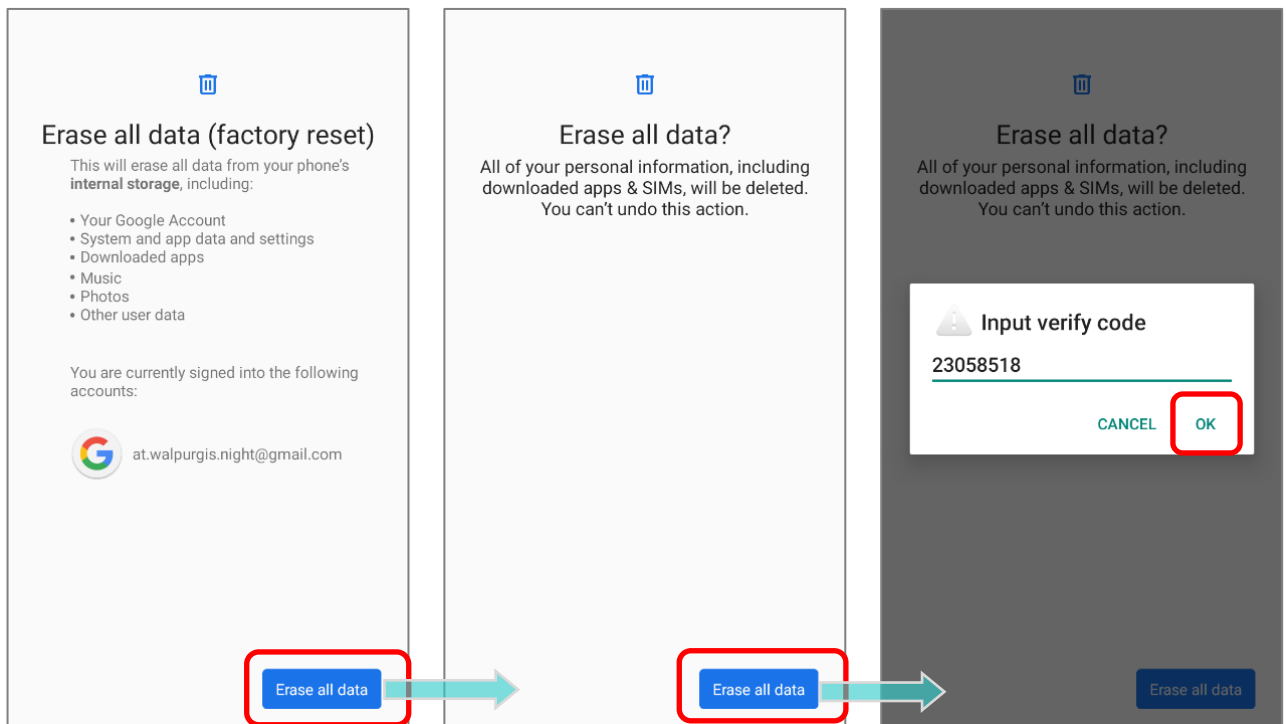

3.7.2. ERASE ALL DATA (FACTORY RESET WITH ENTERPRISE)

Go to [App Drawer \(All Apps\)](#) | **Settings**  | **System**  | **Reset options**  | **Erase all data (factory reset with enterprise)**.

Confirm the action by tapping on the button “**Erase all data**” and input the verification code (Please contact with support@cipherlab.com.tw to obtain your verification code), and tap **OK** to perform a factory reset.

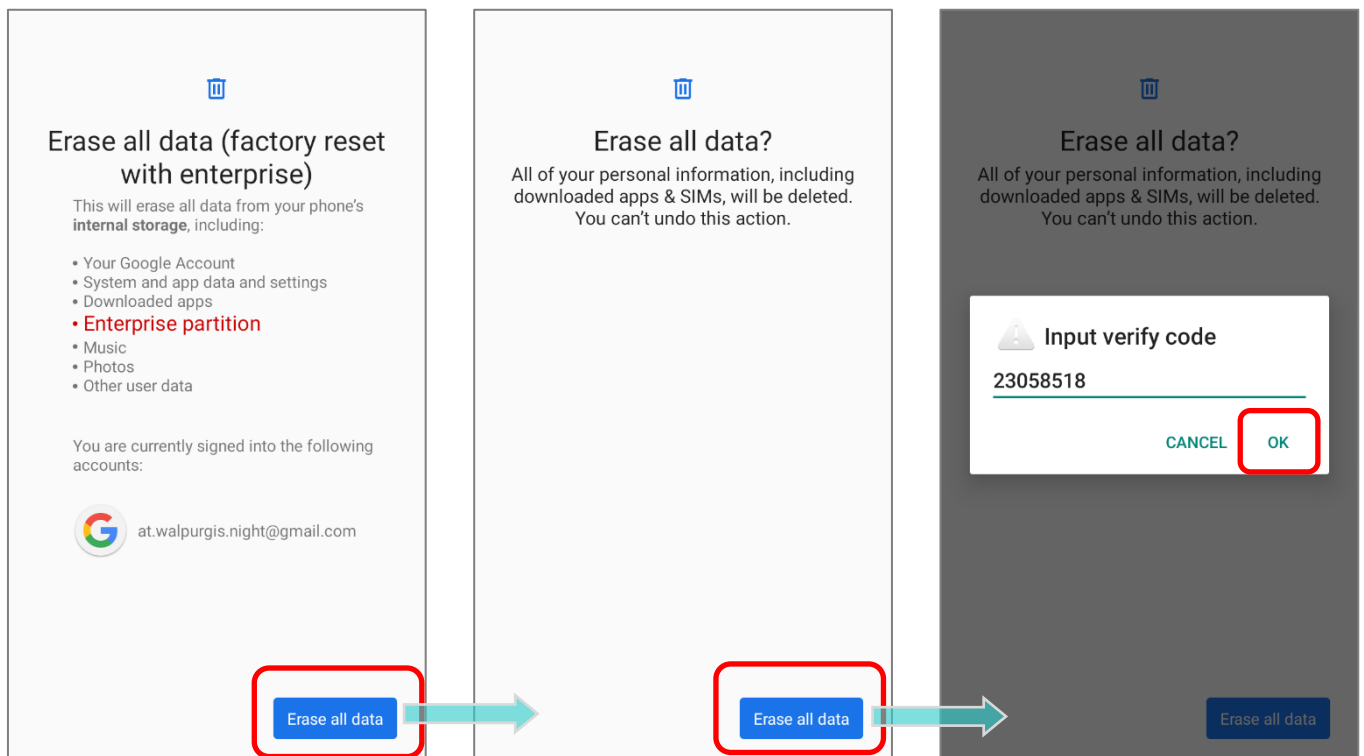

Please note that “**Erase all data (factory reset with enterprise)**” will erase all the data including the settings backed up in enterprise partition by **ADC (Android Deployment Configurator)**.

3.7.3. WELCOME WIZARD

As the mobile computer boots up for the first time after the reset, the Welcome wizard will run you through setting up the environment as well as restoring apps and data. During setup, you can tap **SKIP** to continue to the next step (you can finish the respective settings in [App Drawer \(All Application\)](#) | **Settings**  at any time).

Please note that to have the backed up data in your Google Account restored right in this stage, log in to a Wi-Fi network when prompted to **Connect to Wi-Fi**.

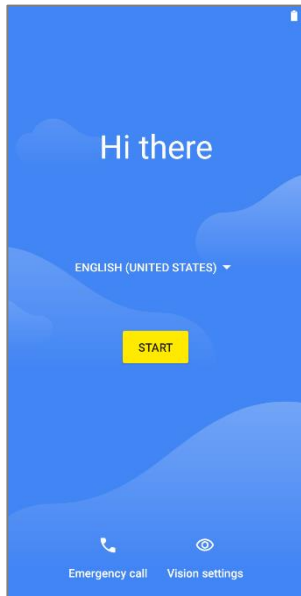

Step 1-1

Tap on “**START**” to proceed, or tap to enter “**Choose your language**” / “**Vision Settings**”.

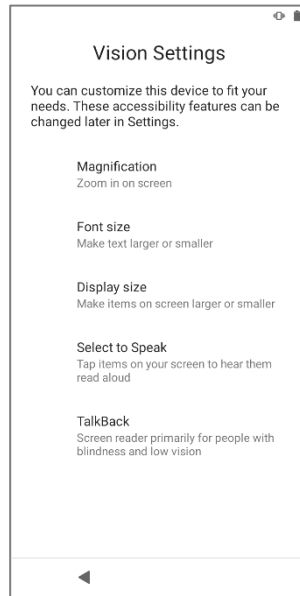

Step 1-2

Customize your device if needed.

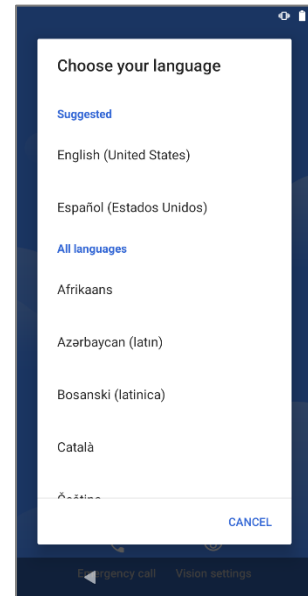

Step 1-3

Select your system language.

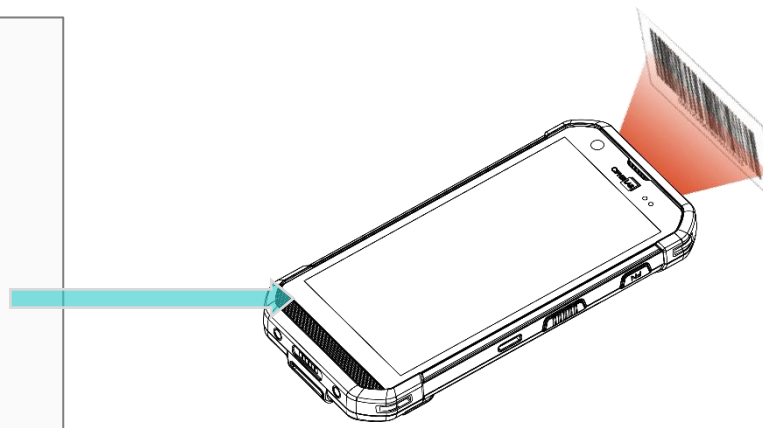
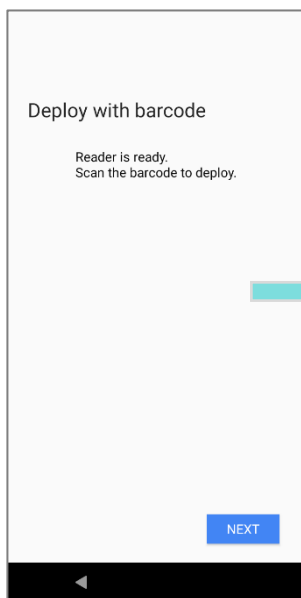

Step 2:

Press the trigger to scan the settings barcode generated by ADC (Android Deployment Configurator) to deploy the settings, or tap on “**Next**” to continue setting up by Welcome Wizard.

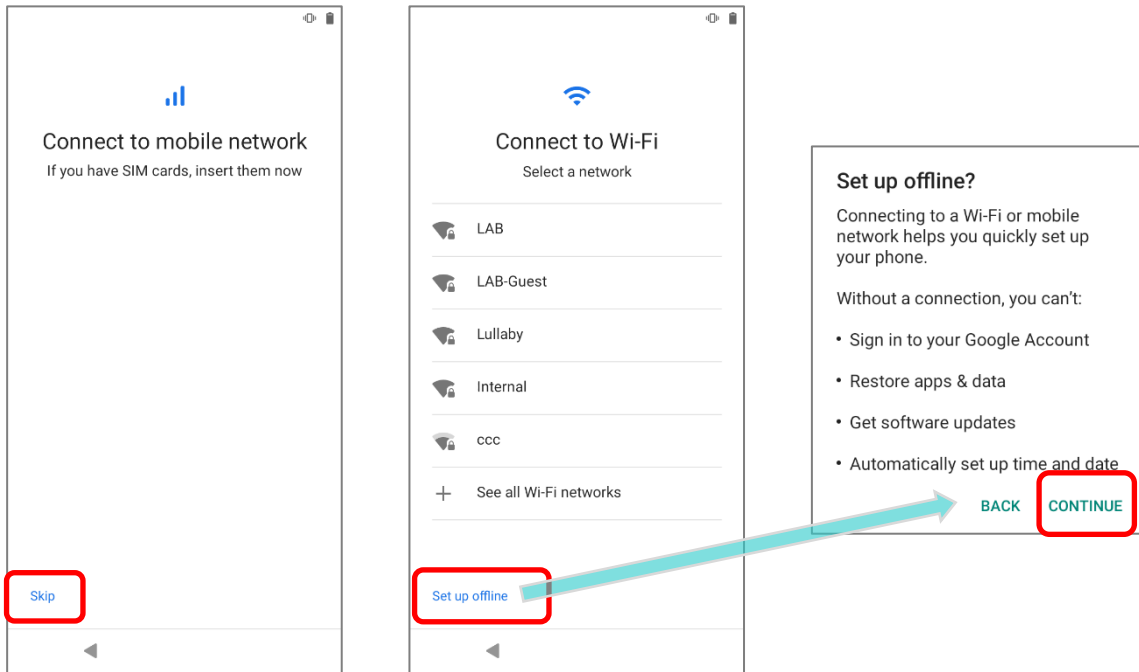

Step 3:
Insert your SIM to connect to mobile network, or tap on **“SKIP”** to the next step.

Step 4: Select a Wi-Fi network to log in or tap on **“Set up offline”** and confirm with **“CONTINUE”** to the next step.
If logged in a Wi-Fi network, you will be further asked to sign in your Google Account to restore data.

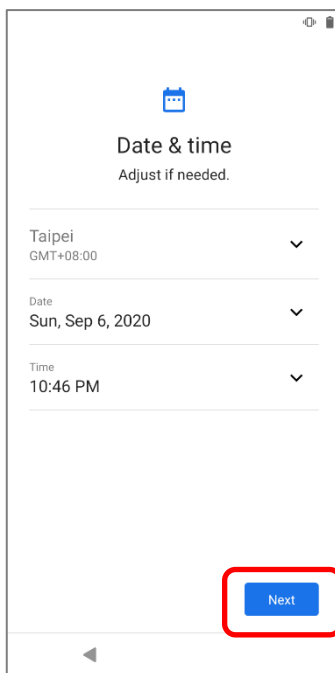

Step 5:
Set date and time, or merely skip this step by tapping **“NEXT”**.

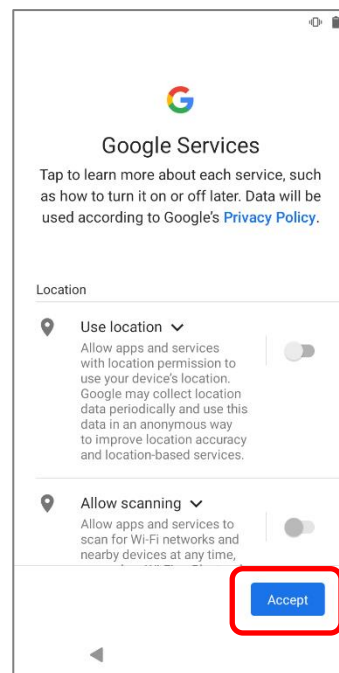

Step 6:
Choose Google services that you want to be enabled, and tap **“ACCEPT”** to proceed.

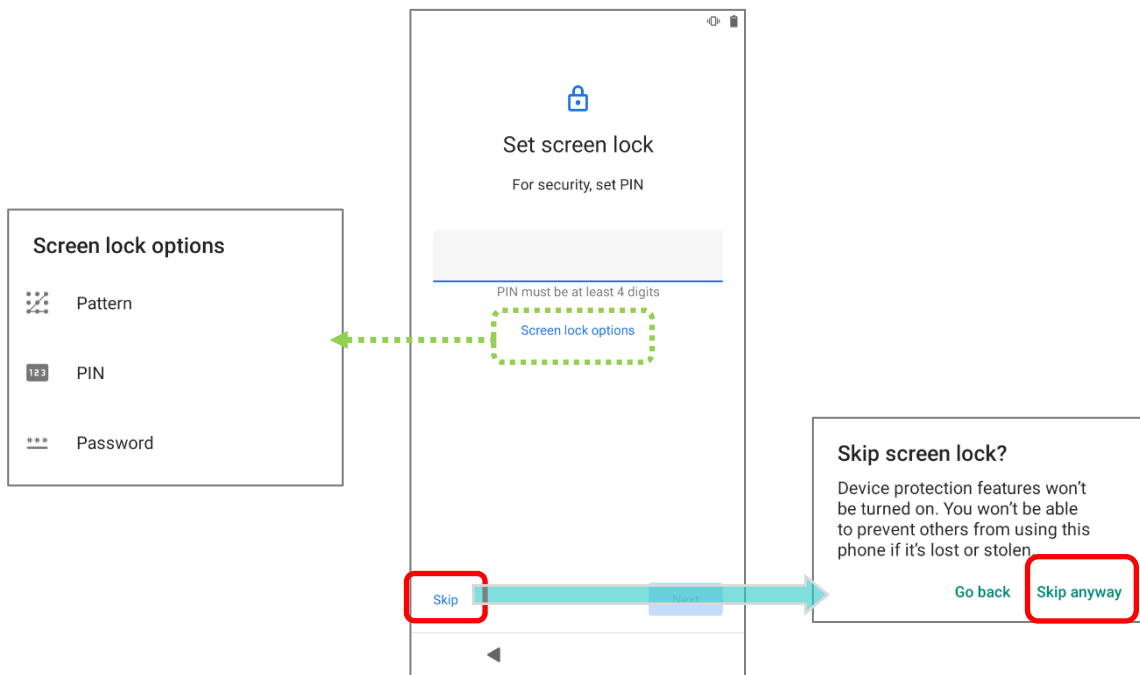

Step 7:

Set up the protection methods to protect this device, or merely **“SKIP”** this step.

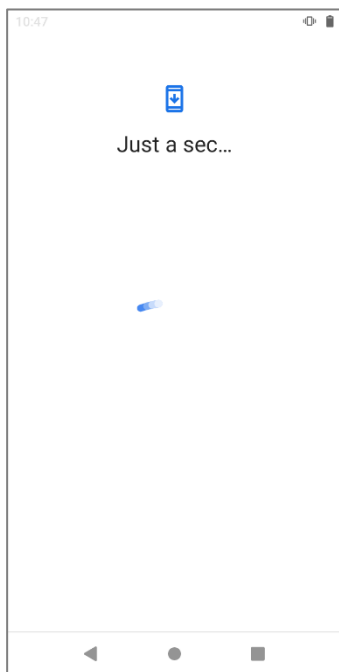

Step 8:

It takes few seconds to complete the settings.

Once the initial setup is completed, the **Home** app screen shows up. Apps and settings will be restored in the background.

Chapter 4

WIRELESS RADIOS

The Wi-Fi module integrated on the mobile computer lets you configure and connect to network wirelessly.

IN THIS CHAPTER

4.1 Use Wireless Local Area Network (Wi-Fi)	124
4.2 Use Bluetooth	133
4.3 Use Near Field Communications	139

4.1. USE WIRELESS LOCAL AREA NETWORK (WI-FI)

4.1.1. CONNECT TO WI-FI NETWORK

To power on Wi-Fi:

- 1) Go to **App Drawer** | **Settings**  | **Network & internet**  | **Wi-Fi** .

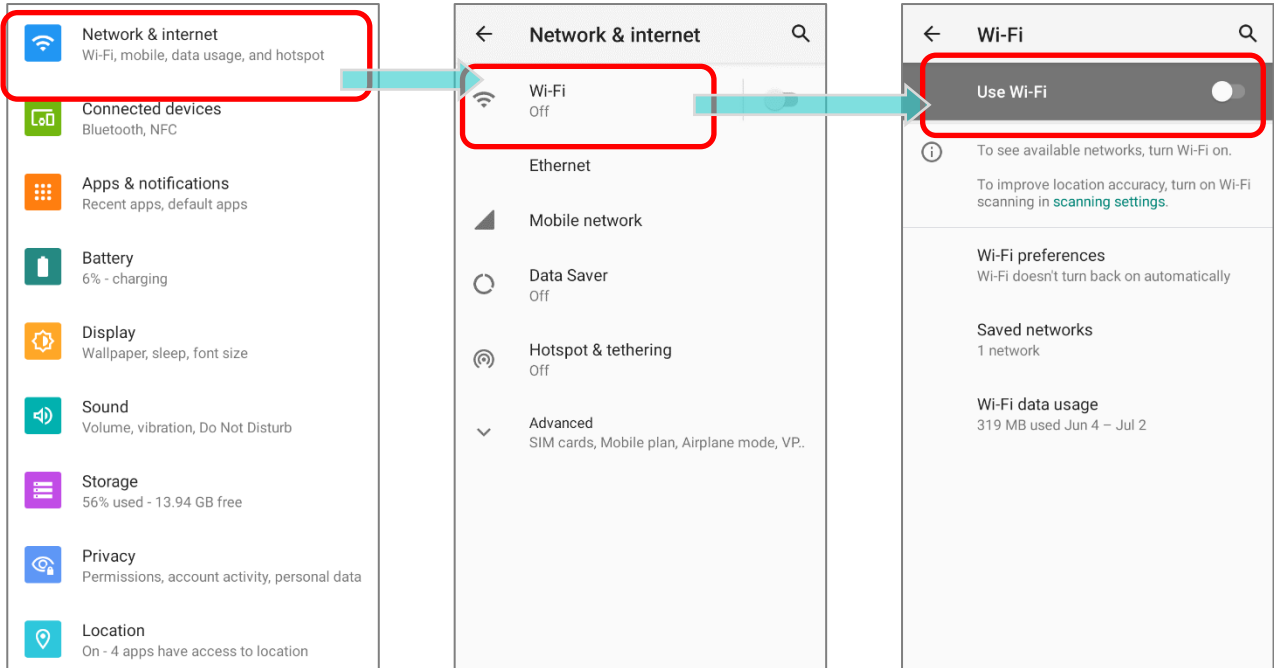

- 2) Tap the Wi-Fi switch to scan for available networks.
- 3) Select a network to connect.

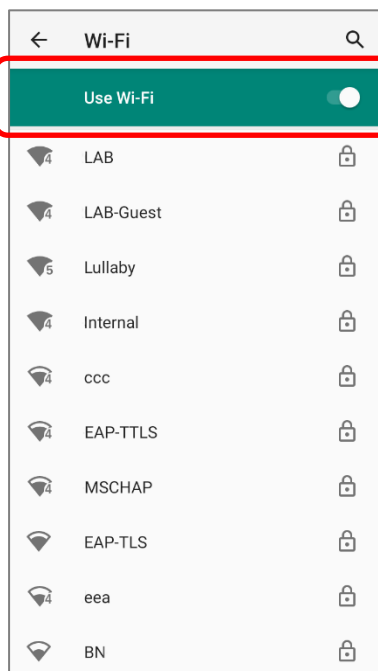

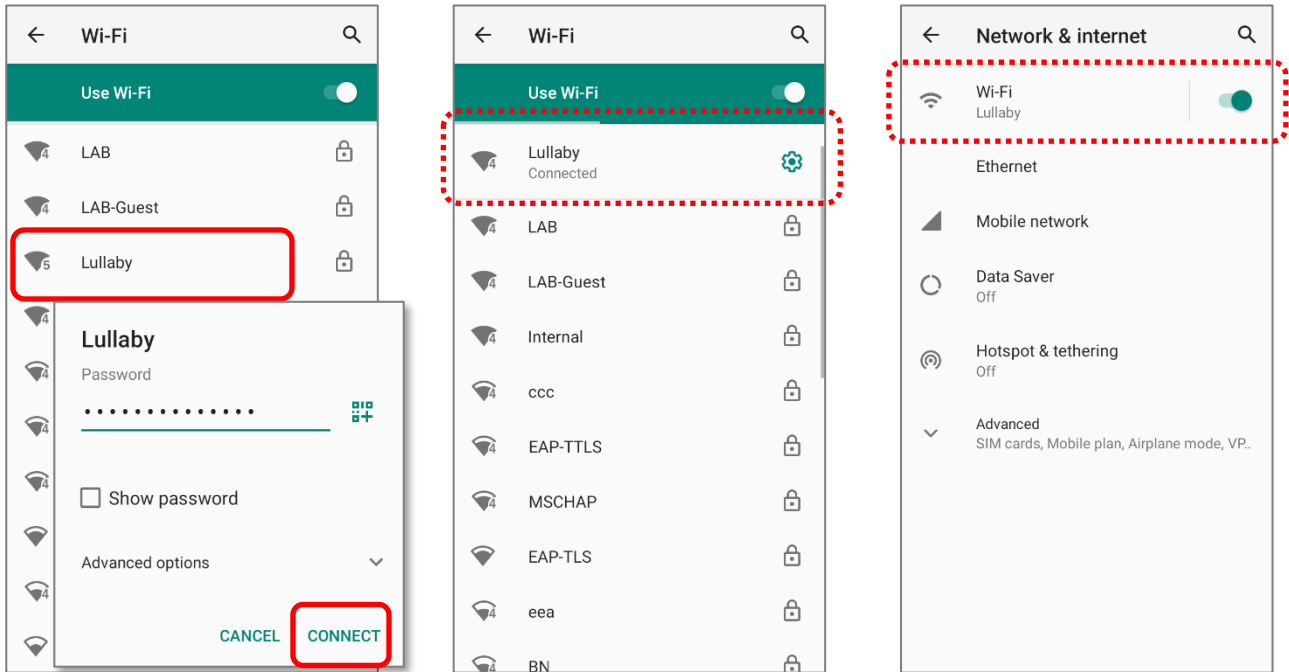

If the network is an open one, the mobile computer will attempt to connect to it directly. When connected, the status will change to show **Connected**.

If the network is a secured one, the mobile computer prompts a dialog to enter the password for the connection.



4.1.2. MANUALLY ADD WI-FI NETWORK

If the network you would like to connect to does not broadcast its SSID, or if the network is out of range, you may add it manually.

- 1) Go to [App Drawer](#) | **Settings**  | **Network & internet**  | **Wi-Fi** .
- 2) Tap the Wi-Fi switch to turn it on.
- 3) Scroll down to the bottom of the page, and select **"Add network"**.

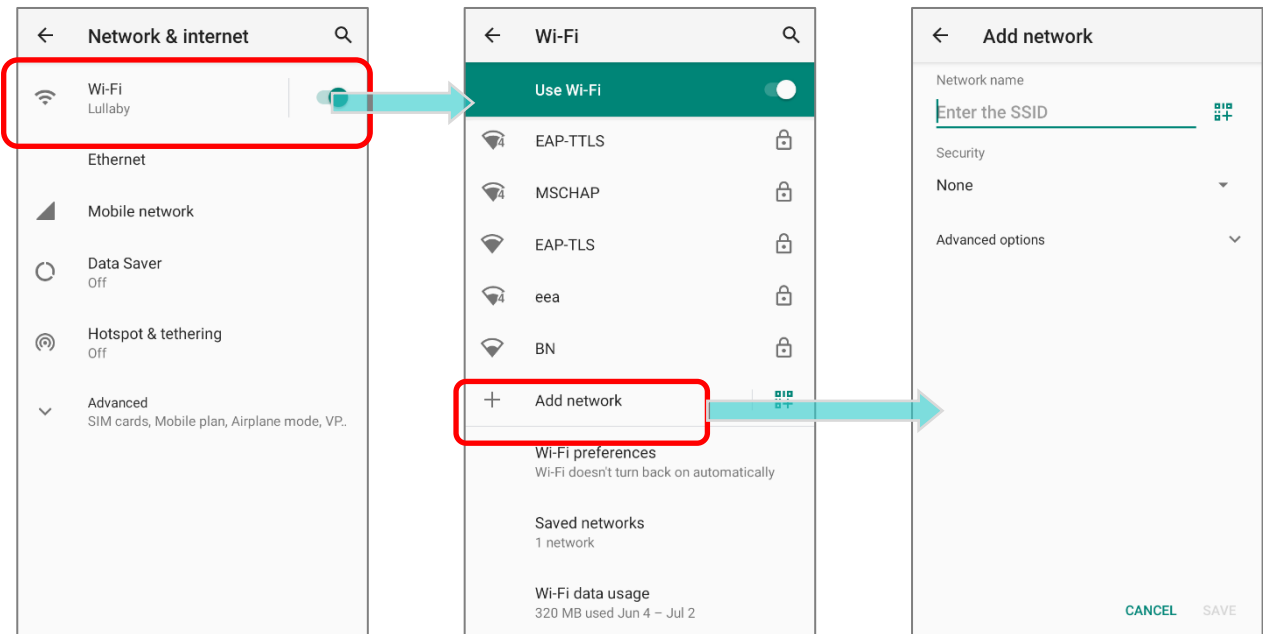

- 4) On **"Add network"** page, enter the name of the network in the **Network name** field, and select a security method.

- ▶ **Enhanced Open** is for public networks and provides no authentication.
- ▶ For **WEP**, **WPA/WPA2-Personal**, and **WPA3-Personal** connections:

Enter the required password and tap **Save**.

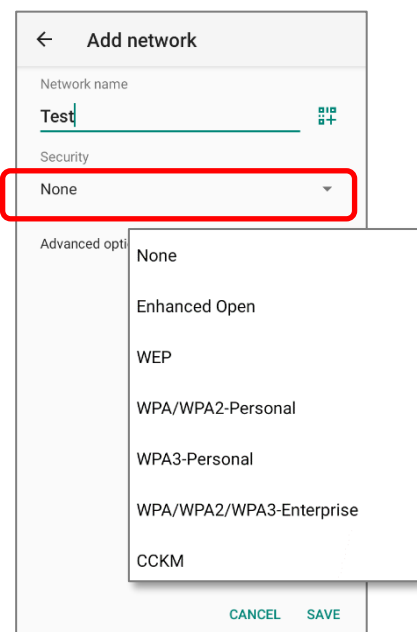



- ▶ For **WPA/WPA2/WPA3-Enterprise** and **CCKM** connections:

Select the **EAP method** in the drop-down box (PEAP, TLS, TTLS, PWD, SIM, AKA), and the **Phase 2 authentication** in the drop-down box (None, MSCHAPV2, GTC). Select a **CA certificate** and User certificate if required.

Enter your username in the Identity box and the password in the Password box if required.

Note:

Certificates may be installed under [App Drawer](#) | Settings  | Network & internet  | Wi-Fi  | Wi-Fi preferences | Advanced | Install certificates.

The mobile computer supports the following certificate file extensions:

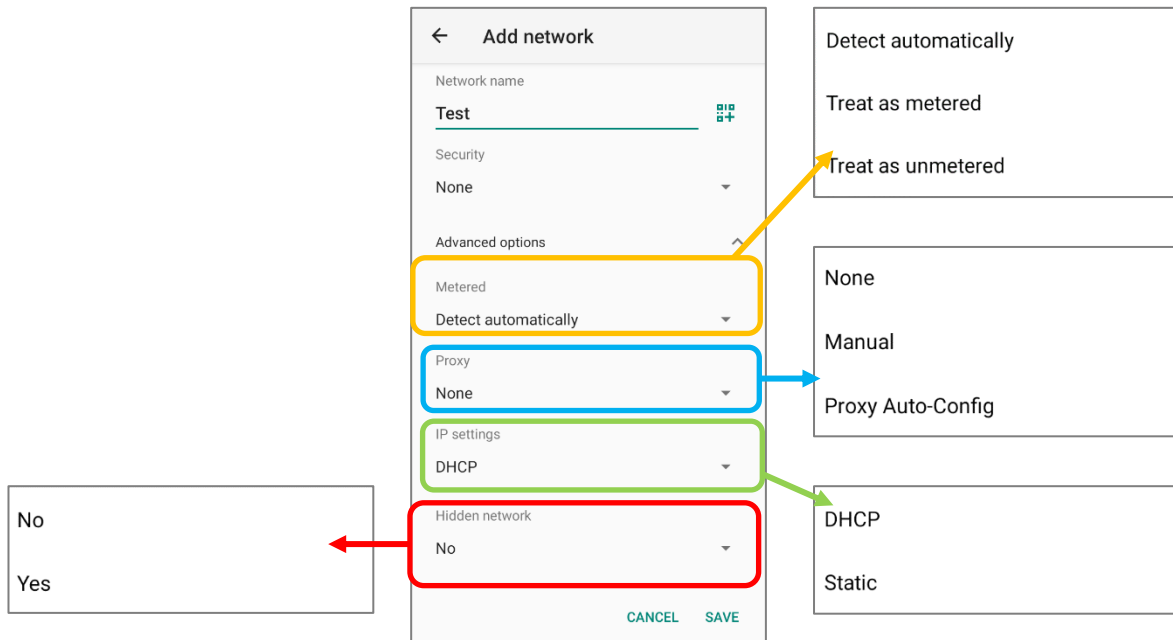

File Extension Type	Standard Certificate	Key Stored
Description	DER-encoded X.509 certificates saved in .crt or .cer files.	X.509 certificates saved in PKCS#12 key store files with a .p12 or .pfx extension.
How to install	change the extension to .crt or .cer.	Change the extension to .p12 or .pfx.

- 5) If necessary, select the **Proxy** server and **IPv4** settings. By default, no proxy is set and IP settings are set to **DHCP**.



4.1.3. ADVANCED WI-FI SETTINGS

To access advanced Wi-Fi settings:

- 1) Go to [App Drawer \(All Apps\)](#) | **Settings**  | **Network & internet**  | **Wi-Fi** 
- 2) Scroll down to the bottom of the page, and tap on **“Wi-Fi preferences”**.

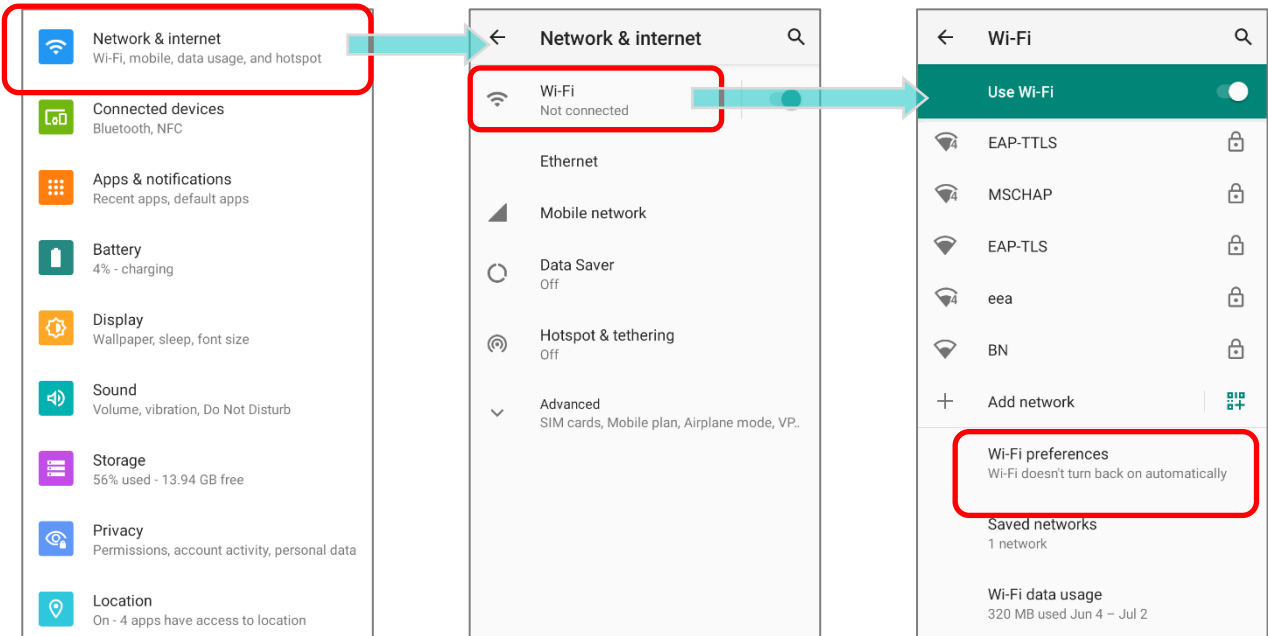

- 3) Tap **“Advanced”** to expand more settings.

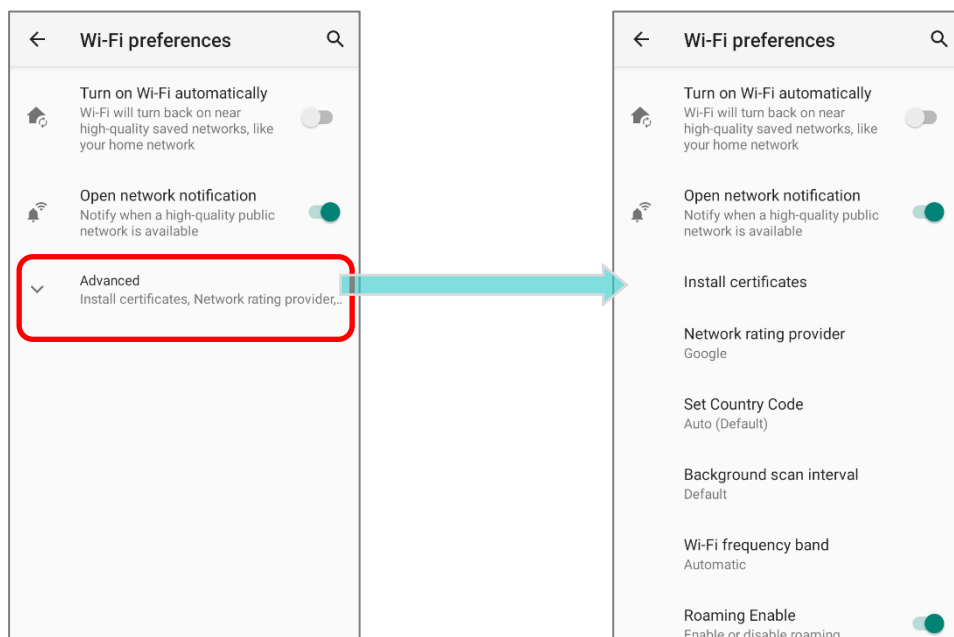

The available settings are as below:

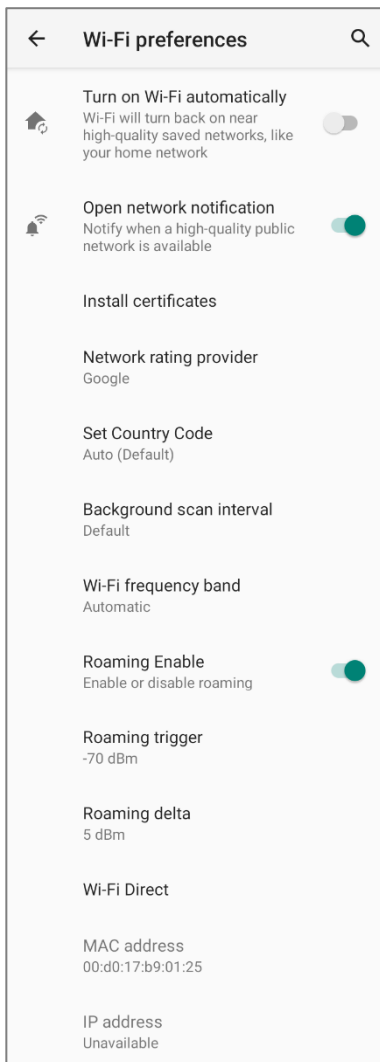

Item	Description
Turn on Wi-Fi automatically	Even you've turned off Wi-Fi, the device will automatically turn on your Wi-Fi connection when there's the saved network with a strong signal nearby.
Open network notification	Notify when an open network is available.
Install certificates	Installs certificates recently downloaded or placed on the internal storage.
Network rating provider	The selected network scorers will label the the quality of the open Wi-Fi networks you are connecting to between very fast and slow.
Set Country Code	Select the country code for your device.
Background scan interval	The frequency of background scan when the device does not connect the internet. The shorter time means the scanning frequency is higher.
Wi-Fi frequency band	Select Automatic , 5 GHz only , or 2.4 GHz only for your Wi-Fi frequency band. The default setting is Automatic .
Roaming Enable	Select whether to enable Wi-Fi roaming or not.
Roaming trigger	The signal strength when triggering Wi-Fi roaming. The higher value means the sensitivity of triggering roaming is higher.
Roaming delta	The qualification for roam candidates. The higher value means the signal strength of candidate APs should be higher than the current connected AP.
Wi-Fi Direct	Enables your device to connect with a Wi-Fi Direct-capable device.
MAC address	Displays the MAC address of the device when connecting to Wi-Fi networks.
IP address	Displays the IP address of the device.

4.1.4. MODIFY WI-FI NETWORK

MODIFY THE CONNECTED NETWORK

To change the settings for a connected network:

- 1) Tap a connected network in the Wi-Fi hotspot list to enter its **"Network details"** page.
- 2) Tap **Edit** button to open the pop-up menu.

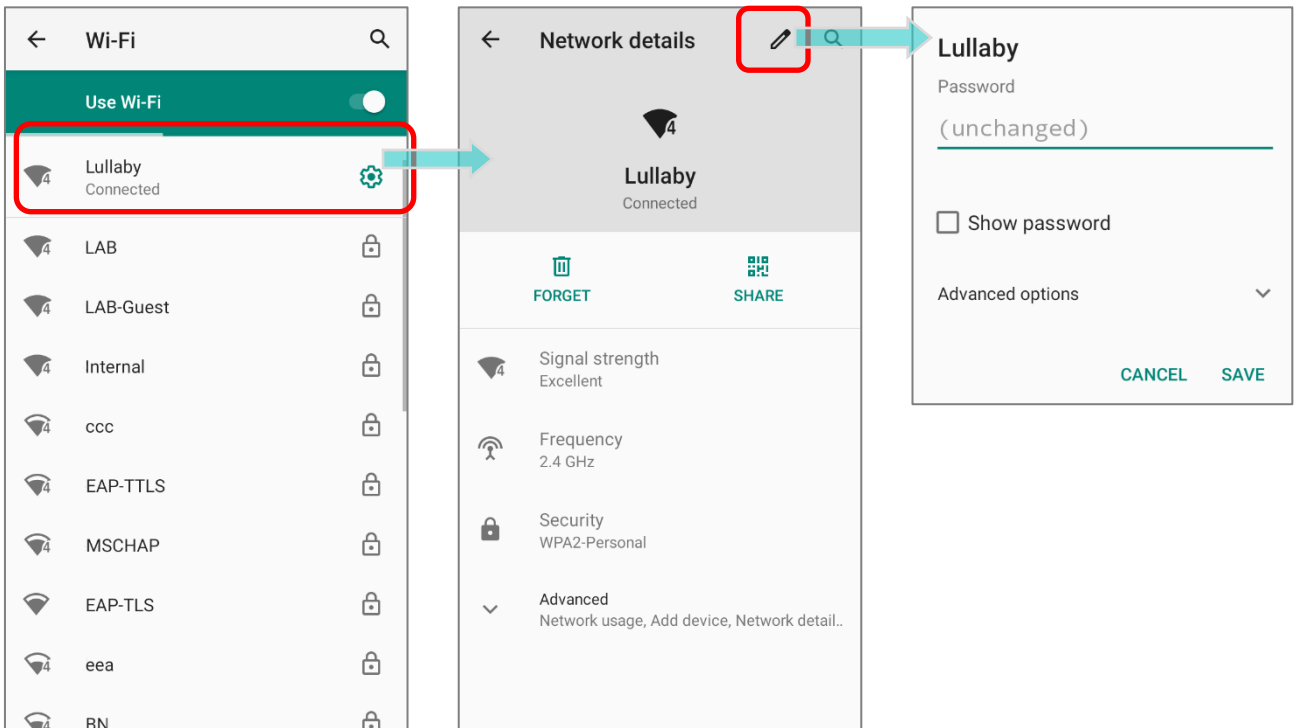

- 3) Modify the network settings, and tap **Save**.

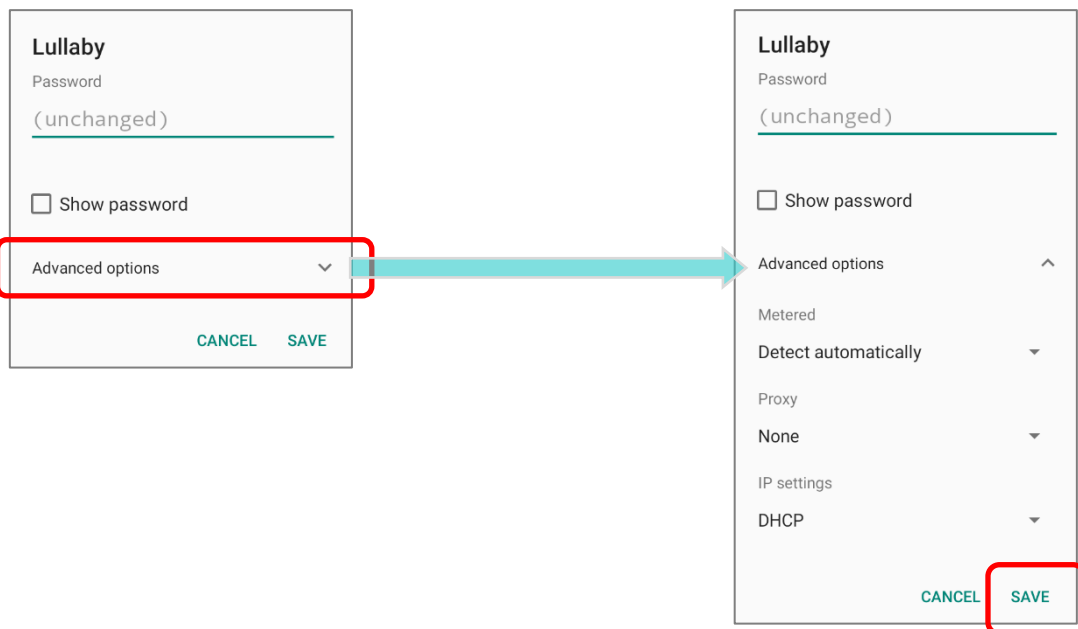

MODIFY THE SAVED NETWORK

To change the settings for a saved network:

- 1) Tap and hold a saved network in the Wi-Fi hotspot list.
- 2) Tap **Modify network** in the pop-up menu.
- 3) In the dialog box that opens, modify the network settings, and tap **Save**.

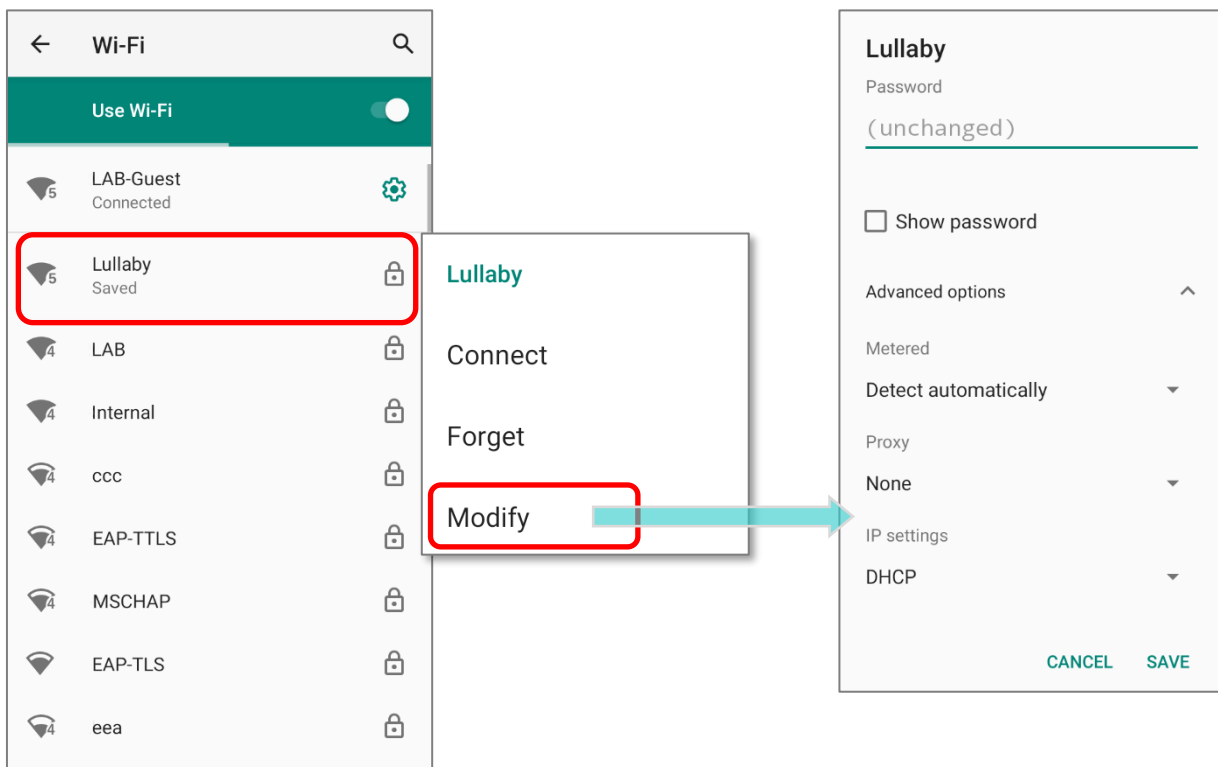

4.1.5. DISCONNECT WI-FI NETWORK

To disconnect a connected network:

- 1) Tap a connected network in the Wi-Fi hotspot list to enter its **"Network details"** page.
- 2) Tap **FORGET** button to disconnect.

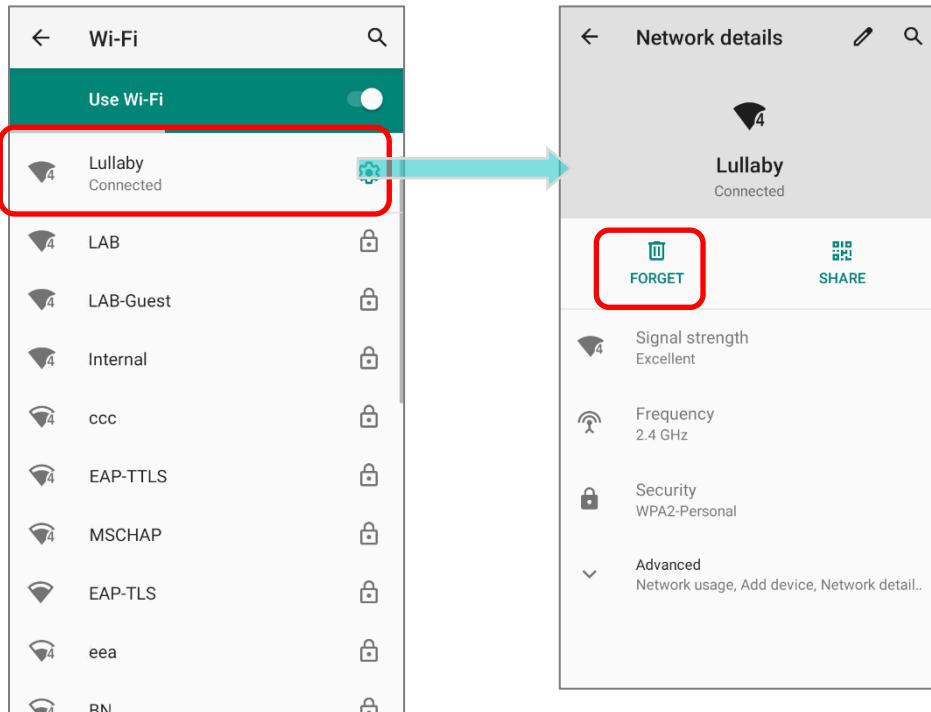

OR

- 1) Tap and hold a connected network in the Wi-Fi hotspot list.
- 2) Tap **Forget network** in the pop-up menu.

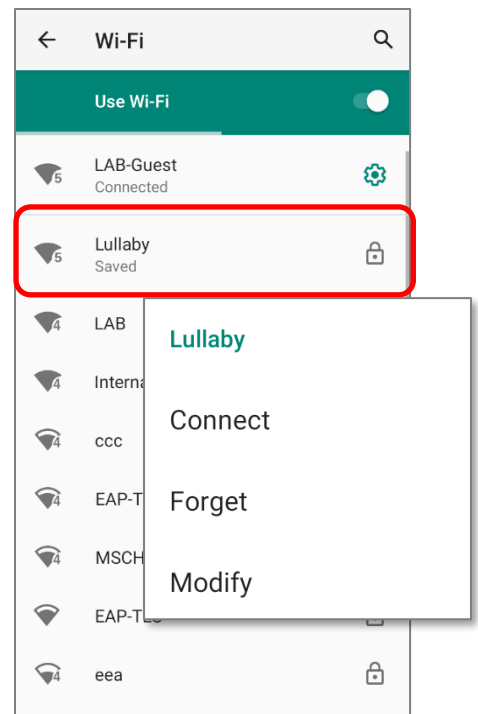

4.2. USE BLUETOOTH

The RS35 mobile computer lets you configure Bluetooth settings and manage Bluetooth services provided on remote devices.

4.2.1. BLUETOOTH PROFILES

Bluetooth Profiles Supported

Generic Access Profile	(GAP)	For device discovery and authentication.
Service Discovery Access Profile	(SDAP)	Discovers services on remote devices.
Headset Profile	(HSP)	Describes how a Bluetooth enabled headset should communicate with a Bluetooth enabled device
Serial Port Profile	(SPP)	Sets up a virtual serial port to connect two Bluetooth devices.
Human Interface Device Profile	(HID)	Provides a low latency Bluetooth connection with keyboards, pointing devices, etc.
Object Push Profile	(OPP)	Pushes and pulls objects to and from a push server.
Hands-Free Profile (AG1.5)	(HFP)	Allows using a hands-free device to place and receive calls.
Hands-Free Profile	(HFP 1.6)	Allows using a hands-free device to place and receive calls.
Advanced Audio Distribution Profile	(A2DP)	Streams stereo-quality audio to a wireless headset or speaker.
Audio/Video Remote Control Profile	(AVRCP)	Allows controlling of television and Hi-Fi equipment.
Generic Object Exchange Profile	(GOEP)	Provides a basis for other data profiles.
Personal Area Networking Profile	(PAN)	Uses Bluetooth Network Encapsulation Protocol for Bluetooth transmission.
General Audio/Video Distribution Profile	(GAVDP)	Provides a basis for A2DP and VDP.
Phone Book Access Profile	(PBAP)	Transfers Phone Book Objects to a car kit to display the information of an incoming call received on the mobile computer, or initiate a call.
Out of band and Near Field Communications	(OOB, NFC)	Manages the pairing process by using NFC.
Symbol Serial Interface Profile	(SSI)	Supports additional scanner.
Dial-up Networking Profile	(DUN)	Provides a standard to access the Internet and other dial-up services over Bluetooth.
HID over GATT Profile	(HOGP)	Defines the communication between a BLE (Bluetooth Low Energy) device and a host device.
Generic Attribute Profile	(GATT)	Defines how BLE (Bluetooth Low Energy) devices transfers data.

4.2.2. TURN ON BLUETOOTH

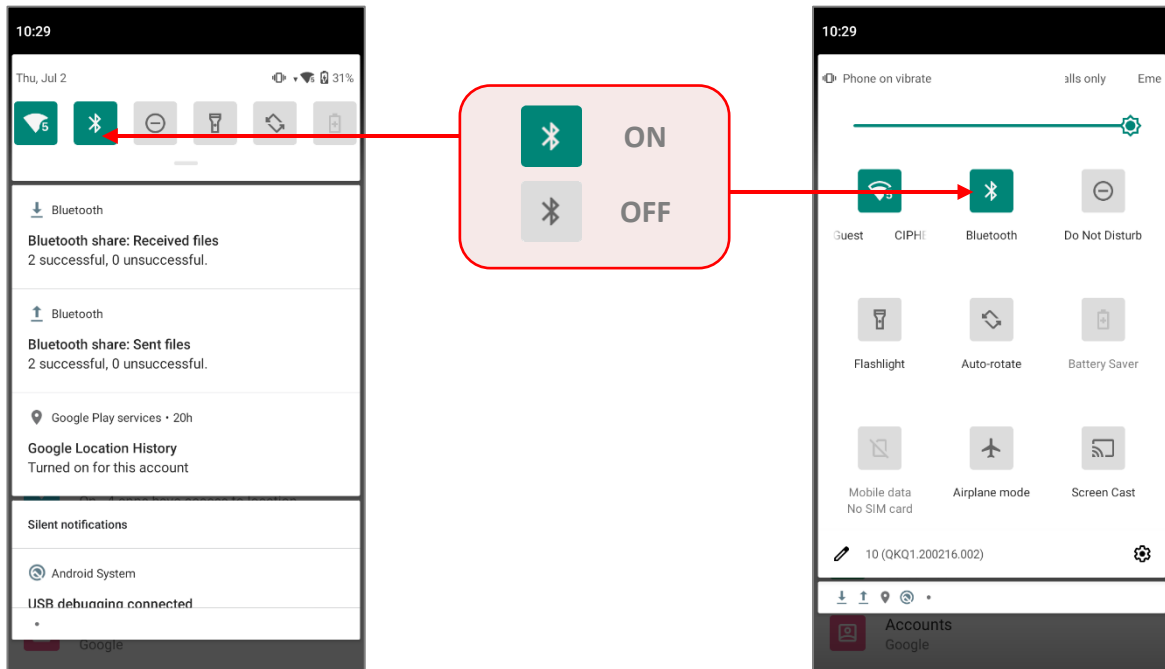

Bluetooth is turned off by default, and you can turn it on by tapping the Bluetooth icon  on **Quick Settings Menu** or **Quick Settings Panel**:

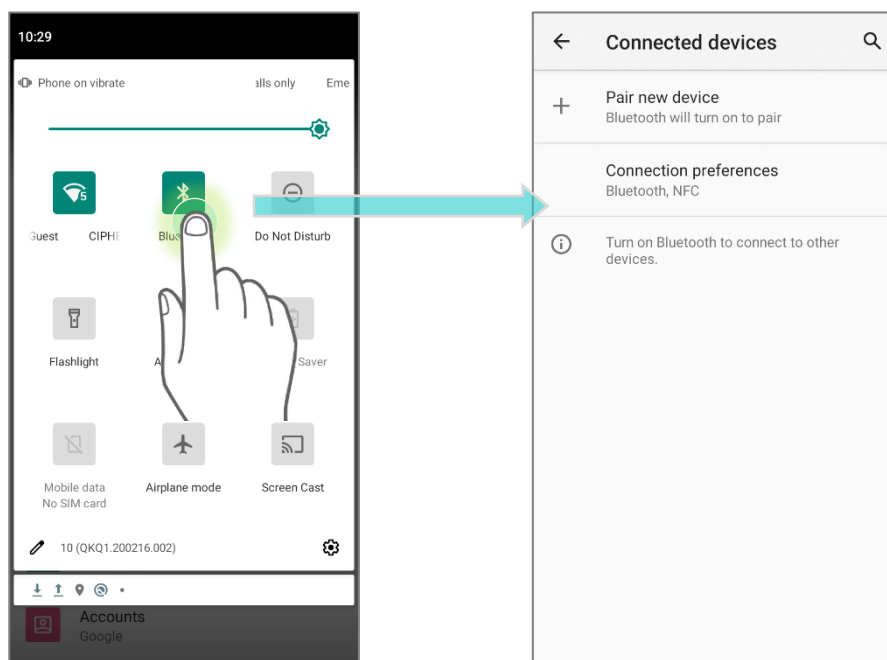

To enter “**Connected devices**” page for further Bluetooth settings, please long press the Bluetooth icon  on **Quick Settings Menu** or **Quick Settings Panel**:



OR

- 1) Go to [App Drawer \(All Application\)](#) | **Settings**  | **Connected devices**  | **Connection preferences** | **Bluetooth** .
- 2) Tap the switch to turn on this function while enabling the Bluetooth visibility of this device.

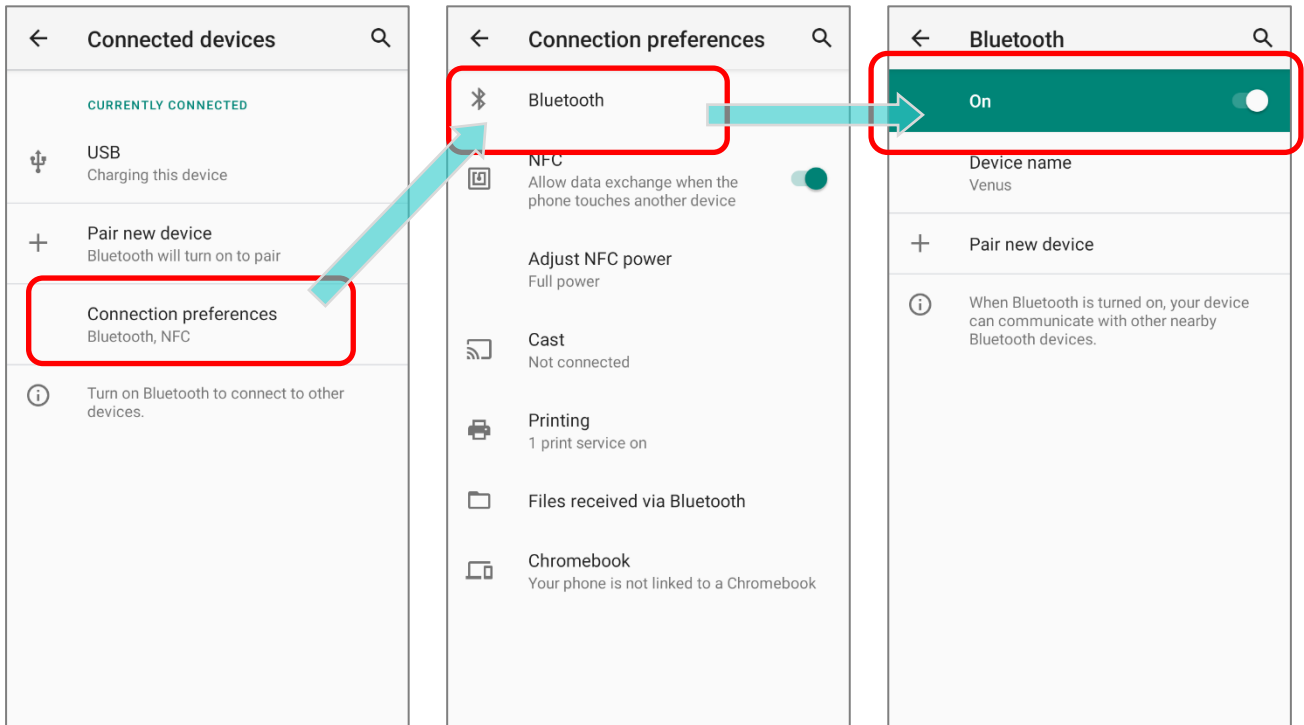



Note:

Having been turned on, Bluetooth is active even when the mobile computer is suspended. However, if the power mode is switched to Airplane Mode, Bluetooth power will be turned off regardless of the settings.



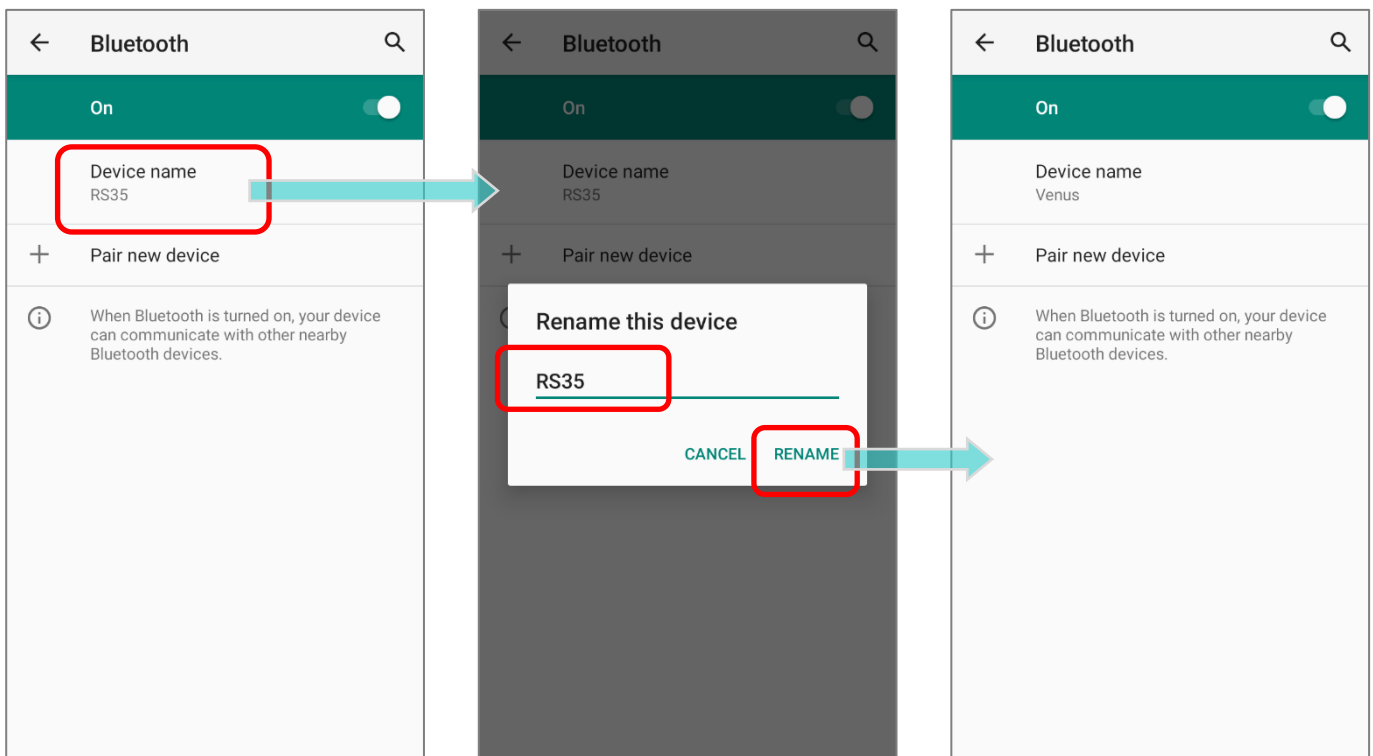

4.2.3. CHANGE BLUETOOTH NAME

To change the Bluetooth name of this mobile computer:

- 1) Go to [App Drawer \(All Application\)](#) | **Settings**  | **Connected devices**  | **Connection preferences** | **Bluetooth** .
- 2) Tap "**Device name**" and the pop-up window "**Rename this device**" shows up.
- 3) Enter a new name in the field and tap **RENAME**.



4.2.4. PAIR BLUETOOTH DEVICES

- 1) Go to [App Drawer](#) | [Settings](#)  | [Connected devices](#)  | [Connection preferences](#) | [Bluetooth](#) . Tap the switch to **On** to scan for available Bluetooth devices nearby. Scroll through the list and tap the device you would like to pair.
- 2) The **Bluetooth pairing request** window opens. Depending on the pairing settings of the Bluetooth device, you may need to enter a passkey, or confirm the assigned passkey on the device to pair if a smart pairing method is applied. Enter/confirm the passkey on the device to pair.
- 3) Once pairing is done, you can find the Bluetooth device in [App Drawer](#) | [Settings](#)  | [Connected devices](#)  | [Previously connected devices](#).

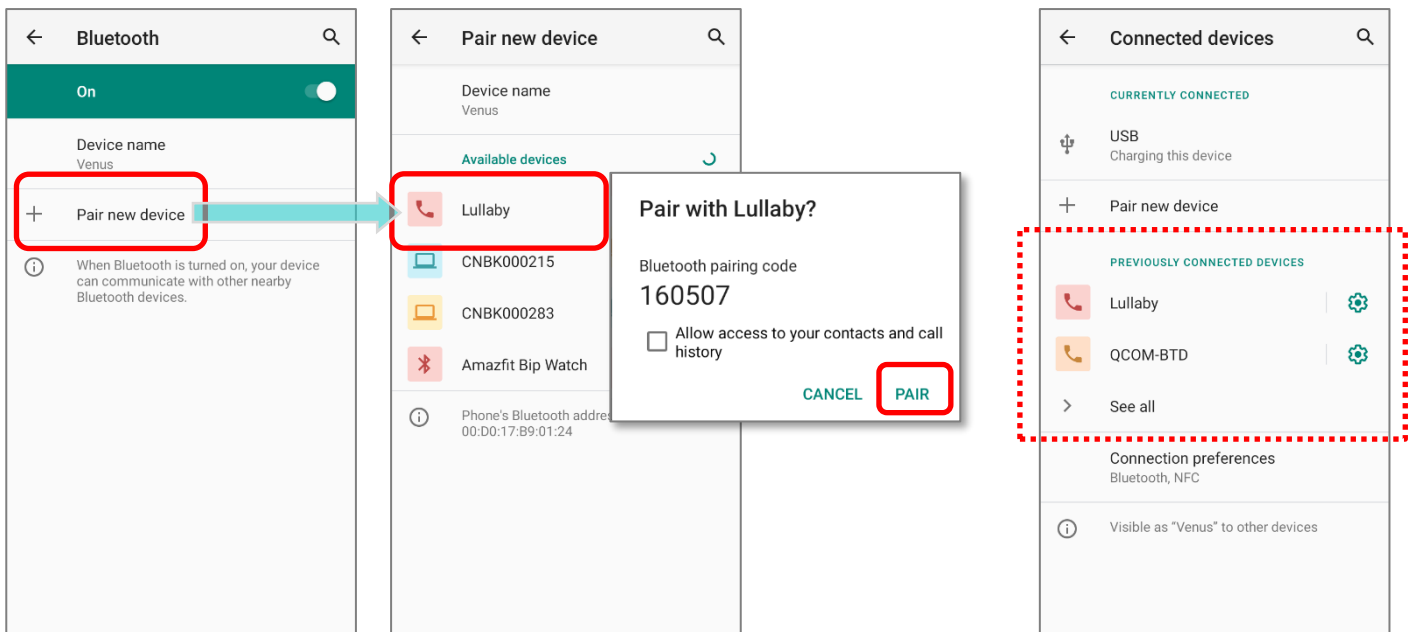

Note:

If the device you would like to pair with is not listed, make sure Bluetooth visibility is enabled on the device.

4.2.5. UNPAIR BLUETOOTH DEVICE

To unpair a paired device:

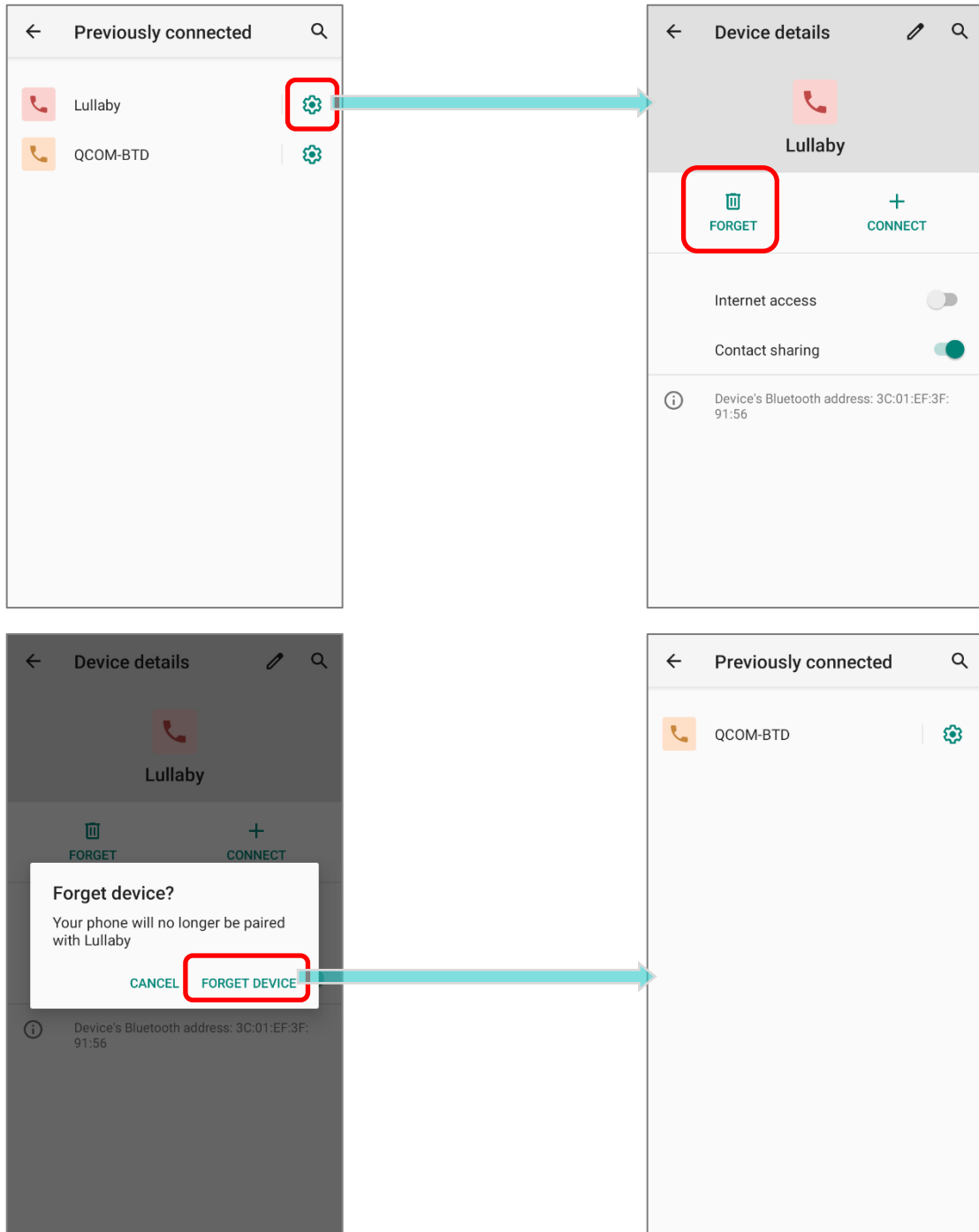

- 1) In the **Previously connected devices** list, tap the settings button  next to the paired device.
- 2) On the **Device details** screen, tap **FORGET**.



4.3. USE NEAR FIELD COMMUNICATIONS

Near field communications (NFC) uses close proximity (4 cm or less) to establish radio communication through electromagnetic fields. With NFC enabled, the mobile computer can collect information from NFC tags, exchange information with other NFC supported devices, and even change information on the NFC tag if authorized.

Before starting to communicate through NFC, perform the following:

- 1) Go to [App Drawer \(All Application\)](#) | **Settings**  | **Connected devices**  | **Connection preferences**.
- 2) On **"Connection preferences"** page, tap to switch on **"NFC"**  .

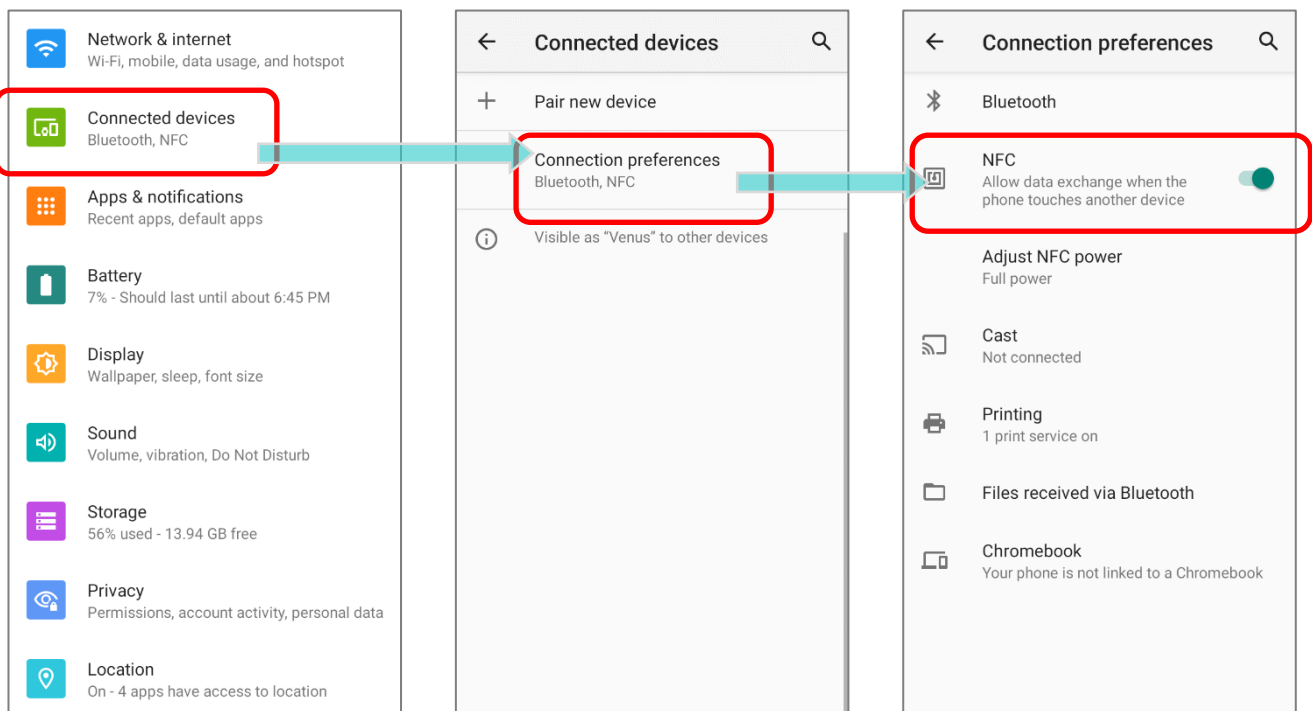

You can tap on **"Adjust NFC power"** to select the NFC power between **"Full power"** and **"Low power"**.

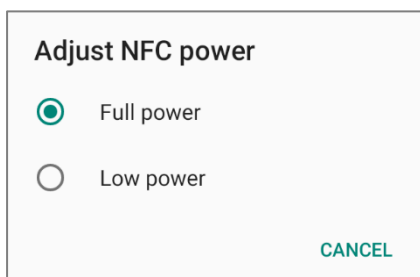

PAIR WITH NFC ENABLED BLUETOOTH DEVICES

- 1) On the device you would like to pair with, make sure NFC is enabled and Bluetooth discovery is enabled.
- 2) Hold the mobile computer without covering the antenna area.

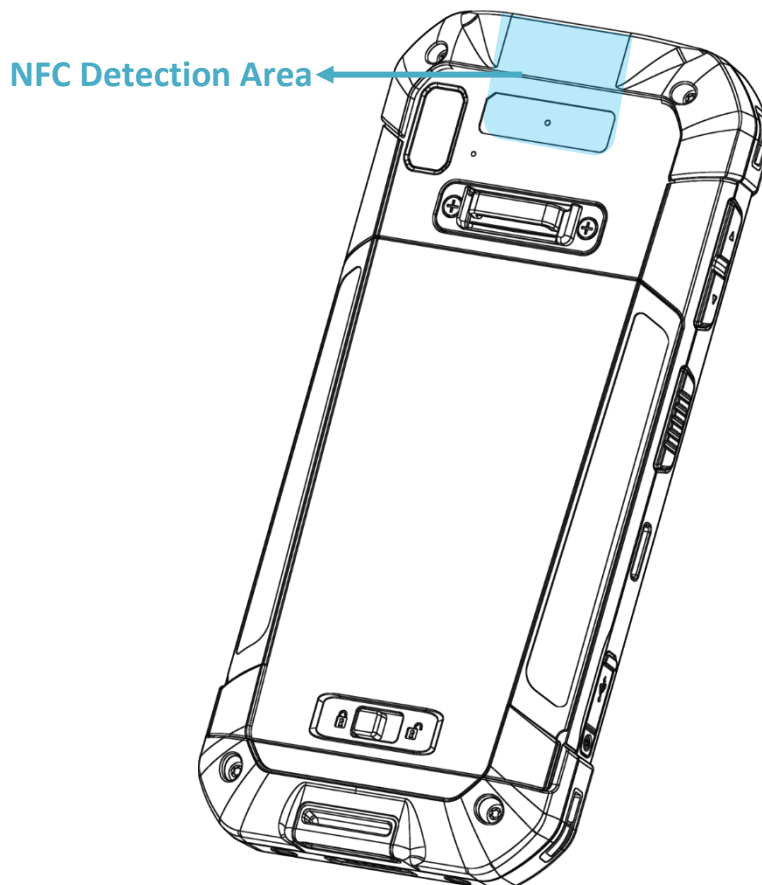

- 3) Move the mobile computer in proximity with the device for pairing. A screen notification will appear to indicate that pairing is successful.

COMMUNICATION WITH NFC

- 1) On the mobile computer, launch an NFC enabled application.
- 2) Hold the mobile computer without covering the antenna area.
- 3) Place the mobile computer close to the NFC tag or device until the application indicates data transfer is complete.

Chapter 5

USING THE PHONE

The RS35 mobile computer allows making phone calls and connecting to the network over Wideband Code Division Multiple Access (WCDMA). Insert the SIM card before turning on the power. Refer to [Installing SIM Card, SAM Card, and Memory Card](#).

Note:

SIM card slots are optional.

IN THIS CHAPTER

5.1 SIM Card Management.....	142
5.2 Phone Application.....	144
5.3 Audio Modes.....	153
5.4 In-call Volume	154

5.1. SIM CARD MANAGEMENT

The default setting for cellular networks is “**Automatically select network**”. To manually select the cellular network, please:

- 1) Go to [App Drawer \(All Apps\)](#) | **Settings**  | **Network & Internet**  | **Mobile Network** .

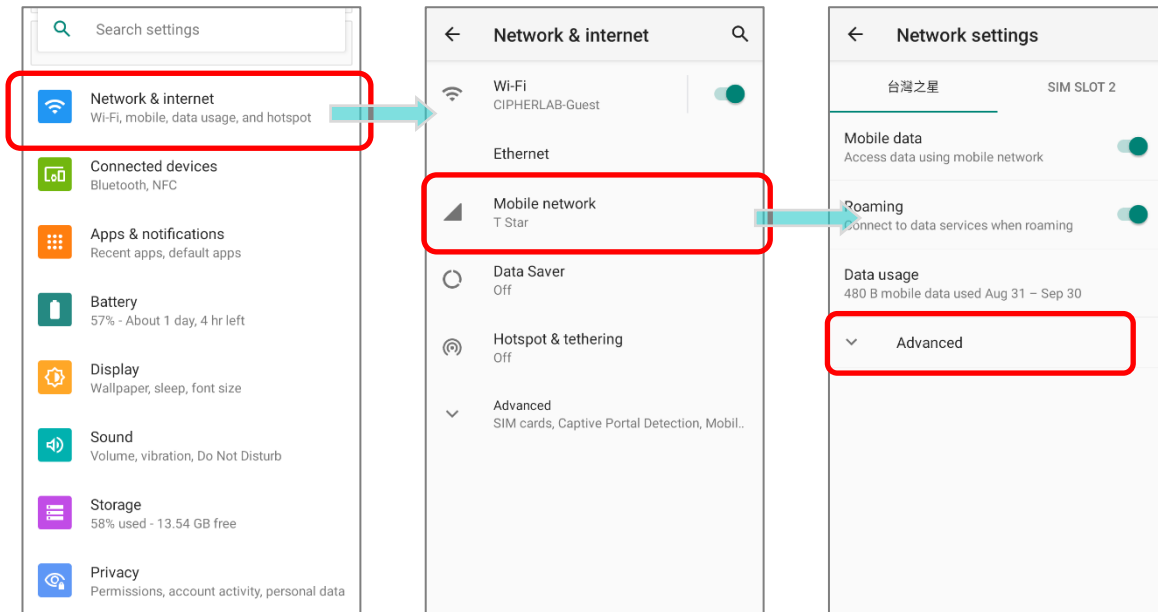

- 2) In “**Network Settings**” page, tap on “**Advanced**” to display more functions, and disable “**Automatically select network**”, and tap on “**Network**”. Available networks will be listed after searching.

- 3) Select your preferred network from the list.

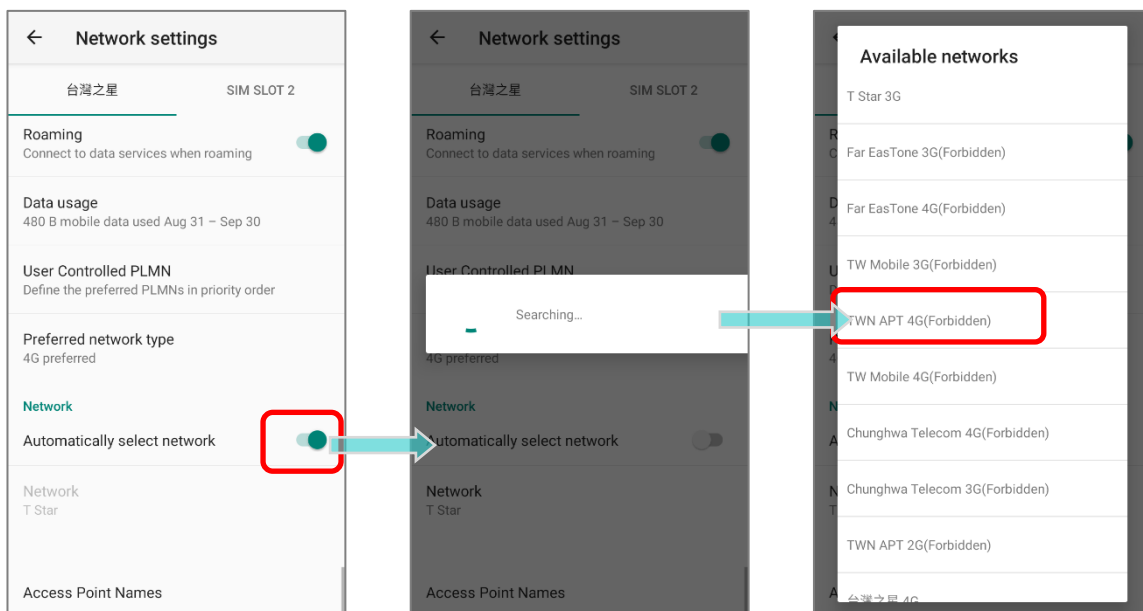

- 4) A notification appears if the selected network is unavailable. Please repeat the aforesaid steps to select the network again.

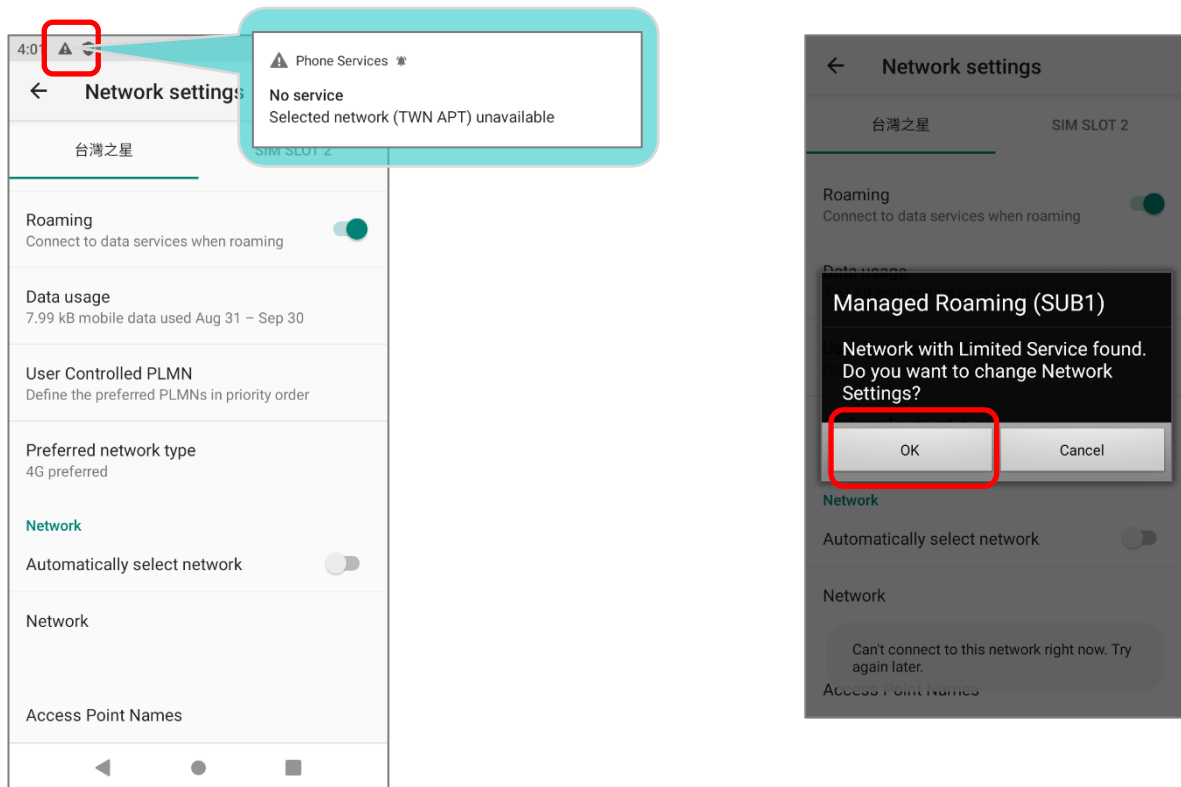

Note:

SIM card slots are optional.

EMERGENCY CALLS

Depending on your service provider, the mobile computer might support making emergency phone call when the SIM card is locked, or even when no SIM card is inserted. Emergency phone numbers will vary by country.

5.2. PHONE APPLICATION

When a SIM card is installed on the mobile computer, a signal icon appears on the bottom of the Quick Settings Menu to indicate the signal strength of the connection.

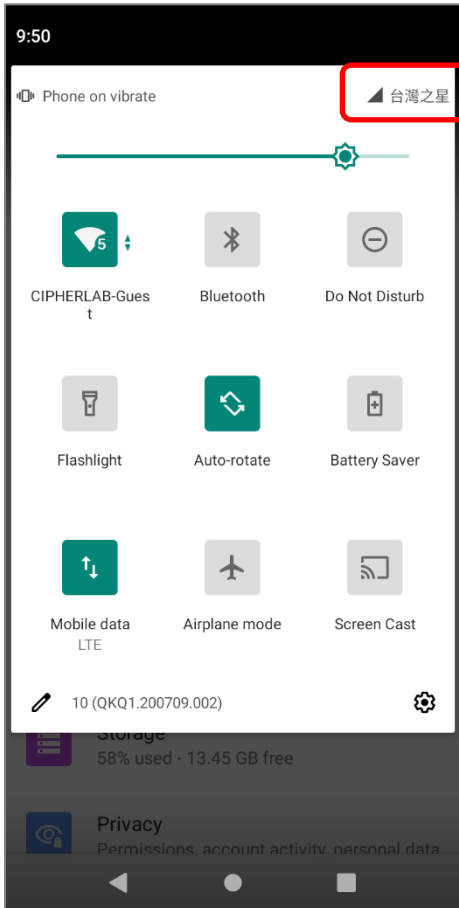

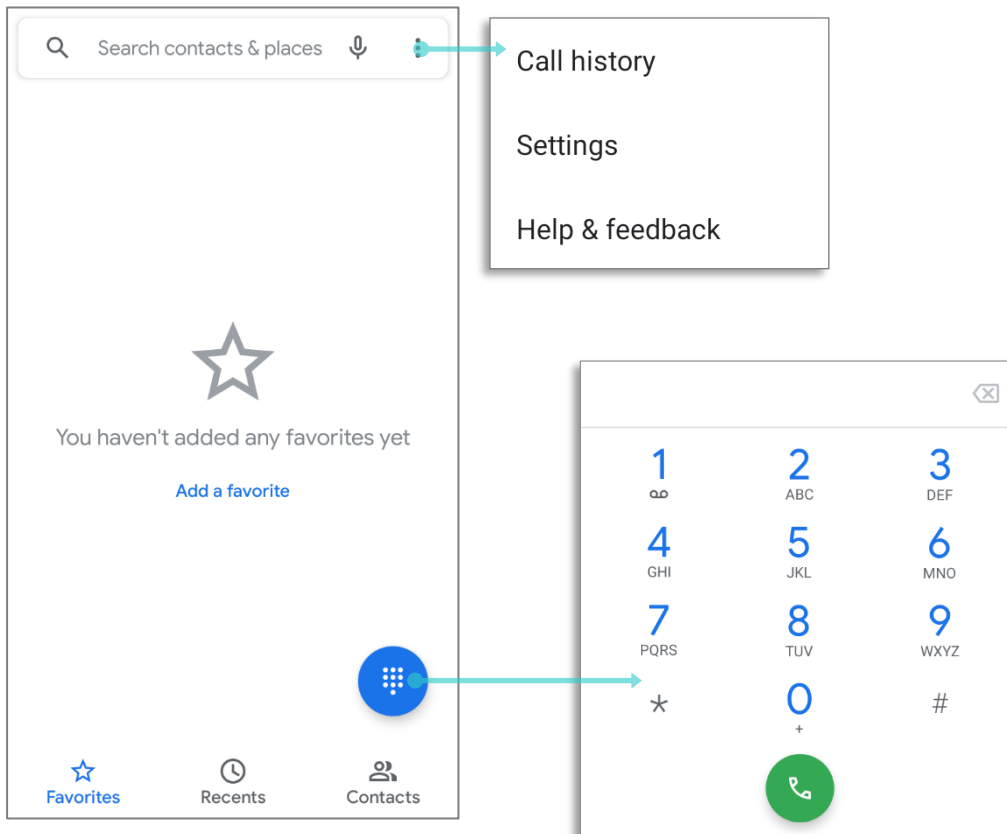

5.2.1. PHONE INTERFACE

To launch the phone application, please go to [App Drawer \(All Apps\)](#) | **Phone** .



The application "**Phone**" contains 3 tab pages:

Item	Description
 Favorites	Display your favorite contacts & your frequent calls.
 Recents	List all the call history.
 Contacts	List your contacts.

ADD FAVORITE CONTACTS

Your favorite contacts are displayed on **"Favorite"** ☆ tab pages for quickly making phone calls. To add a favorite contact:

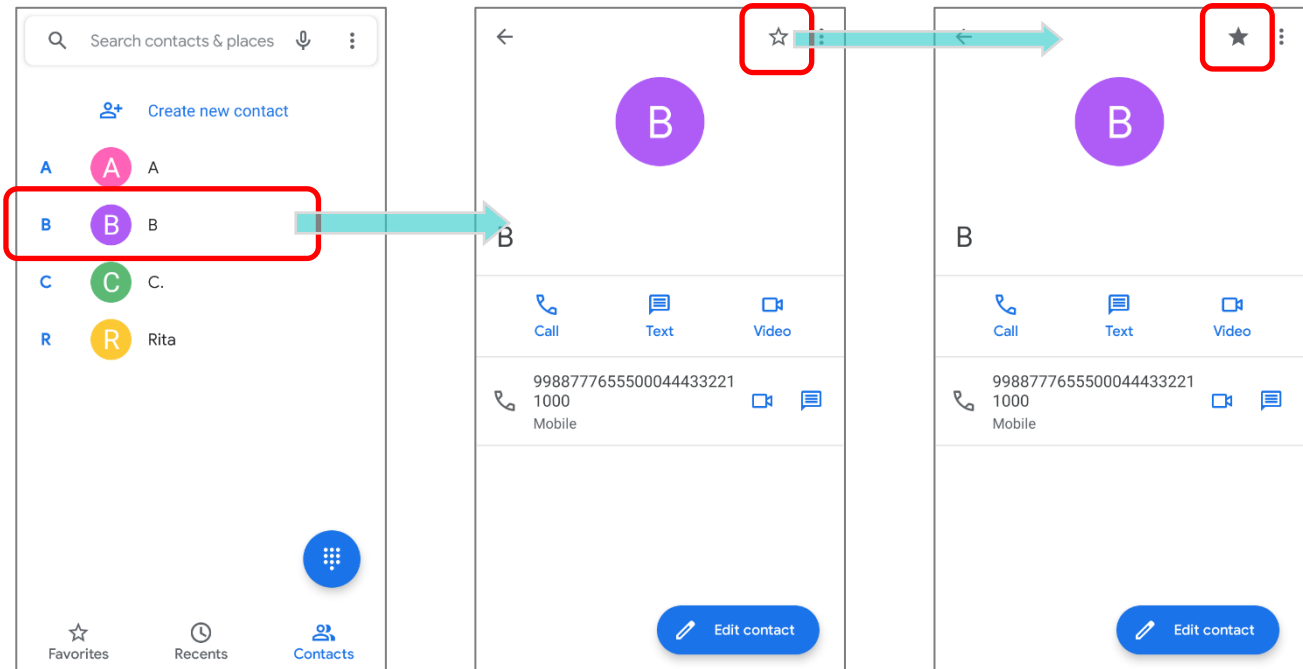

- 1) On **"Contacts"** 👤 tab page, tap on the contact you would like to set to be your favorite to enter the contact detail page.
- 2) Tap on the start mark on the upper-right to mark this contact as your favorite.

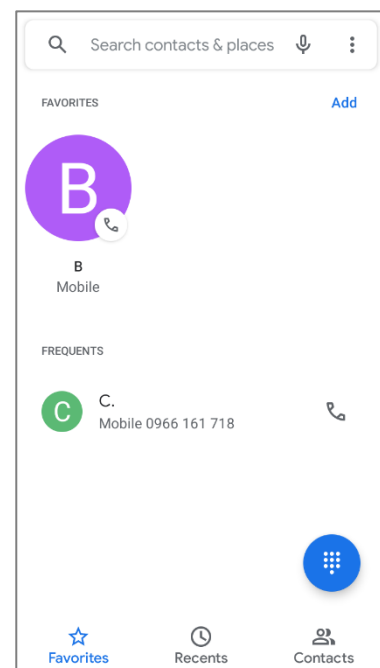

- 3) Return to **"Favorite"** ☆ tab pages, the contact you just marked as favorite is now displayed on **"Favorite"** ☆ tab pages.



5.2.2. PLACE CALL

Enter the phone number in the dial pad and tap  to initiate the call. If you need to frequently make calls to an interactive voice system, you may tap  next to the number and select **Add 2-sec pause** for soft pause (a pause of 2 seconds to the buttons) or a hard pause (a pause that will wait for your confirmation to send the following digits).

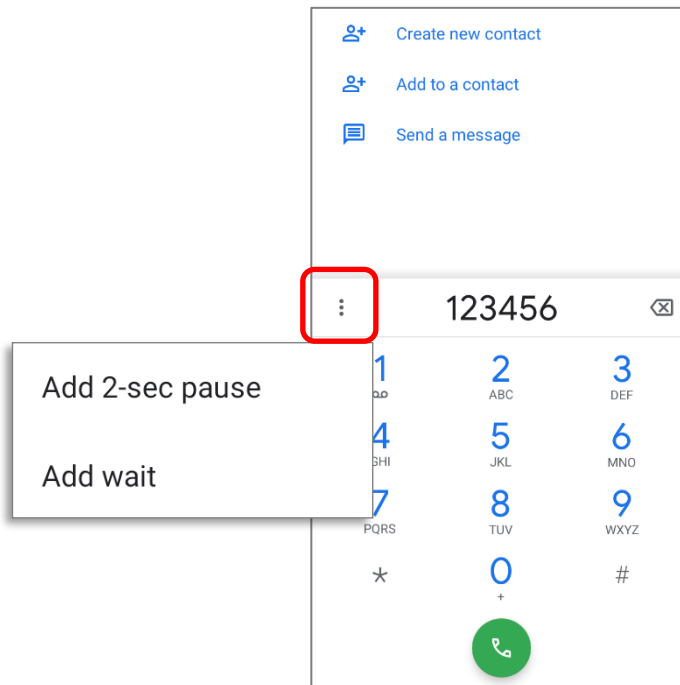

PLACE CALL USING CONTACTS

To make a call using contacts:



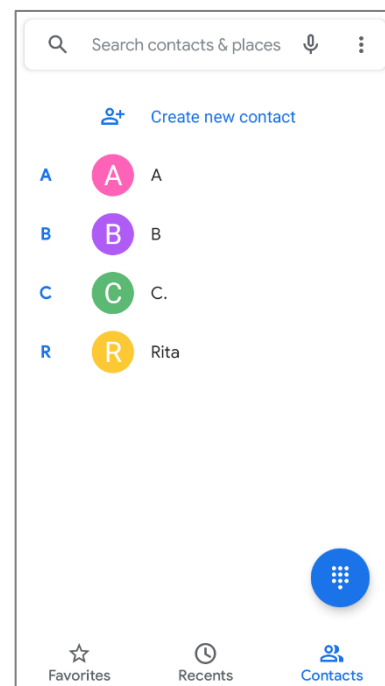



- 1) In the phone application page, tap to enter **"Contact"**  tab page .
- 2) Tap a contact to initiate a call.

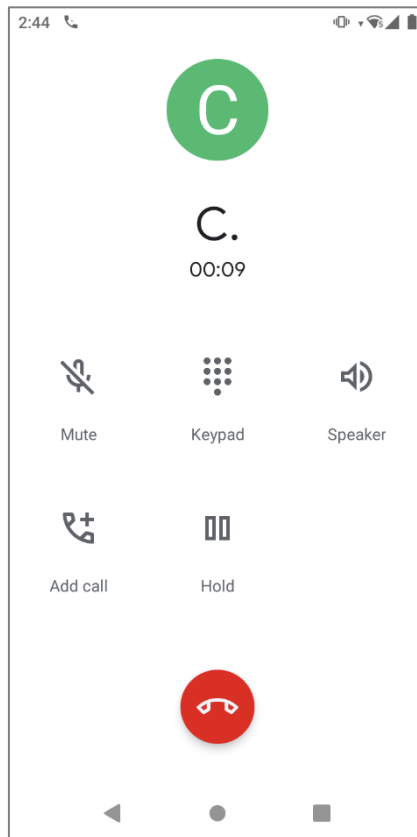

5.2.3. DURING A CALL

When a call is connected, the phone keypad features the following buttons:



Button		Description
	Mute	Mute the call.
	Keypad	Open the numeric keypad.
	Speaker	Turn on the speaker.
	Add call	Add another person to the call.
	Hold	Place the call on hold.
	Hang up	End the call.

5.2.4. RECEIVE INCOMING CALL

When a call is incoming on the mobile computer, tap **Answer** to pick it up.

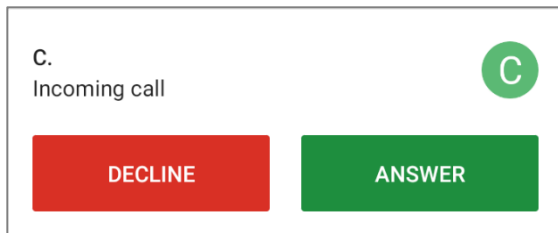



Incoming calls will be logged in the **Phone** application; in the case of a missed call, a notification will be displayed. See [Check Missed Calls](#).

To mute the ringtone of an incoming call, press the volume down button.

5.2.5. CHECK MISSED CALLS

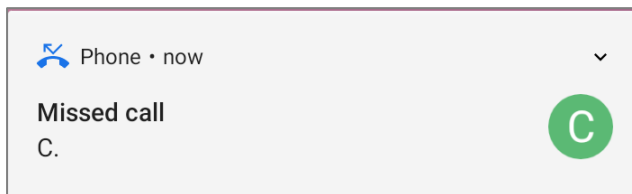
If you have a missed call, a notification icon  will appear on the status bar. The missed calls notification will also be displayed on the lock screen.



(Turning on/off this function on [App Drawer \(All Apps\)](#) | **Settings**  | **Apps & notifications**  | **Notifications** | **Lock Screen**)

Unlock the screen and use the [Notifications Drawer](#) to manage the missed call.

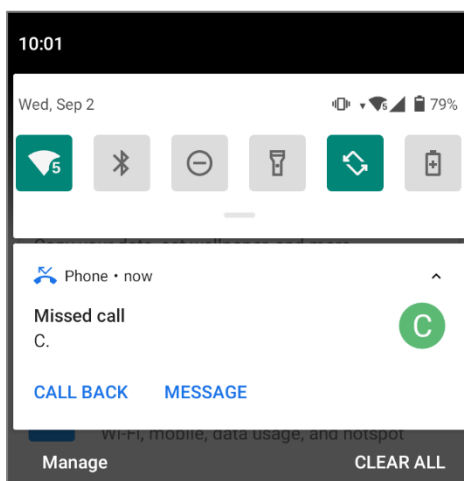

5.2.6. CALL HISTORY



To check the call history:

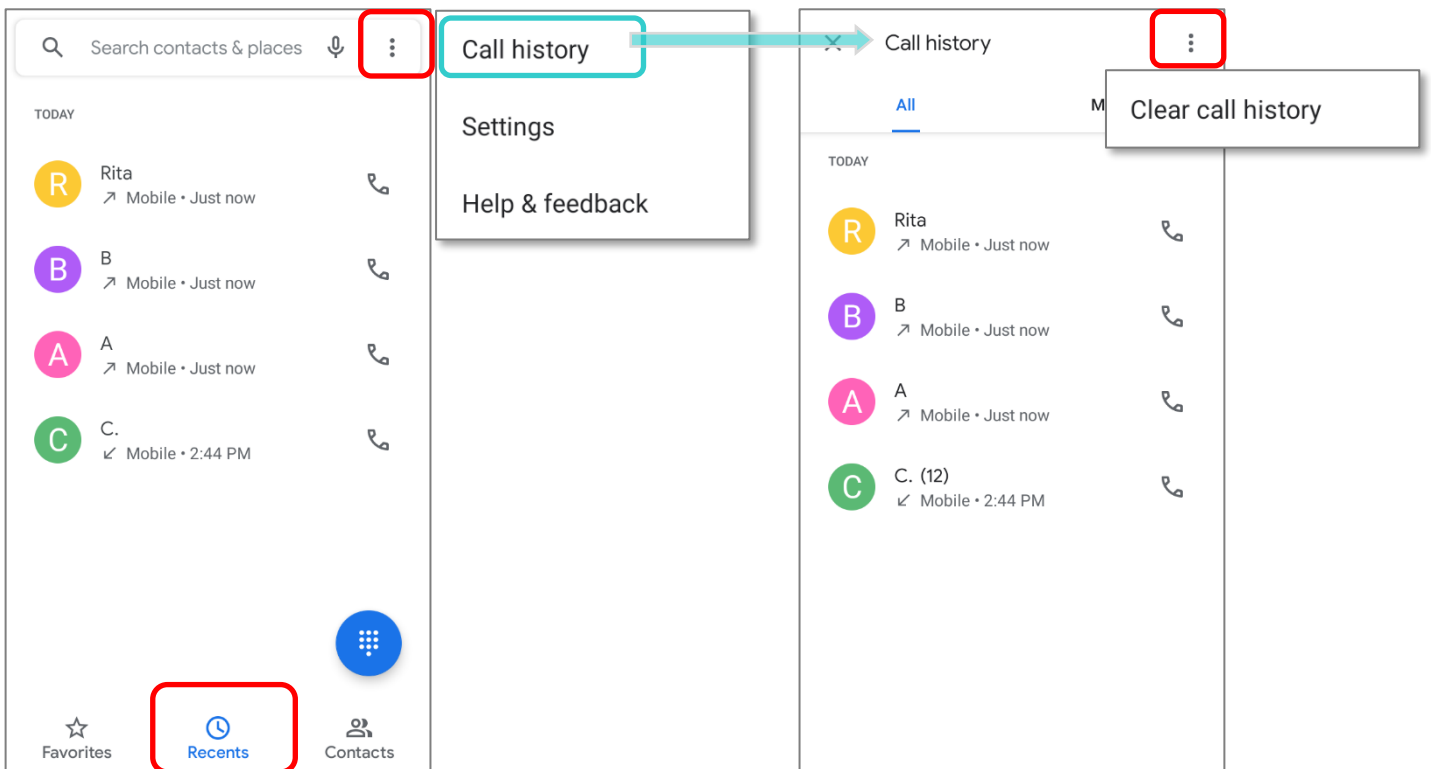

On the Phone application, tap to enter **Recents**  tab page where a list of history calls is displayed.

OR

Tap on the more button  and then **Call history**.



Item	Description
	Connected calls.
	Missed calls.

Tap the phone icon  next to a call record to place back the call. To clear call history, tap on the more button  on **Call history** page and then **Clear call history**.

5.2.7. CALL SETTINGS



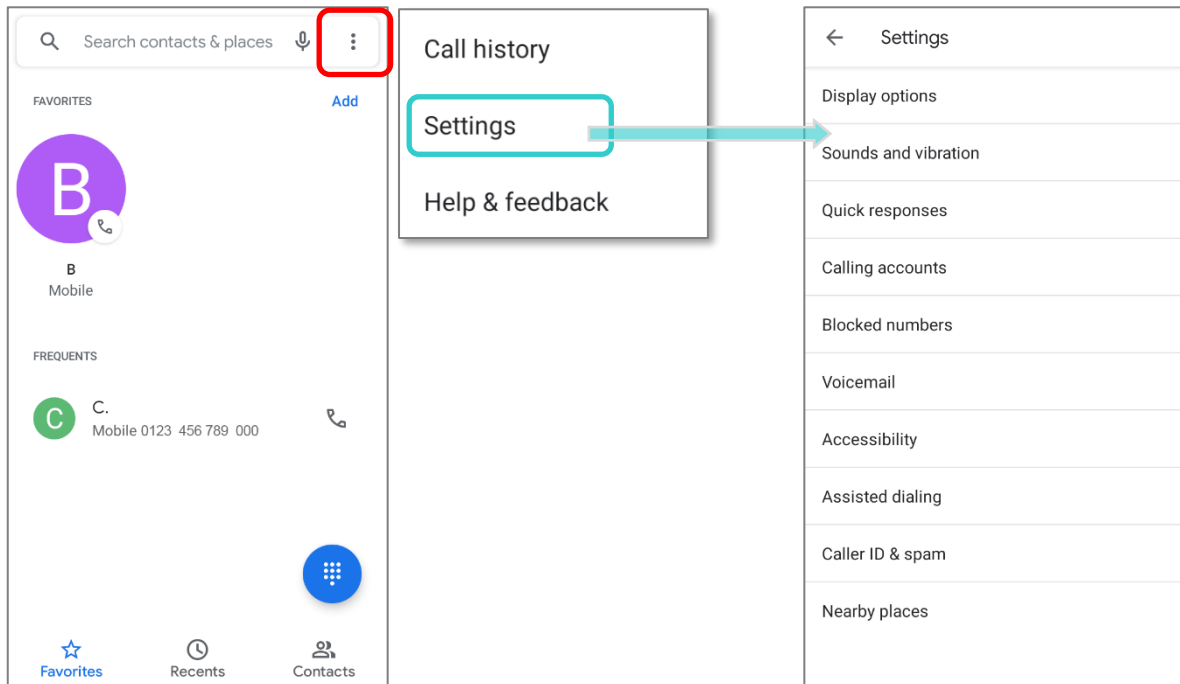







Tap on more button  and select **Settings** to enter the settings page:



Tap on each setting for more setting options.

5.2.8. MAKE MULTI-PARTY CALLS

To make multi-party conference calls:

- 1) On the Phone application page, enter the 1st number to call and tap  to initiate the call.
- 2) After the call has begun, tap **Add call**  to add another member. The 1st call will be put on hold.
- 3) Select the 2nd member from call log or contacts to call directly, or tap the dial pad  to input the phone number to call and tap  to initiate the call.
- 4) When the 2nd call is connected, the first call will continue to be on hold. Tap the merge call button  to add the 1st call to the conversation. A three-party conference call is initiated.
 - ▶ To add a 4th member, please tap . The three-party call will be put on hold. Follow the step similar to step 3 to initiate the call. When the call is connected, the three-party call will continue to be on hold. Tap the merge call button  to add the three-party call to the conversation. A four-party conference call is then initiated.
 - ▶ Tap **Manage Conference Call** to view all members of the call.
 - ▶ To remove a member, tap  next to the member.
 - ▶ To speak with a member in private, tap  next to the member, and the conference call will be put on hold. Tap  to return back to the conference call.

5.3. AUDIO MODES

The mobile computer offers three different audio modes for phone calls:

HANDSET MODE

This is the default audio mode which uses the receiver above the touchscreen for audio output during calls.

SPEAKER MODE

This mode uses the built-in speaker for audio output during calls.

HEADSET MODE

Connect a Bluetooth headset or a wired headset to the mobile computer for audio output during calls.

USE BLUETOOTH HEADSET

See [Pair Bluetooth Devices](#) to connect the mobile computer to a Bluetooth device. The speaker phone becomes muted when a Bluetooth headset is connected.

USE WIRED HEADSET

The RS35 mobile computer supports USB Type-C audio adapter for connecting headsets. Please insert a USB Type-C audio adapter into the USB-C port and then connect with a wired headset. The speaker phone becomes muted when a wired headset is connected.

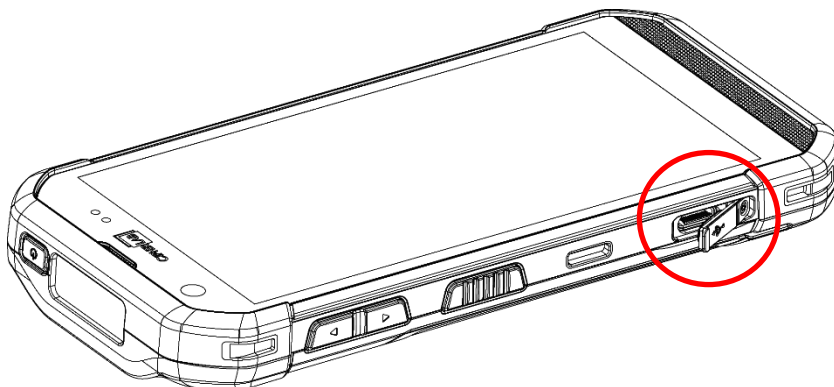

5.4. IN-CALL VOLUME

Use the Volume Buttons to adjust the ringer volume and system sound level. When in the middle of a call, use the volume buttons to adjust in-call conversation volume.

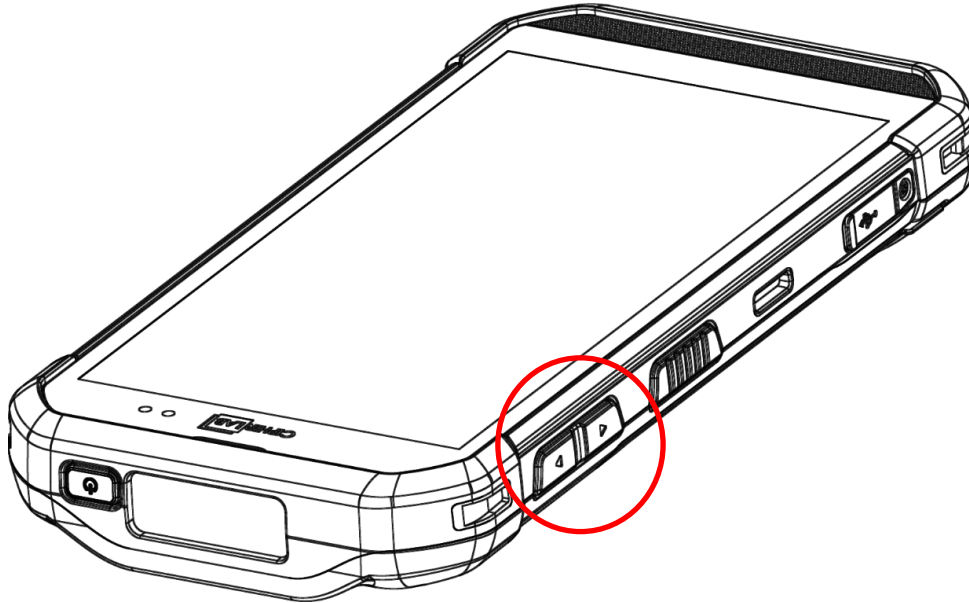

Chapter 6

USING READER CONFIGURATION UTILITY

The **Reader Configuration** utility allows you to manage the barcode reader integrated on the mobile computer.

IN THIS CHAPTER

6.1 ReaderConfig Profile Managment	156
6.2 Configuring Reader	166
6.3 Read Printed Barcodes	195

6.1. READERCONFIG PROFILE MANAGEMENT

The mobile computer is capable of reading printed barcodes. The reader module is 2D imager. The mobile computer is installed with a **ReaderConfig** to configure the scan engine built inside. Use it to create a profile of settings that best suits your needs.

LAUNCH READERCONFIG

To launch **ReaderConfig**, please go to [App Drawer \(All Apps\)](#) | **ReaderConfig**  to open the reader configuration utility.

The main screen of **ReaderConfig** consists of main menu and a list of profiles, including a “**Default**” profile which cannot be deleted. Next to each profile, there is also a profile menu which includes a set of operations that are specific to the profile.

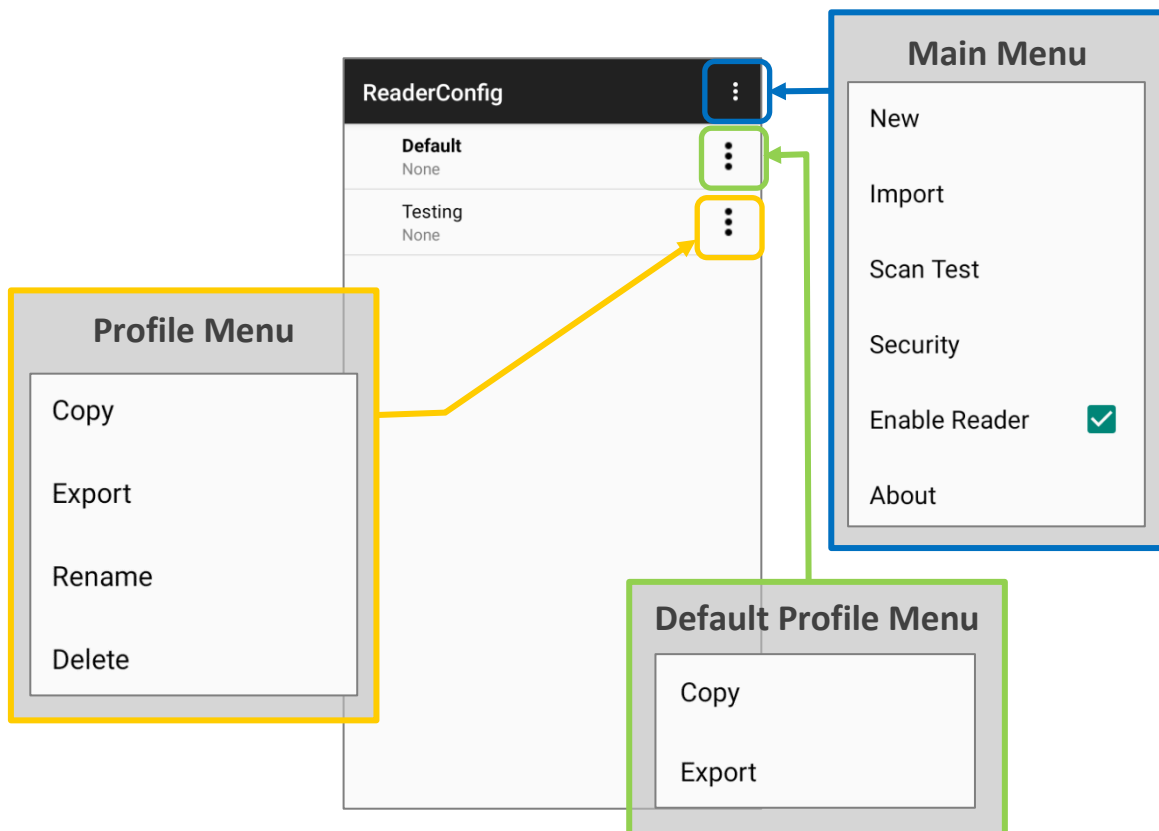

Note:

The “Default” profile is always enabled. Please refer to “[Profile](#)” for how to enable a profile.

6.1.1. READERCONFIG MAIN MENU

ReaderConfig provides an main menu which is accessible on the action bar of the main screen. This menu allows you to create new profiles, import profile(s) in a re-usable format, test scan barcodes, set a password for certain configurations of ReaderConfig, and view copyright and version information.

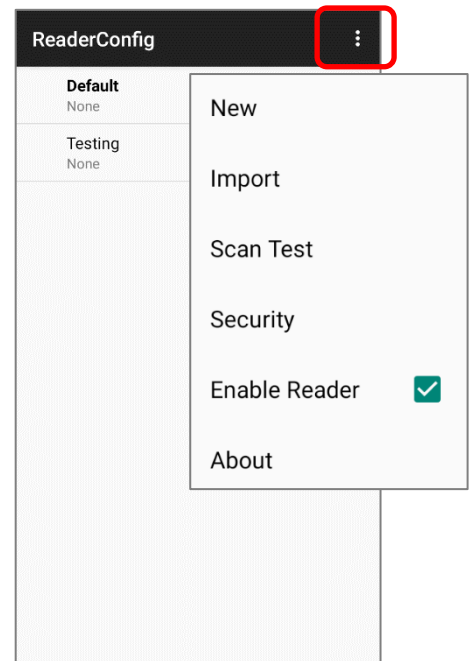

NEW

To create a new profile, please:

- 1) Tap the more button  on the action bar to display the main menu.
- 2) Tap **"New"** and enter a name for new profile in the pop-up dialog. Tap **"OK"** to create the profile.

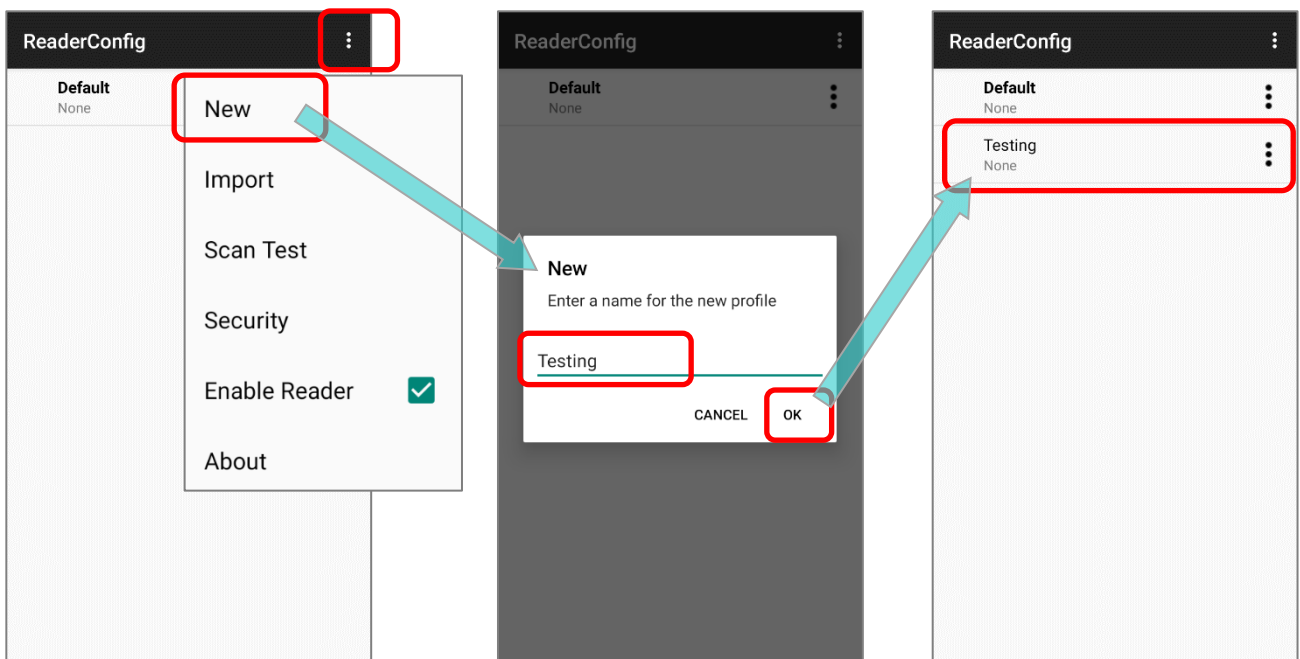

IMPORT

ReaderConfig supports saving the profile settings and exporting them as a *.json* file.

Previously exported profile(s) can be imported again on the mobile computer. This can also be used to implement identical ReaderConfig settings on multiple devices.

To import settings:

- 1) Open **ReaderConfig** as described in [Launch ReaderConfig](#).
- 2) Tap the more button  on the action bar to open the main menu.
- 3) Tap **Import** in the option menu.

A page opens allowing you to select a previously saved profile.

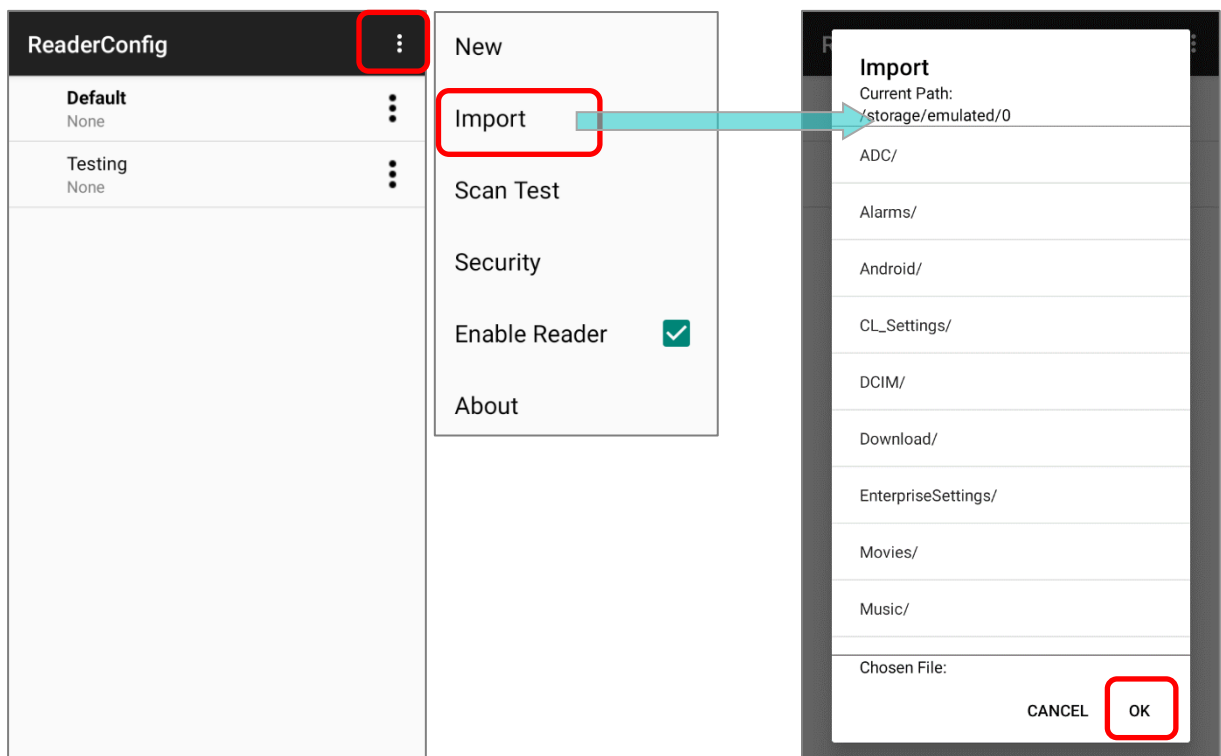

- 4) Tap **OK**. In a few seconds a prompt will appear on the mobile computer to indicate settings have been imported successfully.

Note:

As to exporting a profile, please refer to [“Export”](#) of [“Profile Menu”](#).

When importing a profile that has the same name with an existing profile, a confirmation dialog appears to make sure whether you really want to replace existing profile with the one to be imported.

Tap on **OK** to proceed importing.

ReaderConfig

Do you want to overwrite the duplicate name profile?

CANCEL OK

SCAN TEST

To test scan a barcode:

- 1) Open **ReaderConfig** as described in [Launch ReaderConfig](#).
- 2) Tap the more button  on the action bar to open the option menu.
- 3) Tap **Scan Test** in the main menu. A page opens for test scanning.

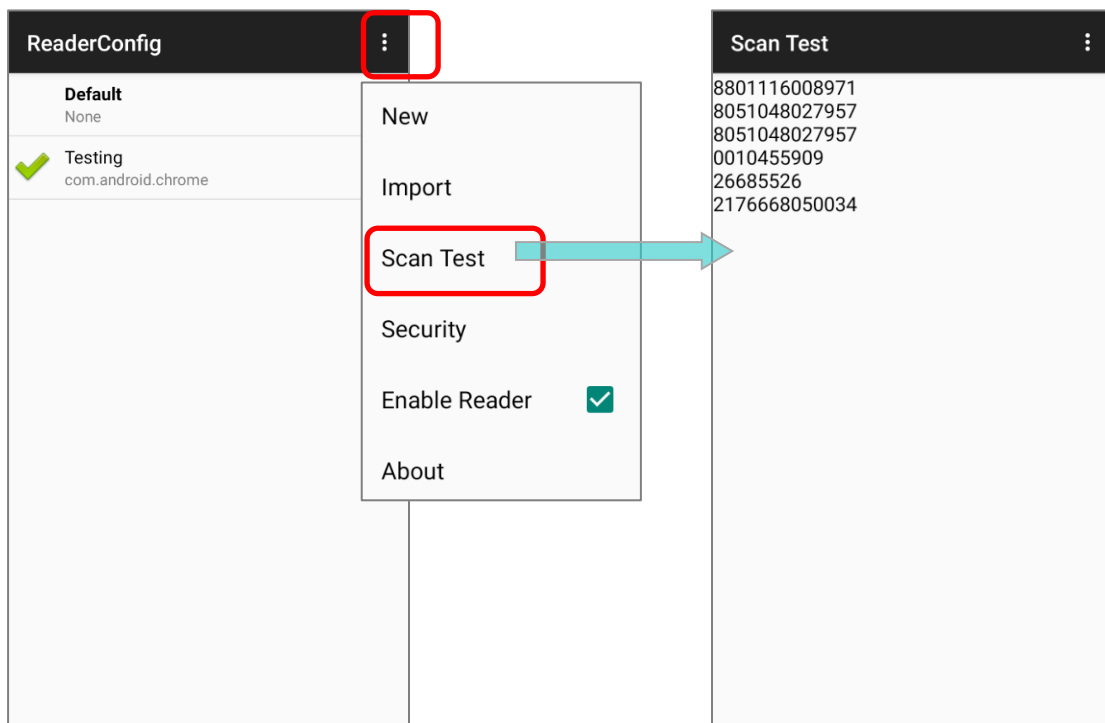

SECURITY

You can set a password to restrict other users of this mobile computer from changing certain configurations or accessing certain functions in ReaderConfig.

- 1) Open **ReaderConfig** as described in [Launch ReaderConfig](#).
- 2) Tap the more button  on the action bar to open the option menu.
- 3) Tap **Security**.
- 4) Enter and confirm a password
(up to 32 characters, containing at least 1 digit or 1 alphabetic letter).
- 5) Check the items that will be protected by this password.

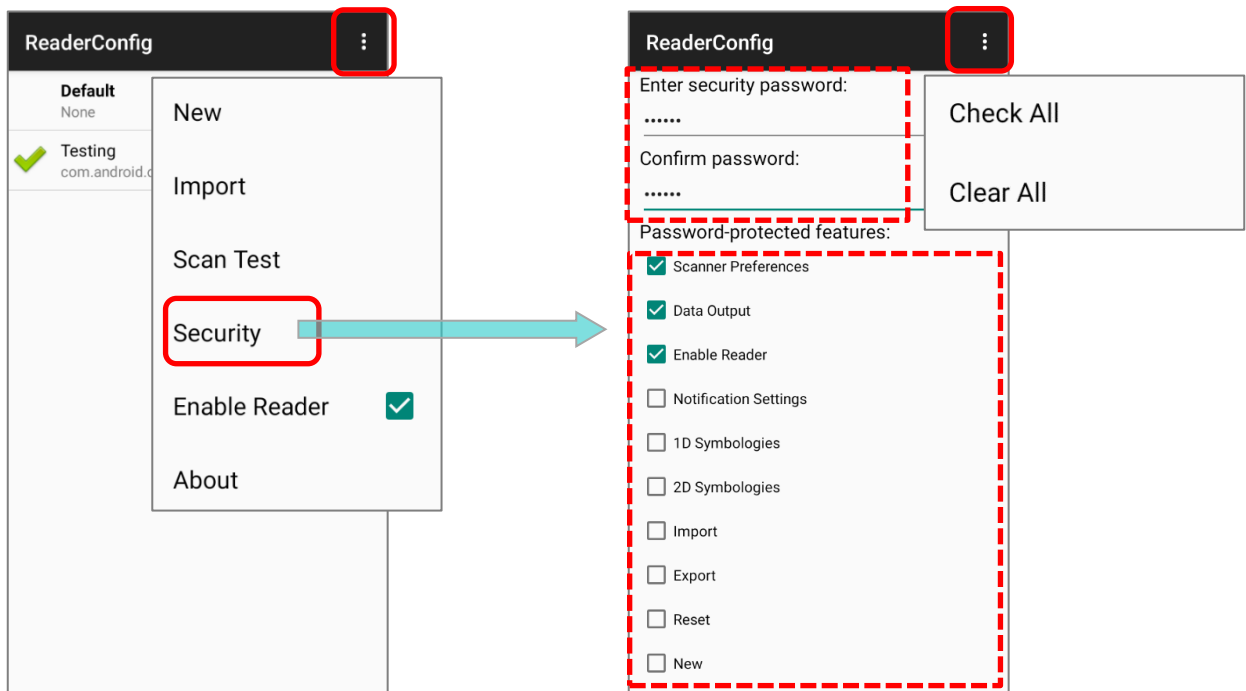

Once security password is enabled, "**Security**" and the password-protected features become unavailable after logging out. User needs to enter the password to login to perform the function(s) locked by the password.

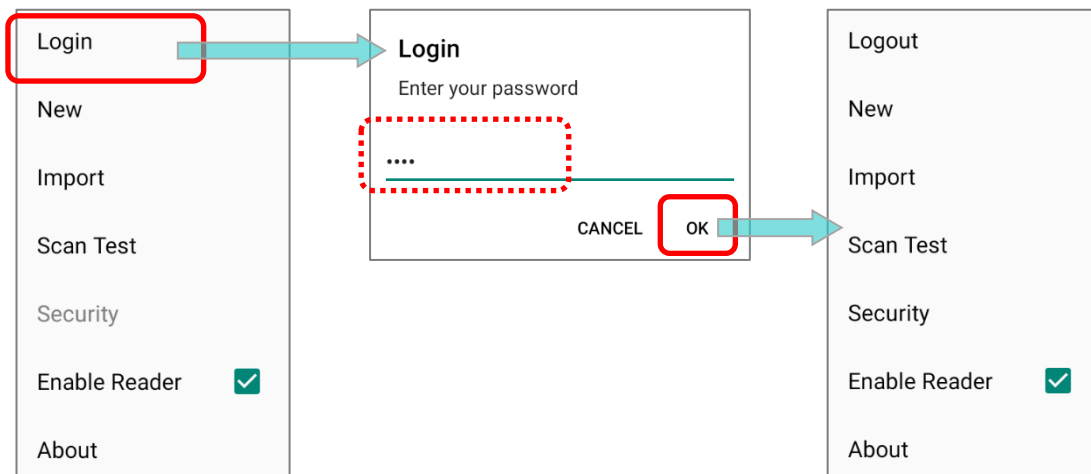

ENABLE READER

Tick or untick the checkbox to enable or disable reader scanning ability. When enabled, a light beam will be sent out from the scanning window each time the trigger (scan key) is pressed.

By default, the reader is enabled.

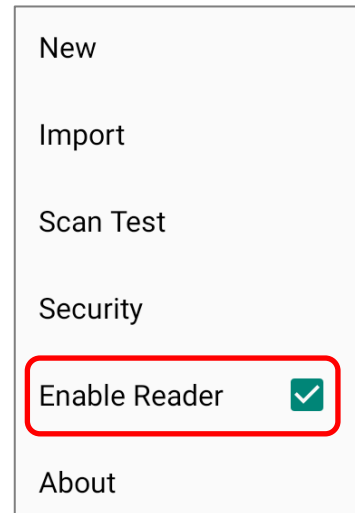

ABOUT

Tap **About** in the **ReaderConfig** main menu to display software version and copyright information.

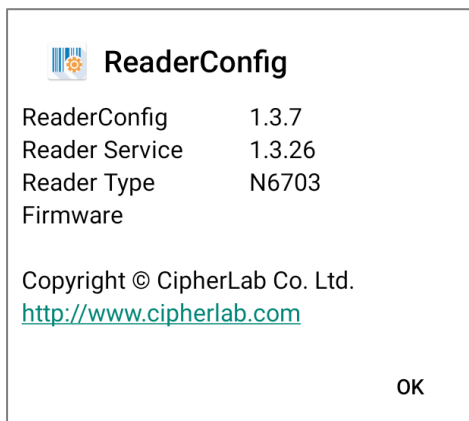

6.1.2. PROFILE MENU

Tap more button  on the right of the profile to display the profile menu. The profile menu contains options that are specific to the profile. The options are described in the followings sections:

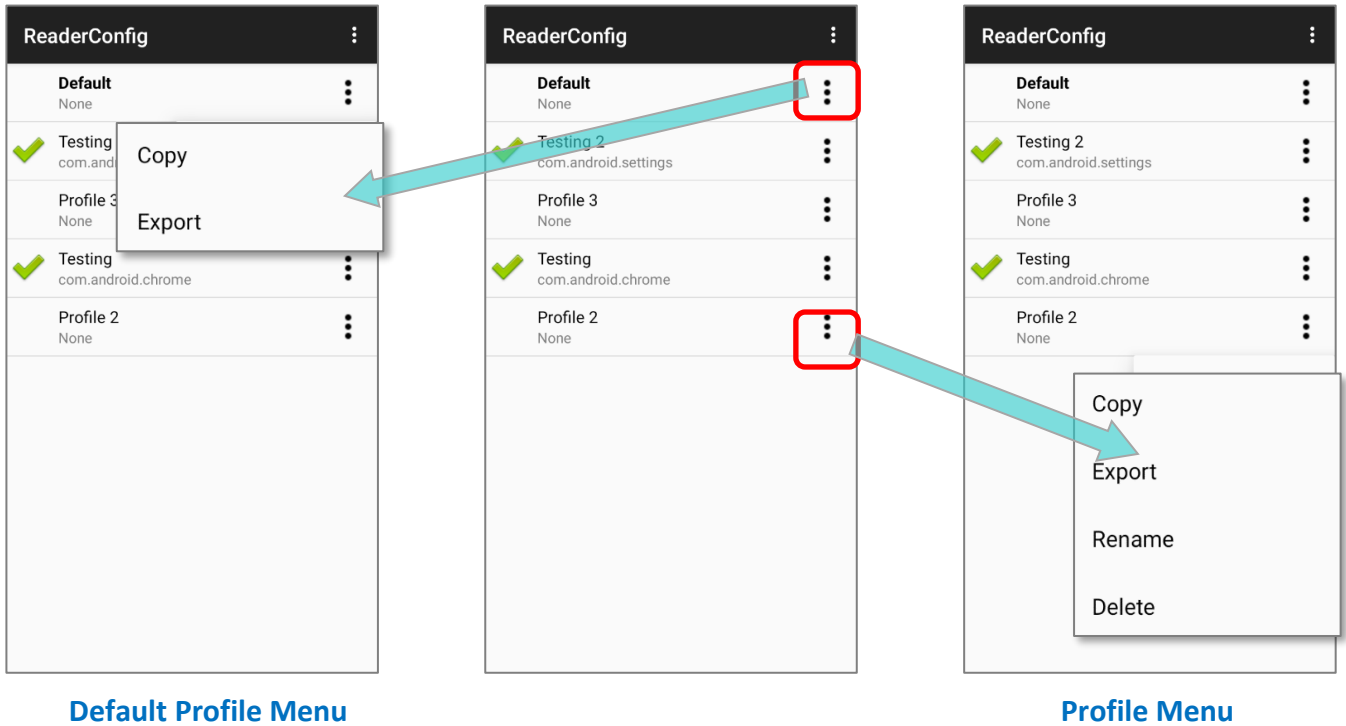

COPY

You can copy an existing profile and make changes from it. To copy a profile:

- 1) Tap the more button  next to the profile you would like to copy, and select "Copy" from its profile menu.

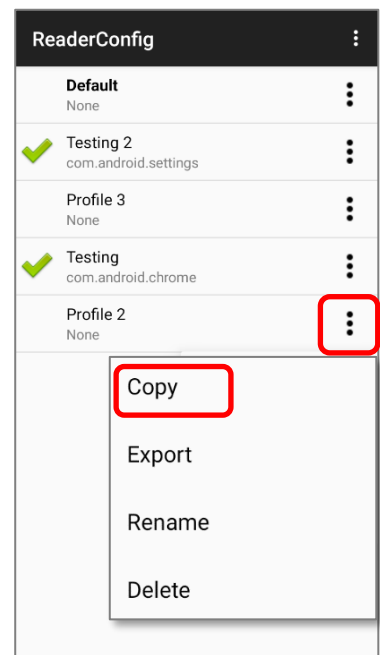

2) Enter a name for the new profile and press the "OK" button to make a copy.

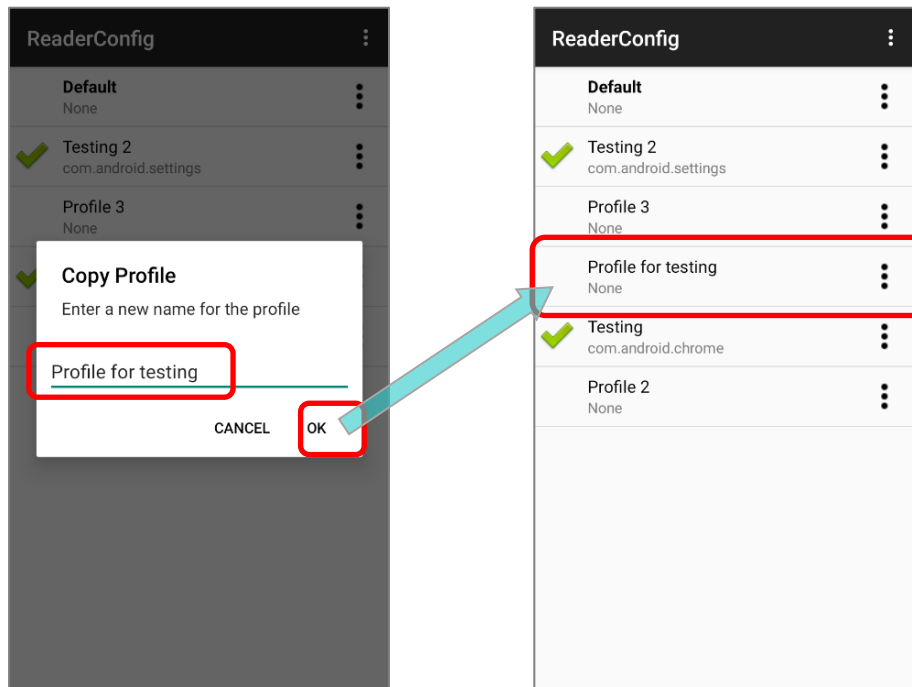

Note: An app can be set as the [associated app](#) to only one profile. Thus, [the "Profile" part](#) will not be duplicated when copying a profile.

EXPORT

To export a profile, tap the more button  next to the profile that you would like to export and select **Export**. An export page opens allowing you to enter the name and location of the profile to save.

Tap **OK** to export. A prompt will appear on-screen to notify that settings have been exported.

Default Profile Menu

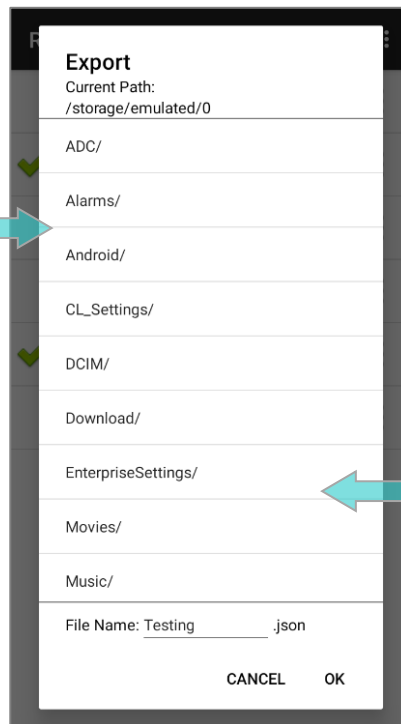
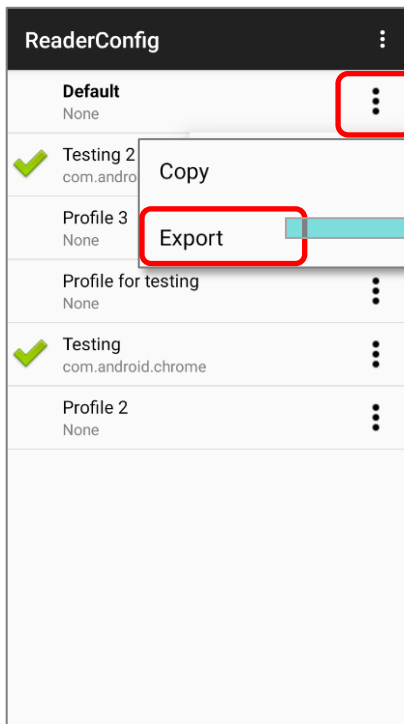

Profile Menu

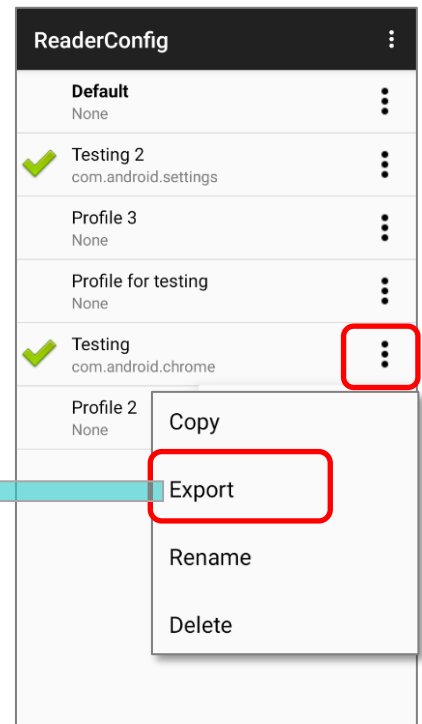

Note: The exporting profiles will be saved as a .json file.

RENAME

To rename an existing profile, simply tap on the more button  next to the profile you'd like to rename and select **"Rename"**. Then, enter a new name for the profile. Finally, tap **"OK"** button to change its name.

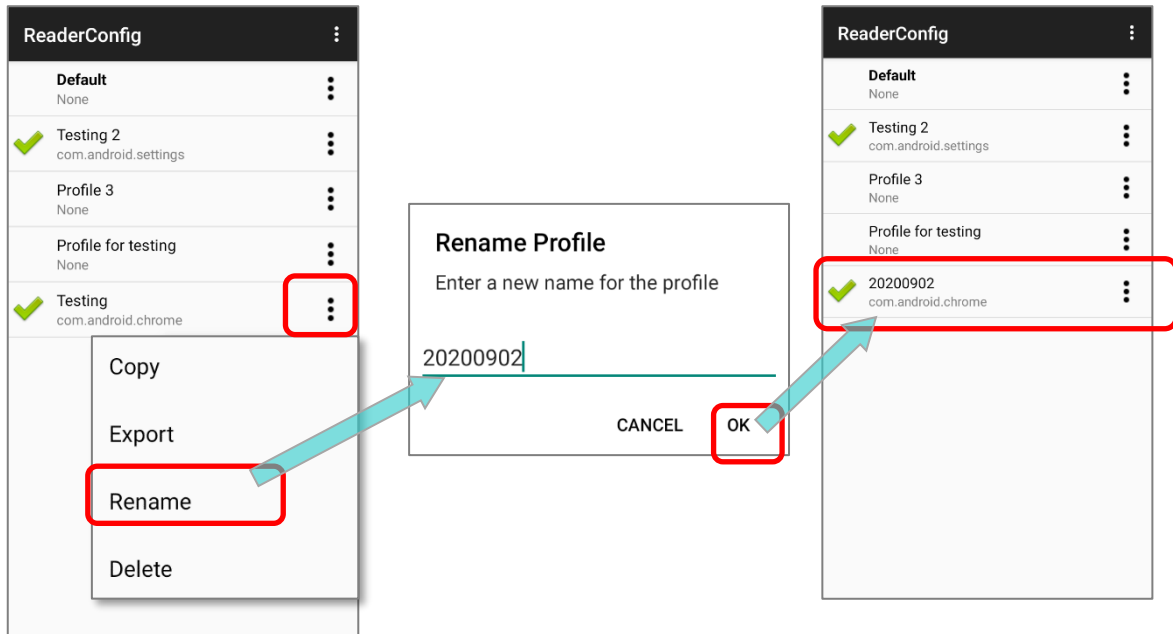

DELETE

To delete a profile, simply tap on the more button  next to the profile you would like to delete and select **"Delete"**. Tap **"OK"** on the confirmation dialog to delete the profile.

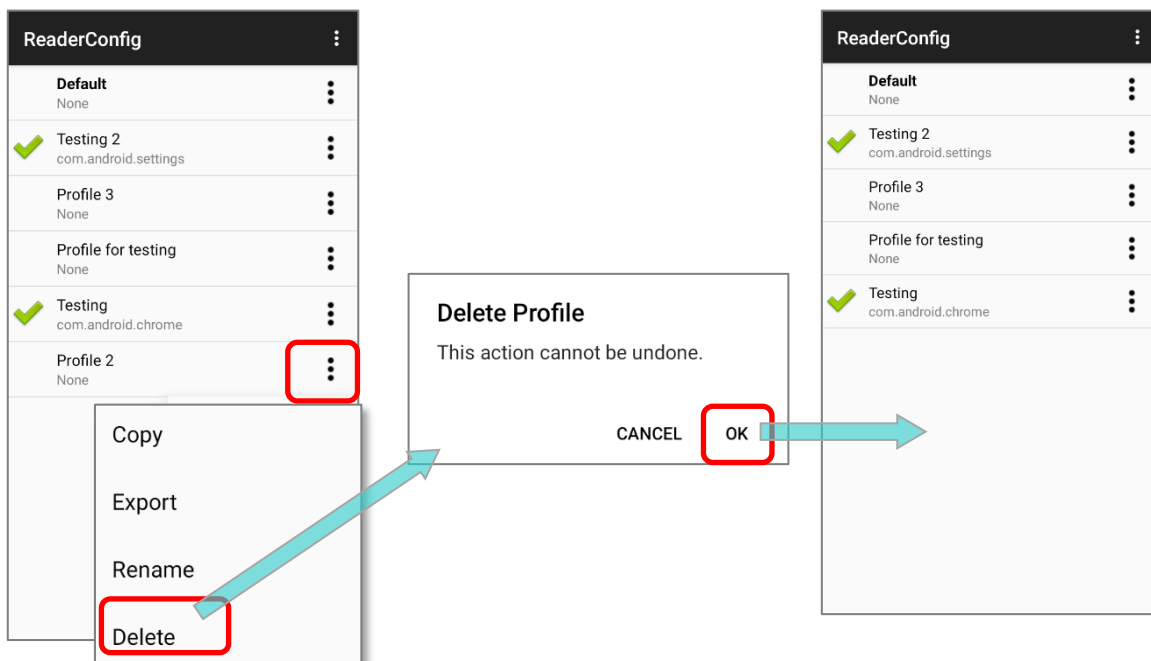

6.2. CONFIGURING READER

Tap on a profile to enter the profile main page for further settings.

Default Profile Main Setting Page

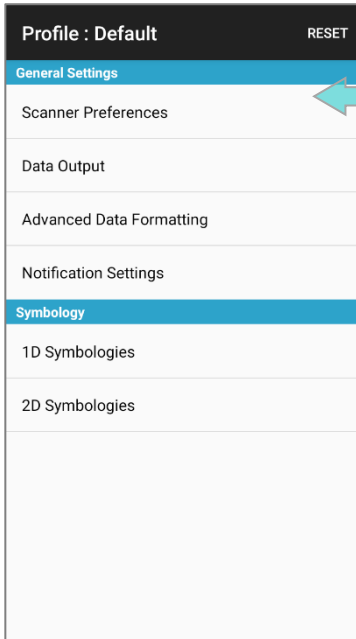

ReaderConfig Main Screen

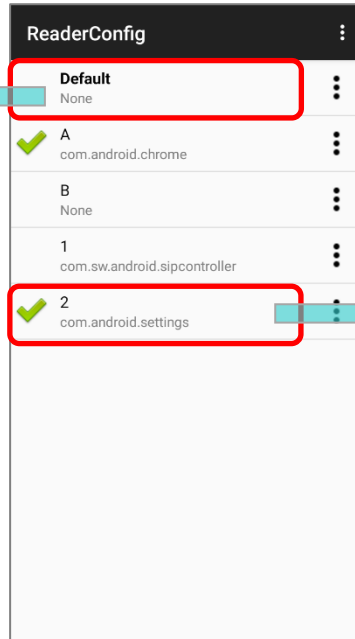

Profile Main Setting Page

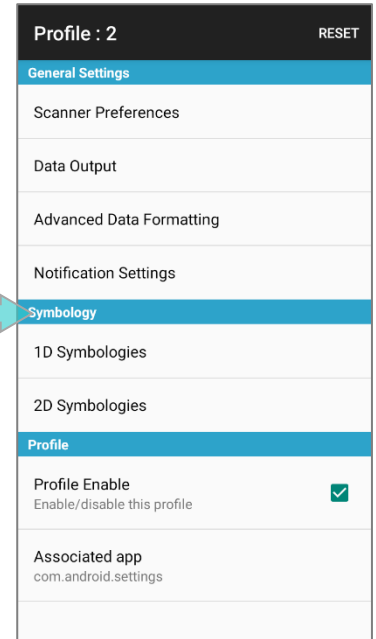

ReaderConfig launches in context with the reader module(s) on board the mobile computer. On the profile main settings page are three sections: **General Settings**, **Symbology** and **Profile**.

6.2.1. GENERAL SETTINGS

General Settings is where all reader settings are accessed from. Tap each item to enter its sub-menu.

The functions under **General Settings** include:

- ▶ Scanner Preferences
- ▶ Data Output
- ▶ Advanced Data Formatting
- ▶ Notification Settings

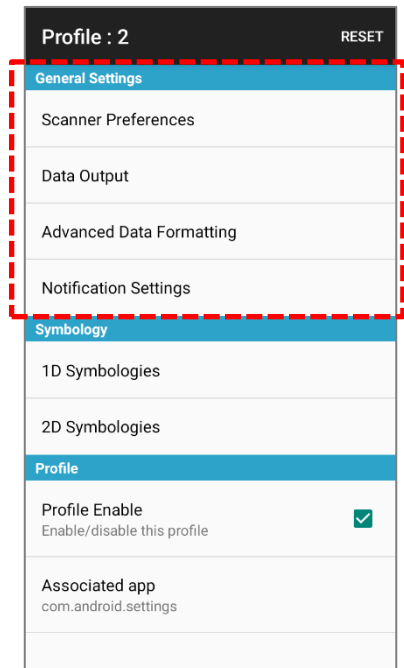

SCANNER PREFERENCES

Options on the **Scanner Preferences** page differ according to the type of scan engine built within the mobile computer.

Simply tap on **Scanner Preferences** to open **Scanner Preferences** page:

Scanner Preferences	
Decode Timeout	3 seconds
Redundancy Level	Level 1
Security Level	Level 0
Inter-Char Gap Size	Normal
Scan Mode	Level Mode
Aim Timeout	3 seconds
Decoding Illumination	<input checked="" type="checkbox"/>
Decode Aiming Pattern	<input checked="" type="checkbox"/>
Picklist Mode	<input type="checkbox"/>

2D IMAGER SETTINGS

Setting	Description	Default										
Decode Timeout	Sets the maximum time for the decoding process during a scan. Configurable between 1 sec to 9 sec.	3 sec.										
Redundancy Level	Sets how many successful readings should be done before linear barcodes such as Codabar, MSI, and Interleaved 2 of 5 can be decoded. Levels 1 to 4 available.	Level 1										
Security Level	<p>Sets the security level to ensure decoding accuracy considering the printed quality of barcodes such as Code 128, Code 93, and UPC/EAN. The higher the level is, the more security is ensured. Options are:</p> <table border="1"> <thead> <tr> <th>Level</th> <th>Description</th> </tr> </thead> <tbody> <tr> <td>0</td> <td>With this default, the scan engine is aggressive enough to decode most “in-spec” barcodes.</td> </tr> <tr> <td>1</td> <td>Select this level if misdecodes have occurred. It fixes most misdecodes.</td> </tr> <tr> <td>2</td> <td>Select this level if Level 1 should fail to eliminate misdecodes.</td> </tr> <tr> <td>3</td> <td>Select this level if Security Level 2 should fail to prevent misdecodes. However, as this level actually impairs the decoding ability of the decoder, a safer solution would be to improve the quality of the bar codes to read.</td> </tr> </tbody> </table>	Level	Description	0	With this default, the scan engine is aggressive enough to decode most “in-spec” barcodes.	1	Select this level if misdecodes have occurred. It fixes most misdecodes.	2	Select this level if Level 1 should fail to eliminate misdecodes.	3	Select this level if Security Level 2 should fail to prevent misdecodes. However, as this level actually impairs the decoding ability of the decoder, a safer solution would be to improve the quality of the bar codes to read.	Level 0
Level	Description											
0	With this default, the scan engine is aggressive enough to decode most “in-spec” barcodes.											
1	Select this level if misdecodes have occurred. It fixes most misdecodes.											
2	Select this level if Level 1 should fail to eliminate misdecodes.											
3	Select this level if Security Level 2 should fail to prevent misdecodes. However, as this level actually impairs the decoding ability of the decoder, a safer solution would be to improve the quality of the bar codes to read.											

Setting	Description	Default
Inter-Char Gap Size	Sets the intercharacter gap size for Code 39 and Codabar. This option is to allow the digital scanner to adjust its decoding standard so as to tolerate out-of-specification bar codes that are improperly printed out (which may cause the intercharacter size to become larger). Switch between Normal and Large .	Normal
Scan Mode	<p>Sets the reader's scanning behavior.</p> <p>Level Mode: The decoding process is activated by a trigger event, and continues until the trigger event ends, a valid decode happens or decode session time-out is reached.</p> <p>Release Scan Mode: Keep pressing the scan key to project the aiming pattern, and the decoding process is not triggered till the scan key is released.</p> <p>Aimer Mode: Press the scan key once to project the aiming pattern, and then press the scan key again (before the aiming pattern fades) to trigger the decoding process.</p> <p>Level and Aim Mode: Press the scan key once to project the aiming pattern and then press again to decode. The aiming pattern remains after successfully decoding, and the reader is ready to decode by pressing the scan key again.</p>	Level Mode
Aimer Mode Timeout	A time period that the aiming pattern is projected for Aimer Mode . This function is only available when setting Scan Mode as Aimer Mode or Level and Aim Mode .	3
Decoding Illumination	Enables an LED light beam to aid barcode reading.	Selected (Enabled)
Decode Aiming Pattern	Projects a crosshair at the center of the laser light beam to facilitate barcode reading.	Selected (Enabled)
Picklist Mode	When selected, only barcodes aligned at the crosshair of the laser light beam will be decoded.	Deselected (Disabled)
Display Mode	Enable improved performance for reading barcodes on electronic displays and mobile phones.	Deselected (Disabled)
Inverse Type	Decide whether to disable or enable decoding inverse barcodes, or set as auto.	Regular only
Addon Redundancy	Functions when "auto-discriminate" is applied for UPC/EAN addons. Decides the number of times of supplemental decoding of the same barcode in order to count as a valid read. Configurable between 2 and 30.	10

Setting	Description	Default
Illumination Power Level	Users can adjust the illumination brightness of the LED light source. Move the slider to specify a value ranging from 1 to 10 to set the brightness level which is set to 10 by default meaning 100% illuminated.	10
Transmit AIM Code ID	Sets whether to include AIM code ID character in the decoded data. For AIM code ID, see the following: Code 128 Emulation of 2D Imager Symbology Settings.	Deselected (Disabled)

DATA OUTPUT

Data Output allows users to set the way to output decoded data.

Data Output	
Keyboard Emulation	Input Method
Intent Action	
Intent Decode Data	
Auto Enter	Decoded data + Enter char
Auto Enter Character	Carriage return
Display Code Type	<input type="checkbox"/>
Display Code Length	<input type="checkbox"/>
Prefix	
Suffix	
Field Delimiter	

Data Output	
Decoded data + Enter char	
Auto Enter Character	Carriage return
Display Code Type	<input type="checkbox"/>
Display Code Length	<input type="checkbox"/>
Prefix	
Suffix	
Field Delimiter	None
Barcode Charset	UTF-8
Clear Previous Data	<input type="checkbox"/>
Key Event Delay Time	0 ms

DATA OUTPUT METHOD

Keyboard Emulation setting controls in which way the data is sent. Tap the switch to enable. When enabled, the reader module treats decoded data as typed text and outputs it to the active application on the mobile computer. The default setting is **"Input Method"**, and the options are:

Item	Descriptions
None	<p>Disables keyboard emulation. The decoded data will be sent by the broadcast intent message.</p> <p>By selecting “None”, you can further set the followings:</p> <ul style="list-style-type: none"> ▶ Intent Action: Specify the intent name according to the application which will receive the decode intent. ▶ Intent Decode Data: Define the intent data name according to the application which will receive the decode intent.
Input Method	Allows the active application to receive characters or symbols that can be input by the input method.
Key Event	Allows the active application to receive characters or symbols that can be input by key events.
Copy & Paste	Copy the decoded data and paste it to the active application.

HOW TO OUTPUT

After determining the keyboard emulation type, please configure how to output decoded data, i.e. the “format” to present decoded data.

Setting	Description	Default
Timeout between Input Method	To specify the pause time between data to be transmitted. The function is only when “ Keyboard Emulation ” is set to be “ Input Method ”.	0
Auto Enter	<p>Adds an ENTER character before or after each string of decoded data. The ENTER character can be defined in the “Auto Enter character” field below. This function saves the trouble of pressing a confirmation key to accept each string of decoded data. Options are:</p> <ul style="list-style-type: none"> ▶ Disable ▶ Decoded data + Enter char ▶ Enter char + Decoded data 	Decoded data + Enter char

Setting	Description	Default
Auto Enter character	<p>Adds a key code before or after the decoded data. If [Auto Enter] is enabled, select the ENTER character to send. Options are:</p> <ul style="list-style-type: none"> ▶ None ▶ Carriage Return ▶ Tab ▶ Space ▶ Comma ▶ Semicolon 	Carriage Return
Display Code Type	Prefixes the output data with code type information.	Deselected (Disabled)
Display Code Length	Suffixes the output data with code length information.	Deselected (Disabled)
Prefix	<p>Affixes 0 to 20 characters to the left of the output data. Tap the label to open a character table for entering the prefix.</p> <p>Prefixes containing invisible characters are supported.</p>	--
Suffix	<p>Affixes 0 to 20 characters to the right of the output data. Tap the label to open a character table for entering the suffix.</p> <p>Suffixes containing invisible characters are supported.</p>	--
Field Delimiter	<p>Sets the delimiter to separate the output barcode data to the following pieces: code type, decoded barcode data, and code length (if applicable). Options are:</p> <ul style="list-style-type: none"> ▶ None ▶ Comma ▶ Semicolon ▶ Full stop 	None
Barcode charset	Specifies the current decoding for barcode data.	UTF-8
Clear Previous Data	By enabling this option, only the last scanned data entry will be output.	Deselected (Disabled)
Key Event Delay Time	Set the millisecond you need to postpone the key event triggered by the decoded data.	0 ms

ADVANCED DATA FORMATTING

Advanced Data Formatting is to customize the decoded data and then output it by rules, and therefore **Advanced Data Formatting** rule(s) needs to be created beforehand. A rule combines “**criteria**” with “**actions**” to be performed. If the decoded data meets the “criteria”, it will be output according to the “actions”.

Please refer to section 6.2.2 “[Advanced Data Formatting](#)” for further description.

NOTIFICATION SETTINGS

Notification Settings enables audible, visible and tactile feedback for scanning good read, which helps notify the user of a successful decoding.

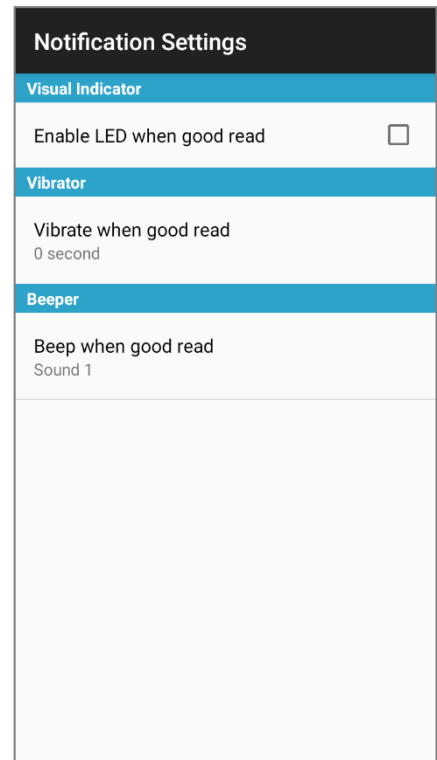

Setting		Description	Default
LED	Enable LED when good read	Selects to enable/disable LED light (left) for scanning good read. See Status LED for details.	Deselected (Disabled)
Vibrator	Vibrate when good read	Enables/disables tactile feedback (vibration) for good read and sets the duration to vibrate.	0 second (Disabled)
Beeper	Beep when good read	Sets the beeper sound for scanning good read. Users can choose to mute the beeper sound, or configure the beeper between sounds 1 to 9.	Sound 1

6.2.2. ADVANCED DATA FORMATTING

User can customize the output data through the defined rules in **“Advanced Data Formatting”**.

CREATE A NEW RULE

Please follow the steps below to create a new rule:

- 1) Launch the app **ReaderConfig** and tap to enter the profile you would like to set.
- 2) Tap on **“Advanced Data Formatting”**.

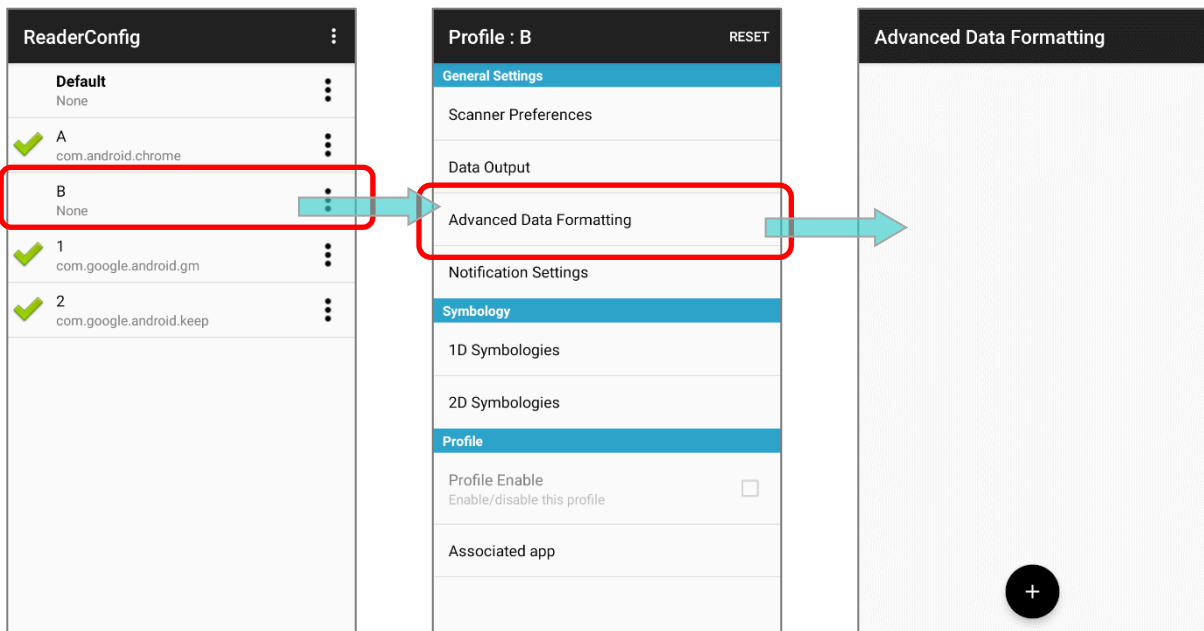

- 3) Tap on the **“Add”** button  and enter the name for this new rule. Create it by tapping on **“OK”**.

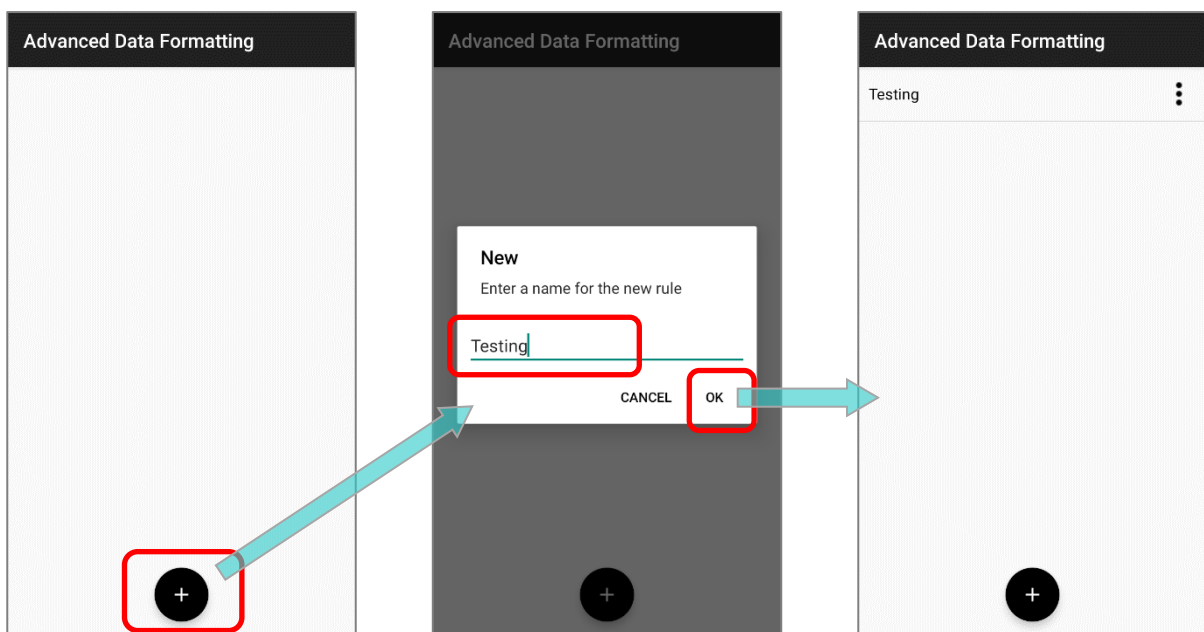

The rule is created, and now you can enter its main page for further settings in "[Criteria](#)" and "[Actions](#)" to specify your customized reformatting instructions.

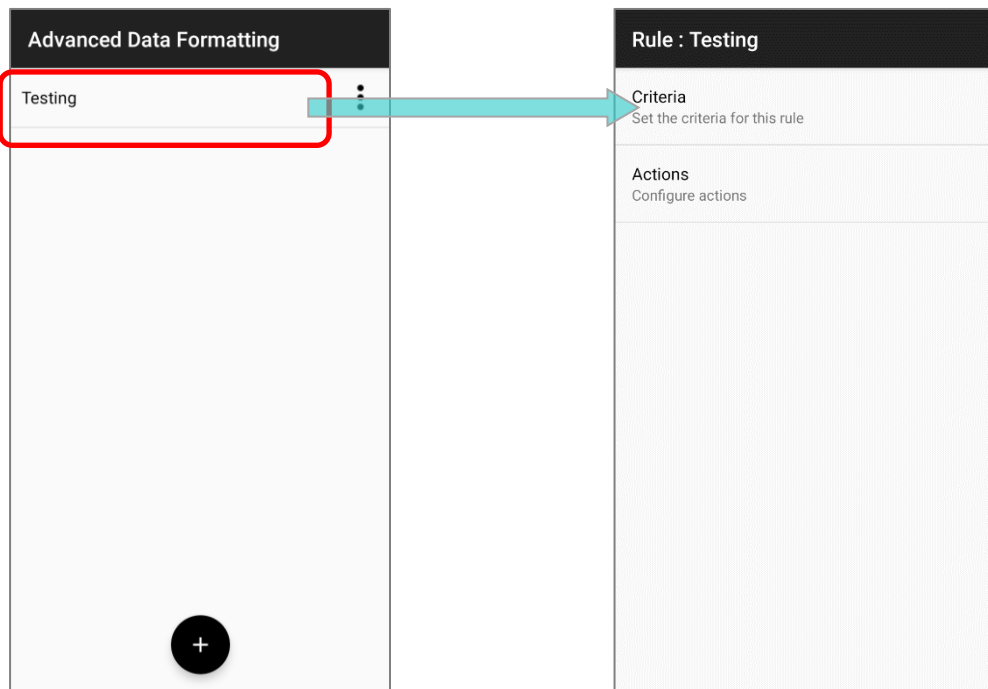

DELETE A RULE

To delete a rule, tap on the more button  next to the rule to be removed and then "**Delete**". Confirm deleting it by tapping on "**OK**".

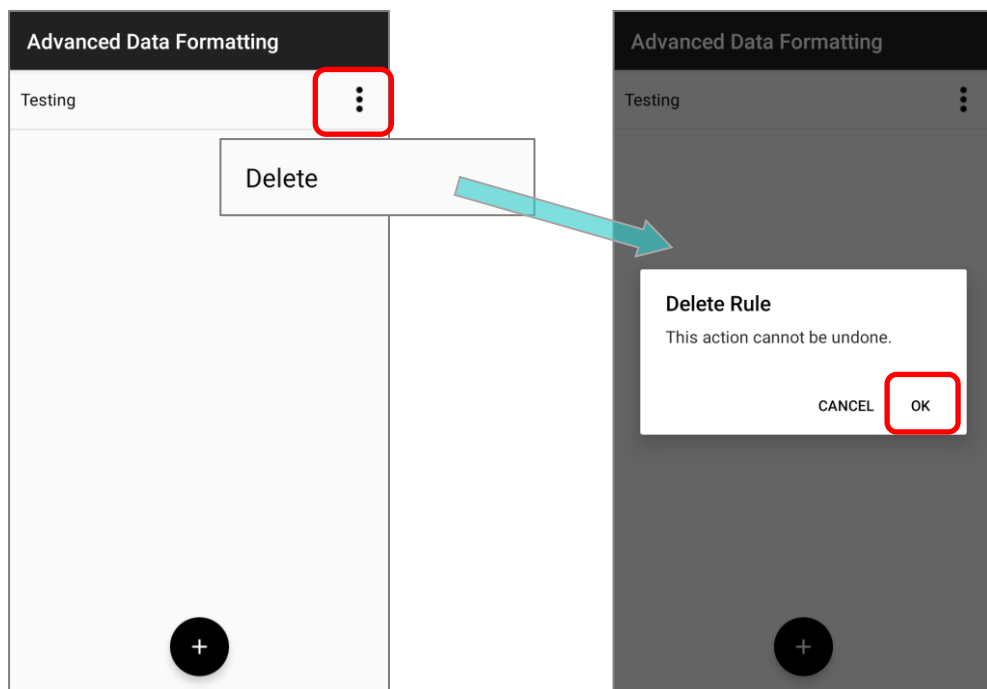

CRITERIA

“**Criteria**” is to set the limits and requirements to filter the decoded data. When the barcode is read and the input data fulfils the “**criteria**”, it will be dealt with by the associated “**actions**” which defines the output data format.

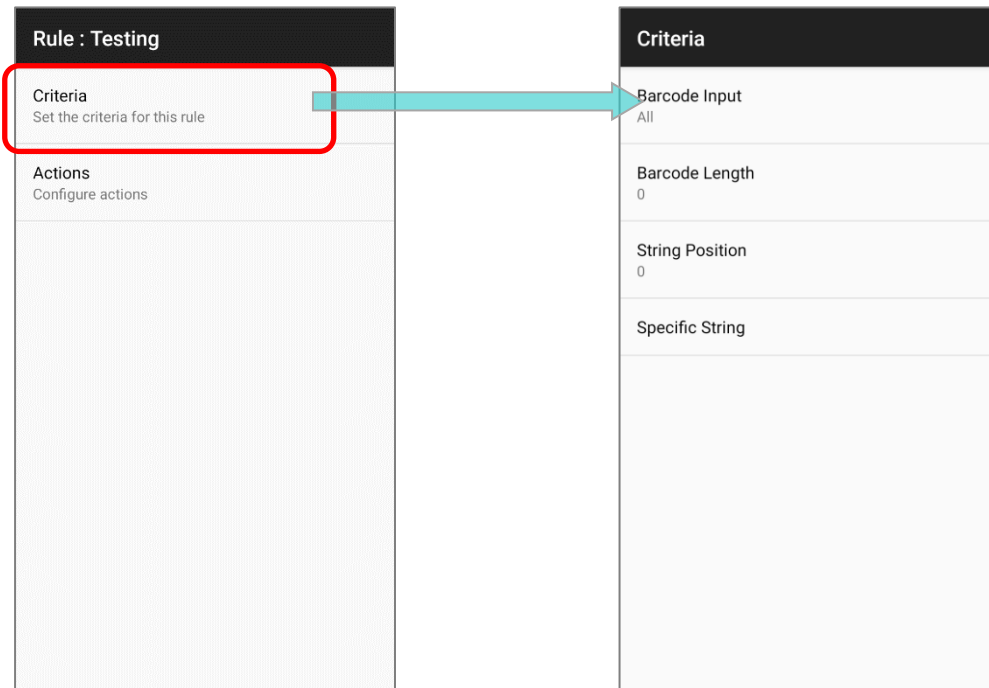

The available criteria to be set are:

Item	Description
Barcode Input	To designate the barcode symbology. By selecting “ All ”, all the barcode symbologies will be reformatted by “ actions ”.
String Length	To set the barcode length to limit the decoded data to be reformatted.
String Position	This function works with “ Specific String ” to designate the particular position this specific string should be in. By selecting “ 0 ”, the specific string can be in any position.
Specific String	To designate the string the decoded data must include.

The decoded data should meet all the criteria you set and then the data will be reformatted by “**actions**” before outputting.

EXAMPLE

The followings are the examples of barcodes to be filtered by criteria:

Barcode	Details
Barcode 1	Symbology: EAN13 Barcode data: 0001112223334 Length: 13
Barcode 2	Symbology: EAN13 Barcode data: 4445556667778 Length: 13
Barcode 3	Symbology: EAN13 Barcode data: 888999000 Length: 9A
Barcode 4	Symbology: Code39 Barcode data: 555522221111 Length: 13

If the criteria are set as:

- 1) **"Barcode Input" is "All":**
Barcode 1 (EAN13), Barcode 2 (EAN13), Barcode 3 (EAN13), and Barcode 4 (Code39) all match the criteria.
- 2) **"Barcode Input" is "EAN13":**
Barcode 1 (EAN13), Barcode 2 (EAN13), and Barcode 3 (EAN13) meet the criteria.
- 3) **"Barcode Input" is "EAN13", and "String Length" is "9":**
Only Barcode 3 (EAN13; length= 9) matches the criteria.
- 4) **"Barcode Input" is "EAN13", and "String Length" is "10":**
None of the barcodes fulfils the criteria.
- 5) **"Barcode Input" is "All", and "String Length" is "13":**
Barcode 1 (EAN13; length= 13), Barcode 2 (EAN13; length= 13), and Barcode 4 (Code39; length= 13) meet the criteria.

6) "Barcode Input" is "All", and "Specific String" is "000":

Barcode 1 (EAN13; 0001112223334) and Barcode 3 (EAN13; 888999000) meet the criteria.

7) "Barcode Input" is "All", and "Specific String" is "111":

Barcode 1 (EAN13; 0001112223334) and Barcode 4 (Code39; 555222221111) match the criteria.

8) "Barcode Input" is "All", "Specific String" is "111", and "Specific Position" is "4":

Only Barcode 1 (EAN13; 0001112223334) matches the criteria.

9) "Barcode Input" is "All", "Specific String" is "111", and "Specific Position" is "1":

None of the barcodes fulfils the criteria.

ACTIONS

A rule contains multiple "Actions" which process the decoded barcode data conforms to the "criteria" and reformat the data to be transmitted.

CREATE A NEW ACTION

Please follow the steps to create a new action and define the reformatting instructions:

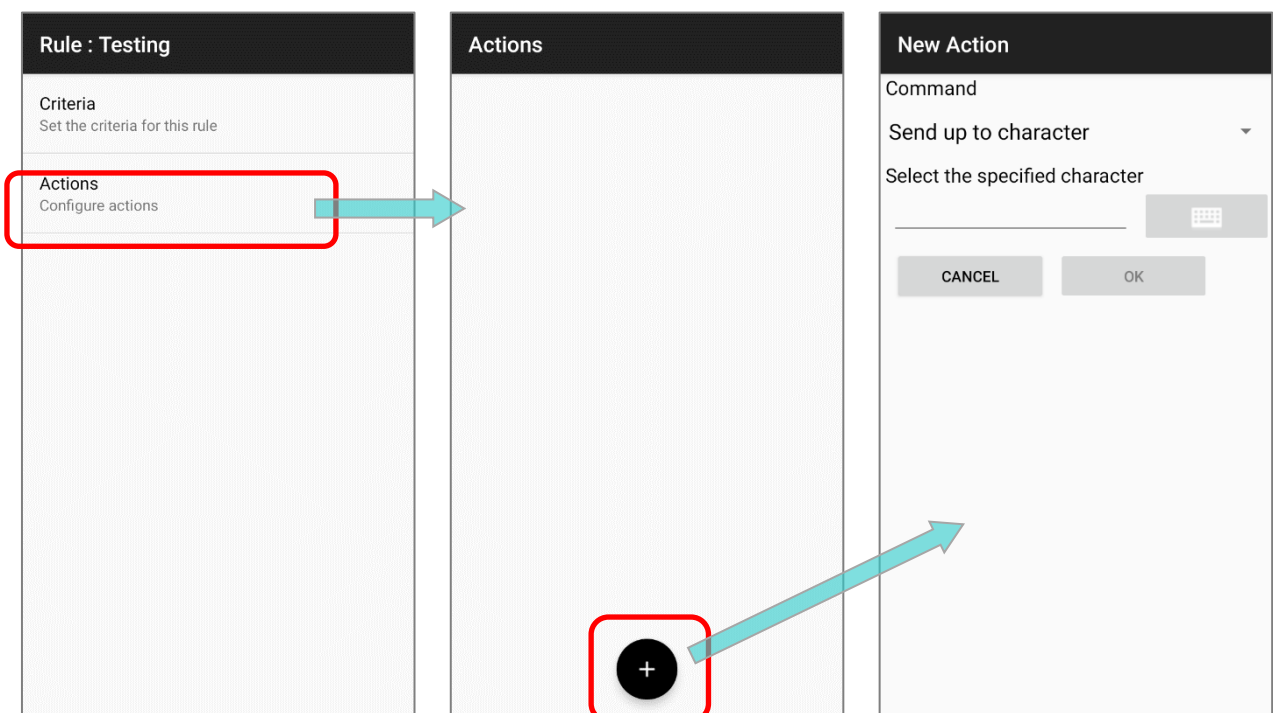
1) Tap on the "Add" button  and "New Action" page shows up:

- 2) Select the command from the drop-down menu, enter the necessary item(s) depending on the command you choose, and tap on "OK" to save the action.

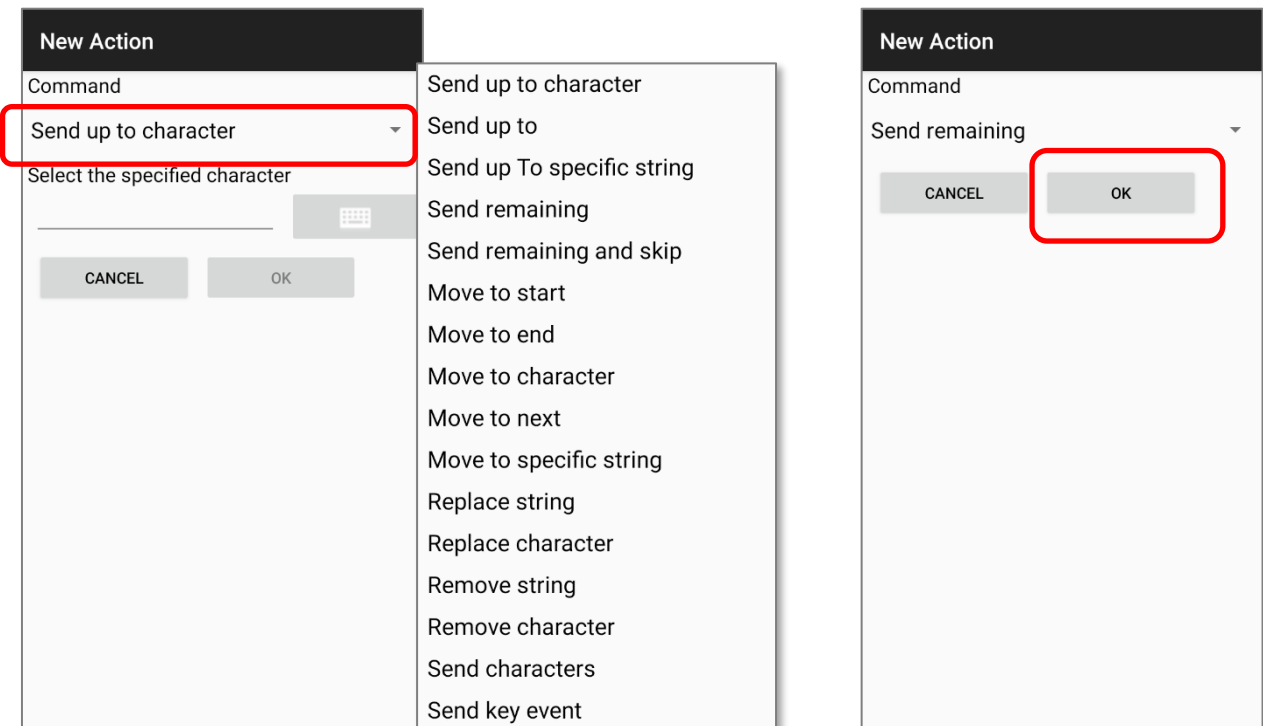

The available commands are divided into 6 groups:

SEND BARCODE DATA

"Send Barcode Data" actions affect the output character field and the output length (count of characters). All the other kinds of actions must collaborate with the "Send Barcode Data" actions to reformat the barcode data to be sent out.

Command	Description								
<p>Send up to character</p>	<p>To set a specific character as a period, and only the part anterior to this specific character will be output.</p> <table border="1" data-bbox="639 1682 1401 1928"> <thead> <tr> <th colspan="2">Example</th> </tr> </thead> <tbody> <tr> <td>The decoded data:</td> <td>0001112223334</td> </tr> <tr> <td>Actions:</td> <td>Send data up to "3".</td> </tr> <tr> <td>The output data:</td> <td>000111222</td> </tr> </tbody> </table>	Example		The decoded data:	0001112223334	Actions:	Send data up to "3".	The output data:	000111222
Example									
The decoded data:	0001112223334								
Actions:	Send data up to "3".								
The output data:	000111222								

Command	Description								
Send up to	<p>To set how many characters to be output.</p> <table border="1" data-bbox="639 416 1401 663"> <thead> <tr> <th colspan="2">Example</th> </tr> </thead> <tbody> <tr> <td>The decoded data:</td> <td>0001112223334</td> </tr> <tr> <td>Actions:</td> <td>Send up to "3" characters.</td> </tr> <tr> <td>The output data:</td> <td>000</td> </tr> </tbody> </table>	Example		The decoded data:	0001112223334	Actions:	Send up to "3" characters.	The output data:	000
Example									
The decoded data:	0001112223334								
Actions:	Send up to "3" characters.								
The output data:	000								
Send up To specific string	<p>To send the part up till the specific string (this specific string is excluded).</p> <table border="1" data-bbox="639 779 1401 1025"> <thead> <tr> <th colspan="2">Example</th> </tr> </thead> <tbody> <tr> <td>The decoded data:</td> <td>0001112223334</td> </tr> <tr> <td>Actions:</td> <td>Send up to the string "333".</td> </tr> <tr> <td>The output data:</td> <td>000111222</td> </tr> </tbody> </table>	Example		The decoded data:	0001112223334	Actions:	Send up to the string "333".	The output data:	000111222
Example									
The decoded data:	0001112223334								
Actions:	Send up to the string "333".								
The output data:	000111222								
Send remaining	<p>This command works with those commands of "Move Cursor" to send the data posterior to the cursor.</p> <table border="1" data-bbox="639 1182 1401 1469"> <thead> <tr> <th colspan="2">Example</th> </tr> </thead> <tbody> <tr> <td>The decoded data:</td> <td>0001112223334</td> </tr> <tr> <td>Actions:</td> <td>Move cursor to next 1. Send all the data that remains.</td> </tr> <tr> <td>The output data:</td> <td>001112223334</td> </tr> </tbody> </table>	Example		The decoded data:	0001112223334	Actions:	Move cursor to next 1. Send all the data that remains.	The output data:	001112223334
Example									
The decoded data:	0001112223334								
Actions:	Move cursor to next 1. Send all the data that remains.								
The output data:	001112223334								
Send remaining and skip	<p>To send all the data (posterior to the cursor) aside from the last character(s) you set.</p> <table border="1" data-bbox="639 1621 1401 1908"> <thead> <tr> <th colspan="2">Example</th> </tr> </thead> <tbody> <tr> <td>The decoded data:</td> <td>0001112223334</td> </tr> <tr> <td>Actions:</td> <td>Send all the data that remains and skip the last 1.</td> </tr> <tr> <td>The output data:</td> <td>000111222333</td> </tr> </tbody> </table>	Example		The decoded data:	0001112223334	Actions:	Send all the data that remains and skip the last 1.	The output data:	000111222333
Example									
The decoded data:	0001112223334								
Actions:	Send all the data that remains and skip the last 1.								
The output data:	000111222333								

MOVE CURSOR

The actions of “**Move Cursor**” must work with those “**Send Barcode Data**” actions to define the start position to output the decoded data.

Command	Description								
Move to start	<p>To move the cursor to the very beginning.</p> <table border="1" data-bbox="639 537 1401 815"> <thead> <tr> <th colspan="2" data-bbox="639 537 1401 593">Example</th> </tr> </thead> <tbody> <tr> <td data-bbox="639 593 887 651">The decoded data:</td> <td data-bbox="887 593 1401 651">000112223334</td> </tr> <tr> <td data-bbox="639 651 887 752">Actions:</td> <td data-bbox="887 651 1401 752">Move cursor to the start. Send all the data that remains.</td> </tr> <tr> <td data-bbox="639 752 887 815">The output data:</td> <td data-bbox="887 752 1401 815">000112223334</td> </tr> </tbody> </table>	Example		The decoded data:	000112223334	Actions:	Move cursor to the start. Send all the data that remains.	The output data:	000112223334
Example									
The decoded data:	000112223334								
Actions:	Move cursor to the start. Send all the data that remains.								
The output data:	000112223334								
Move to end	<p>To move the cursor to the end.</p> <table border="1" data-bbox="639 911 1401 1193"> <thead> <tr> <th colspan="2" data-bbox="639 911 1401 969">Example</th> </tr> </thead> <tbody> <tr> <td data-bbox="639 969 887 1030">The decoded data:</td> <td data-bbox="887 969 1401 1030">000112223334</td> </tr> <tr> <td data-bbox="639 1030 887 1133">Actions:</td> <td data-bbox="887 1030 1401 1133">Move cursor to the end. Send all the data that remains.</td> </tr> <tr> <td data-bbox="639 1133 887 1193">The output data:</td> <td data-bbox="887 1133 1401 1193">None.</td> </tr> </tbody> </table>	Example		The decoded data:	000112223334	Actions:	Move cursor to the end. Send all the data that remains.	The output data:	None.
Example									
The decoded data:	000112223334								
Actions:	Move cursor to the end. Send all the data that remains.								
The output data:	None.								
Move to character	<p>To move the cursor in front of the specific character you set.</p> <table border="1" data-bbox="639 1290 1401 1572"> <thead> <tr> <th colspan="2" data-bbox="639 1290 1401 1348">Example</th> </tr> </thead> <tbody> <tr> <td data-bbox="639 1348 887 1408">The decoded data:</td> <td data-bbox="887 1348 1401 1408">000112223334</td> </tr> <tr> <td data-bbox="639 1408 887 1512">Actions:</td> <td data-bbox="887 1408 1401 1512">Move cursor to the character “2”. Send all the data that remains.</td> </tr> <tr> <td data-bbox="639 1512 887 1572">The output data:</td> <td data-bbox="887 1512 1401 1572">2223334</td> </tr> </tbody> </table>	Example		The decoded data:	000112223334	Actions:	Move cursor to the character “ 2 ”. Send all the data that remains.	The output data:	2223334
Example									
The decoded data:	000112223334								
Actions:	Move cursor to the character “ 2 ”. Send all the data that remains.								
The output data:	2223334								
Move to next	<p>To move the cursor to the specific position from the beginning.</p> <table border="1" data-bbox="639 1668 1401 1951"> <thead> <tr> <th colspan="2" data-bbox="639 1668 1401 1727">Example</th> </tr> </thead> <tbody> <tr> <td data-bbox="639 1727 887 1787">The decoded data:</td> <td data-bbox="887 1727 1401 1787">000112223334</td> </tr> <tr> <td data-bbox="639 1787 887 1890">Actions:</td> <td data-bbox="887 1787 1401 1890">Move cursor to the next “5”. Send all the data that remains.</td> </tr> <tr> <td data-bbox="639 1890 887 1951">The output data:</td> <td data-bbox="887 1890 1401 1951">12223334</td> </tr> </tbody> </table>	Example		The decoded data:	000112223334	Actions:	Move cursor to the next “ 5 ”. Send all the data that remains.	The output data:	12223334
Example									
The decoded data:	000112223334								
Actions:	Move cursor to the next “ 5 ”. Send all the data that remains.								
The output data:	12223334								

Command	Description	
Move to specific string	To move the cursor in front of the specific string you set.	
	Example	
	The decoded data:	000112223334
	Actions:	Move cursor to the string “333” . Send all the data that remains.
	The output data:	3334

REPLACE DATA

Command	Description	
Replace String	To replace the specific string with the one you designate.	
	Example	
	The decoded data:	000112223334
	Actions:	Replace the string “333” with “CCC” . Send all the data that remains.
	The output data:	00011222CCC4
Replace character	To replace the specific character with the one you designate.	
	Example	
	The decoded data:	000112223334
	Actions:	Replace the character “0” with “C” . Send all the data that remains.
	The output data:	CCC112223334

REMOVE DATA

Command	Description								
<p style="text-align: center;">Remove string</p>	<p>To delete the specific string.</p> <table border="1" data-bbox="639 465 1401 748"> <thead> <tr> <th colspan="2" data-bbox="639 465 1401 528">Example</th> </tr> </thead> <tbody> <tr> <td data-bbox="639 528 887 591">The decoded data:</td> <td data-bbox="887 528 1401 591">000112223334</td> </tr> <tr> <td data-bbox="639 591 887 687">Actions:</td> <td data-bbox="887 591 1401 687">Remove the string "222". Send all the data that remains.</td> </tr> <tr> <td data-bbox="639 687 887 748">The output data:</td> <td data-bbox="887 687 1401 748">000113334</td> </tr> </tbody> </table>	Example		The decoded data:	000112223334	Actions:	Remove the string "222". Send all the data that remains.	The output data:	000113334
	Example								
	The decoded data:	000112223334							
	Actions:	Remove the string "222". Send all the data that remains.							
	The output data:	000113334							
<p style="text-align: center;">Remove character</p>	<p>To delete the specific character.</p> <table border="1" data-bbox="639 869 1401 1151"> <thead> <tr> <th colspan="2" data-bbox="639 869 1401 931">Example</th> </tr> </thead> <tbody> <tr> <td data-bbox="639 931 887 994">The decoded data:</td> <td data-bbox="887 931 1401 994">000112223334</td> </tr> <tr> <td data-bbox="639 994 887 1090">Actions:</td> <td data-bbox="887 994 1401 1090">Remove the character "3". Send all the data that remains.</td> </tr> <tr> <td data-bbox="639 1090 887 1151">The output data:</td> <td data-bbox="887 1090 1401 1151">000112224</td> </tr> </tbody> </table>	Example		The decoded data:	000112223334	Actions:	Remove the character "3". Send all the data that remains.	The output data:	000112224
	Example								
	The decoded data:	000112223334							
	Actions:	Remove the character "3". Send all the data that remains.							
	The output data:	000112224							

SEND CHARACTER

Command	Description								
<p style="text-align: center;">Send character</p>	<p>To add a specific character in front of the output data.</p> <table border="1" data-bbox="639 1585 1401 1868"> <thead> <tr> <th colspan="2" data-bbox="639 1585 1401 1648">Example</th> </tr> </thead> <tbody> <tr> <td data-bbox="639 1648 887 1711">The decoded data:</td> <td data-bbox="887 1648 1401 1711">000112223334</td> </tr> <tr> <td data-bbox="639 1711 887 1807">Actions:</td> <td data-bbox="887 1711 1401 1807">Send the character "C". Send up to "5" characters</td> </tr> <tr> <td data-bbox="639 1807 887 1868">The output data:</td> <td data-bbox="887 1807 1401 1868">C00011</td> </tr> </tbody> </table>	Example		The decoded data:	000112223334	Actions:	Send the character "C". Send up to "5" characters	The output data:	C00011
	Example								
	The decoded data:	000112223334							
	Actions:	Send the character "C". Send up to "5" characters							
	The output data:	C00011							

SEND KEYEVENT

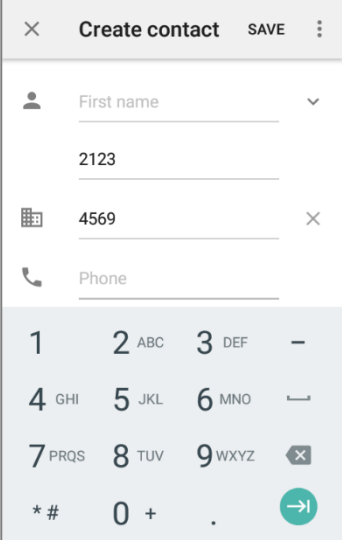
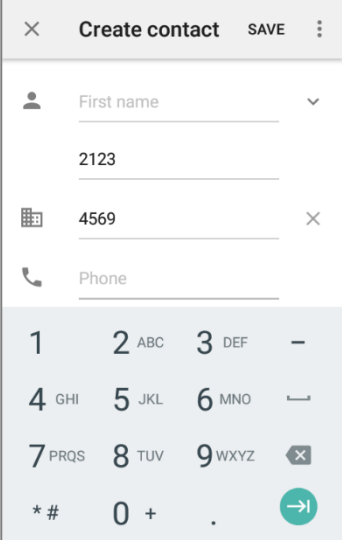
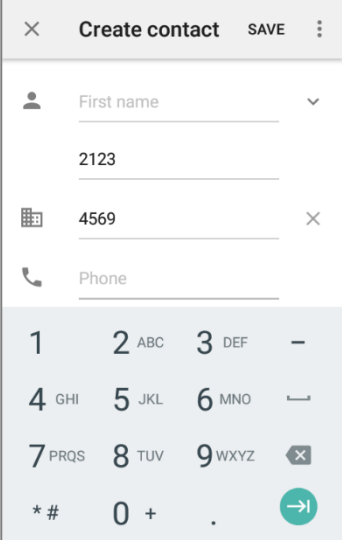
Command	Description								
Send key event	<p>To make a “Send key event” action to be effective, “Keyboard Emulation” should be set as “KeyEvent”.</p> <p>The following example is to output the data to two fields by “KeyEvent”:</p> <table border="1" data-bbox="639 611 1401 1469"> <thead> <tr> <th colspan="2" data-bbox="644 611 1396 674">Example</th> </tr> </thead> <tbody> <tr> <td data-bbox="644 674 890 734">The decoded data:</td> <td data-bbox="890 674 1396 734">21234569</td> </tr> <tr> <td data-bbox="644 734 890 891">Actions:</td> <td data-bbox="890 734 1396 891"> Send data Next 4 Send KeyEvent 0x1D Sebd Data Next 4 </td> </tr> <tr> <td data-bbox="644 891 890 1469">The output data:</td> <td data-bbox="890 891 1396 1469">  </td> </tr> </tbody> </table>	Example		The decoded data:	21234569	Actions:	Send data Next 4 Send KeyEvent 0x1D Sebd Data Next 4	The output data:	
Example									
The decoded data:	21234569								
Actions:	Send data Next 4 Send KeyEvent 0x1D Sebd Data Next 4								
The output data:									

Note:

The decoded data is processed by actions sequentially. The permutation of actions affects the output data, that is, different permutations of actions may result in different output data.

DELETE AN ACTION

- 1) Tap on more button  on the right of the action and select **"Delete"** from the menu.
- 2) Confirm that deleting this action by tapping on **"OK"**.

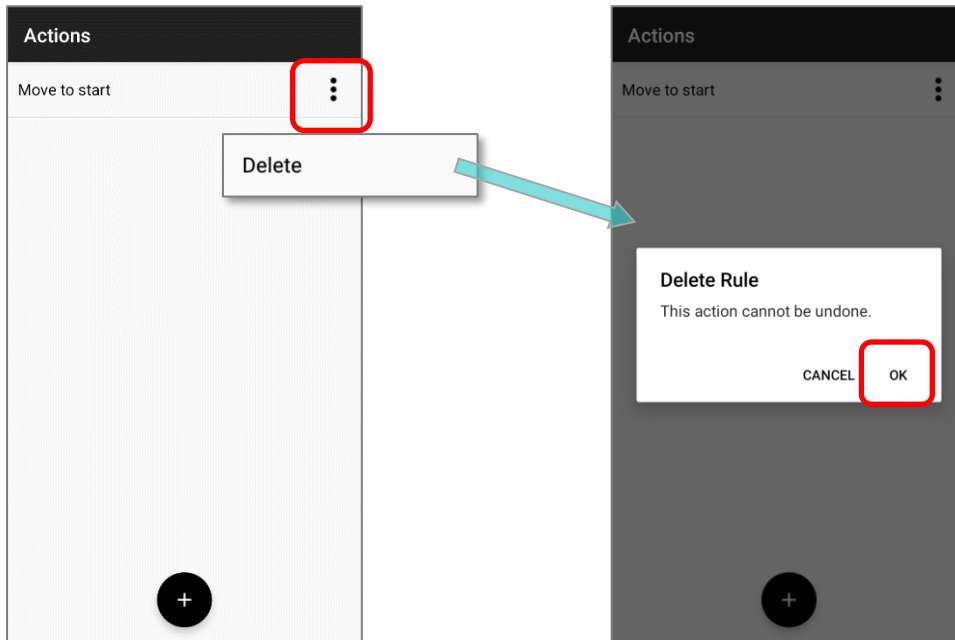

EDIT AN ACTION

To modify an existed action:

- 1) Tap on the action to be modified to enter **"Edit Action"** page.

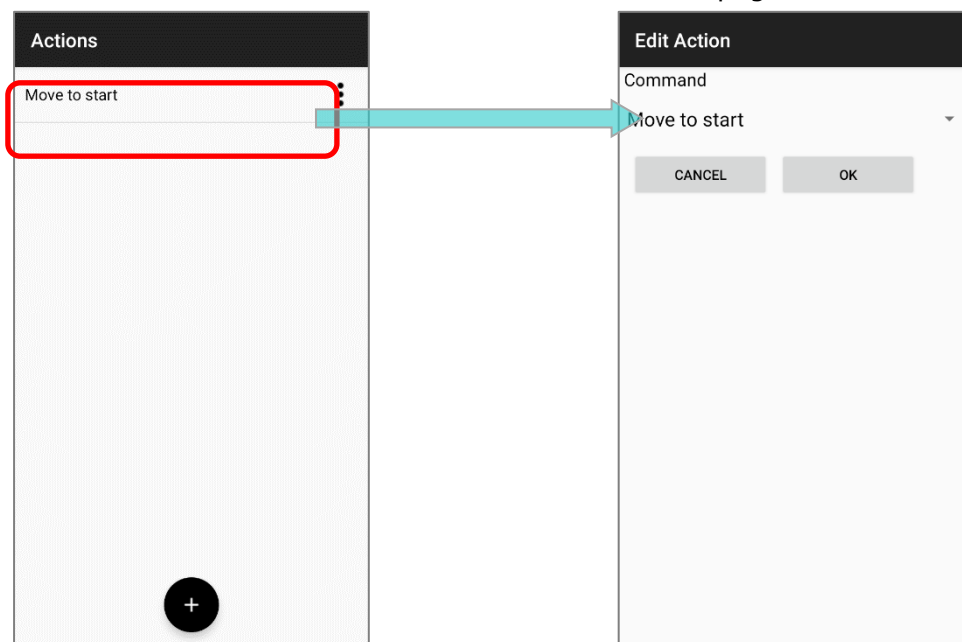

2) Select the command and tap on "OK" to complete editing action.

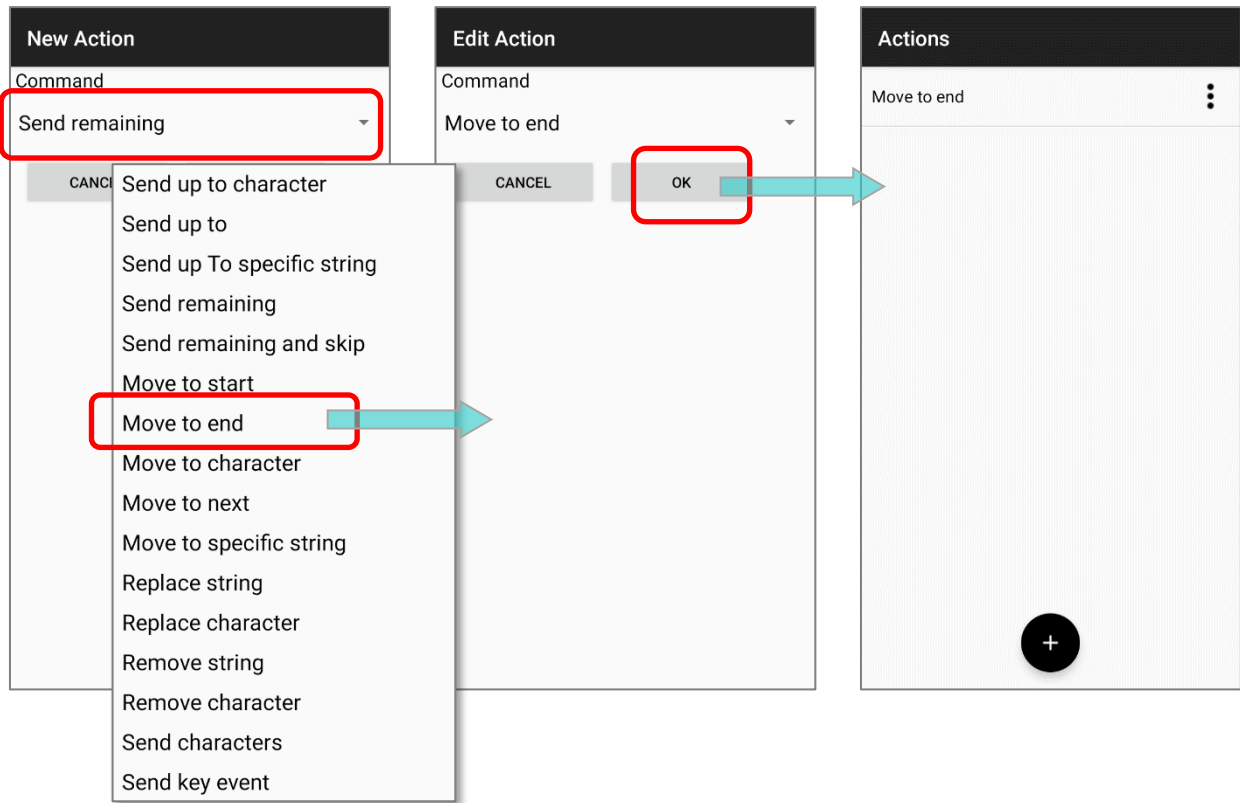

Note:

To make "Advanced Data Formatting" work, [the profile must be enabled](#).

EXAMPLES

The followings are some examples of **Advanced Data Formatting**:

EXAMPLE 1

Code Type	GS1-128	
Barcode	1193160905021011063294	
Criteria	Barcode Input = GS1-128 (EAN 128)	
Actions		
	Action	Process
	Move Cursor To Next 3	119 3 160905021011063294
	Send Data Next 5	119 31609 05021011063294
	Move Cursor To Next 7	119316090502101 1 063294
Send Data Next 7	119316090502101 1063294	
Result	316091063294	

EXAMPLE 2

Code Type	EAN8
Barcode	21234569 and 11234569
Criteria	Barcode Input = EAN8 Specific String = 2 String Position = 1
Actions	Send All Data That Remains Send Character 0 Send Character 0 Send Character 0 Send Character 0 Send Character 0
Result	2123456900000 But barcode is 11234569 without change.

6.2.3. SYMBOLOGY

The **Symbology** page sets the symbologies to read, and also enables/disables some feature(s) for a symbology to read, such as:

- ▶ Customize and transmit start/stop characters
- ▶ Verify/transmit check digits
- ▶ Enable/disable addon digits
- ▶ Convert to another symbology
- ▶ Transmit symbology ID

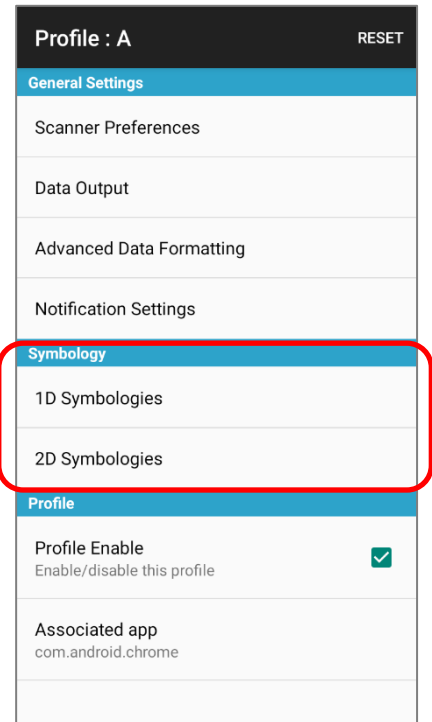

To open **Symbology** settings page, simply tap **1D Symbologies** or **2D Symbologies** (in case of a 2D imager) to list all symbologies which can be decoded.

1D Symbologies

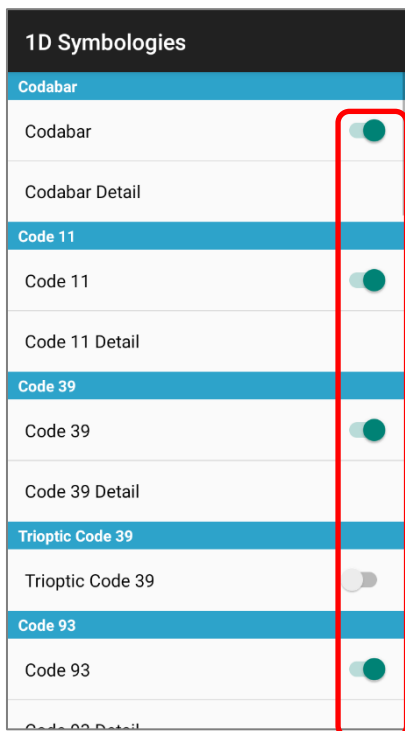

2D Symbologies

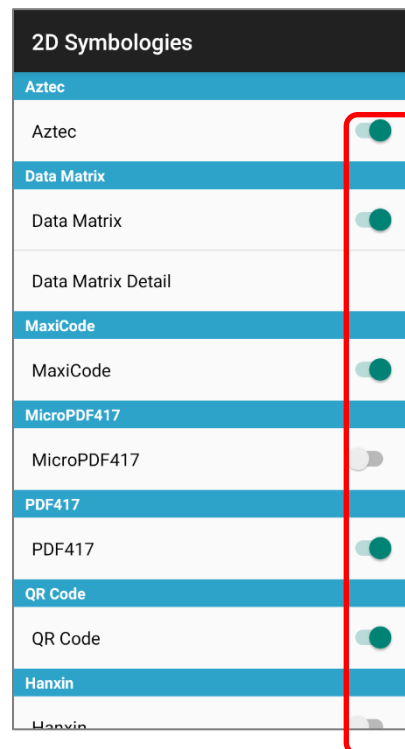

ENABLE/DISABLE SYMBOLOGY

Tap the label of each symbology to enable or disable it.

SYMBOLOGY SETTINGS

Tap the **Detail** label below each symbology to access detailed settings for the specific symbology.

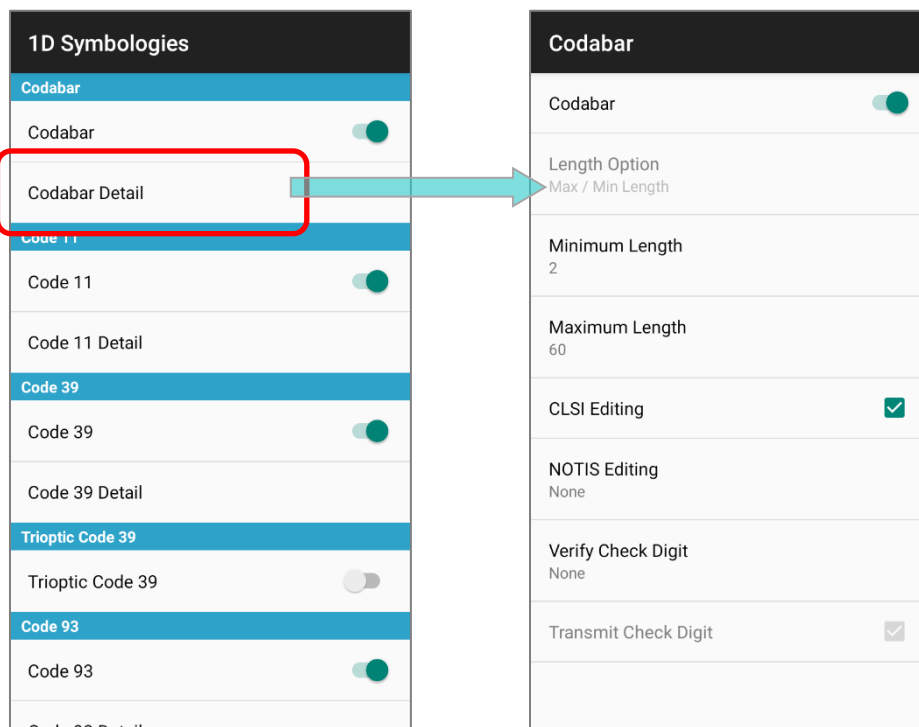

For details about the featured settings, please refer to [Symbology Settings](#).

6.2.4. PROFILE

With an **“Associated app”**, the profile can be enabled, and the **“Associated app”** will receive the decoded data output by **ReaderConfig** once the profile is enabled.

Note:

- (1) The **“Default”** profile doesn’t support **“Associated app”**, please assign **“Associated app”** to the profile(s) you create.
- (2) Multiple profiles can be enabled at the same time.

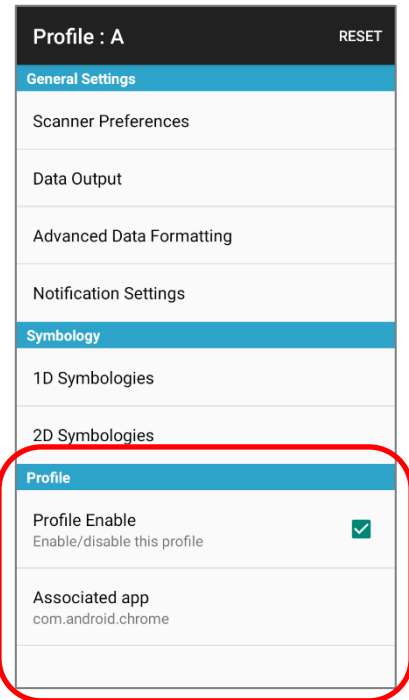

PROFILE ENABLE

To enable a profile:

- 1) Tap on the profile you’d like to enable to enter the profile main page.
- 2) Tap on **“Associated app”** under **“Profile”** to assign an app to be the **“Associated app”** to this profile.

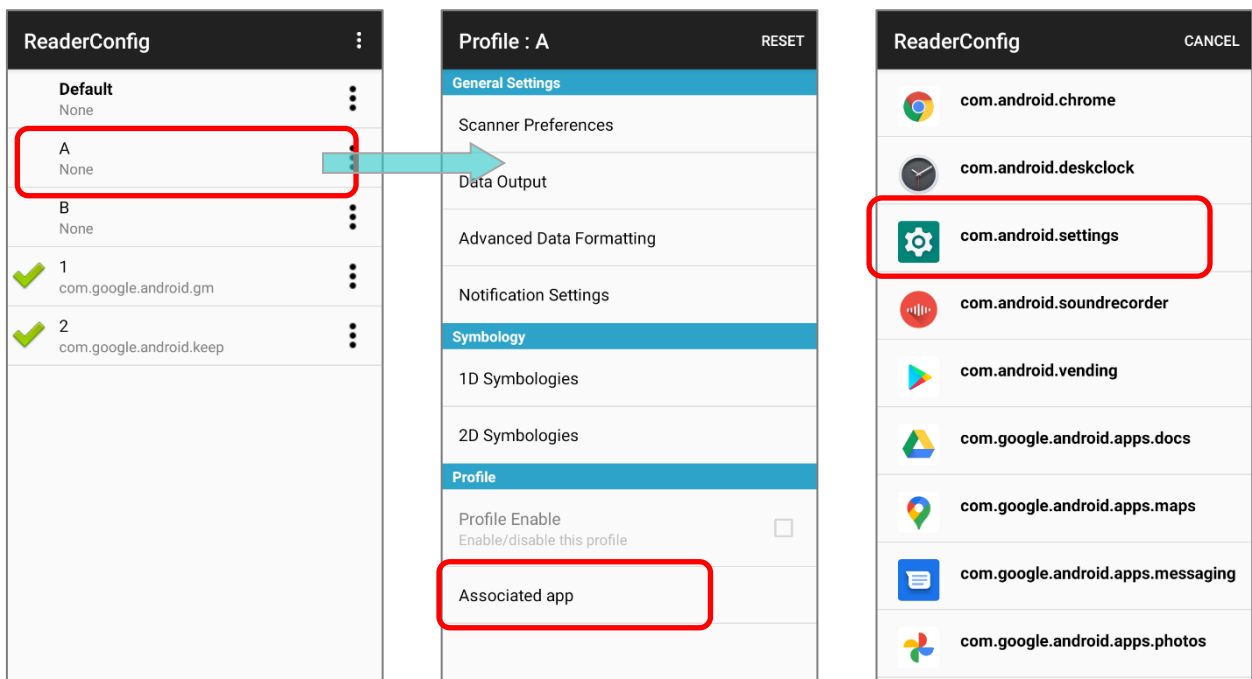

3) Now the function “**Profile Enable**” is available for user to tick the checkbox to enable this profile.

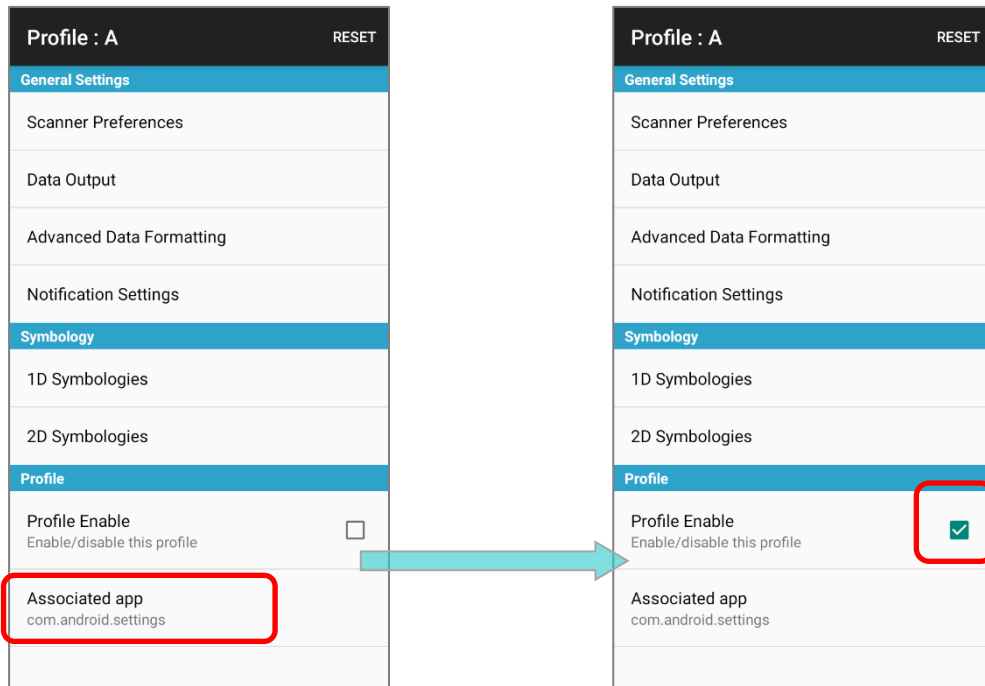

Return to **ReaderConfig** main screen, and you will find that the enabled profile(s) is with a check mark  next to it.

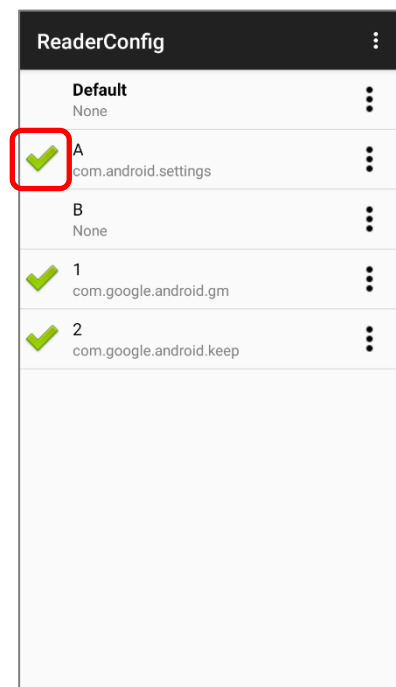

Note:

Multiple profiles can be enabled at the same time.

ASSOCIATED APP

To assign an app as the “**Associated app**” to a profile:

- 1) Enter the profile main page and tap on ap on “**Associated app**” under “**Profile**”.
- 2) Select the app to be the “**Associated app**” of this profile.

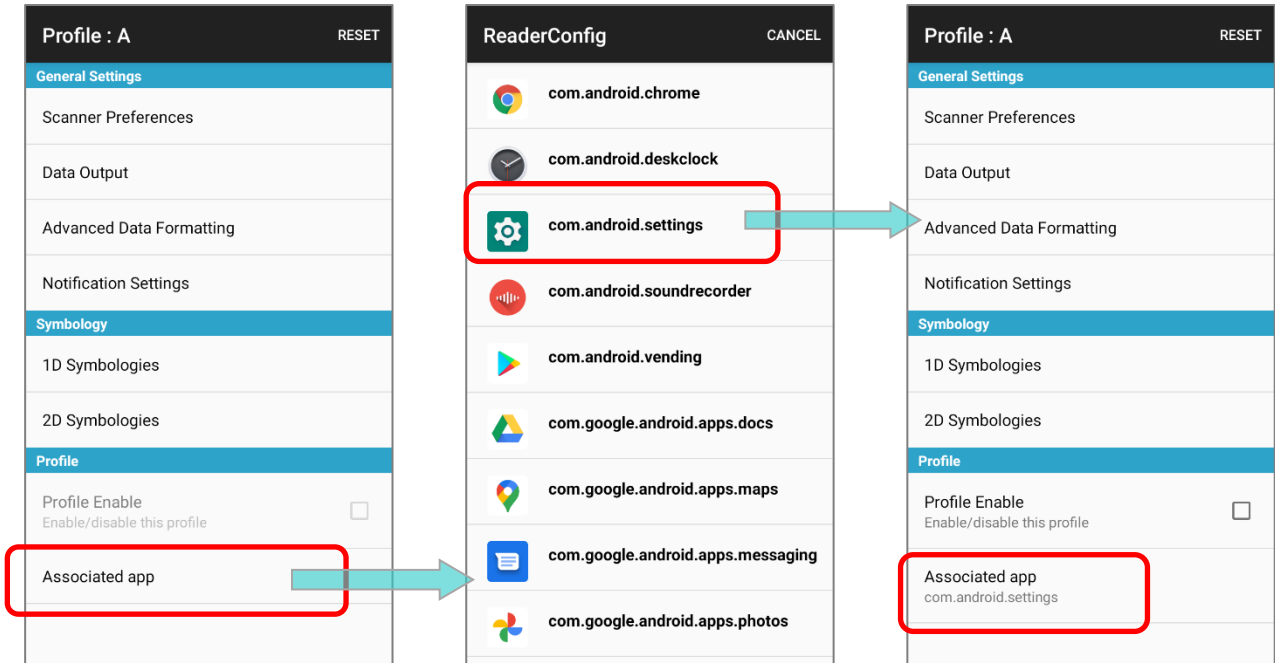

To clear the assigned “**Associated app**”, please tap on “**Associated app**” to enter the app list page, and tap on “**CANCEL**” on the action bar:

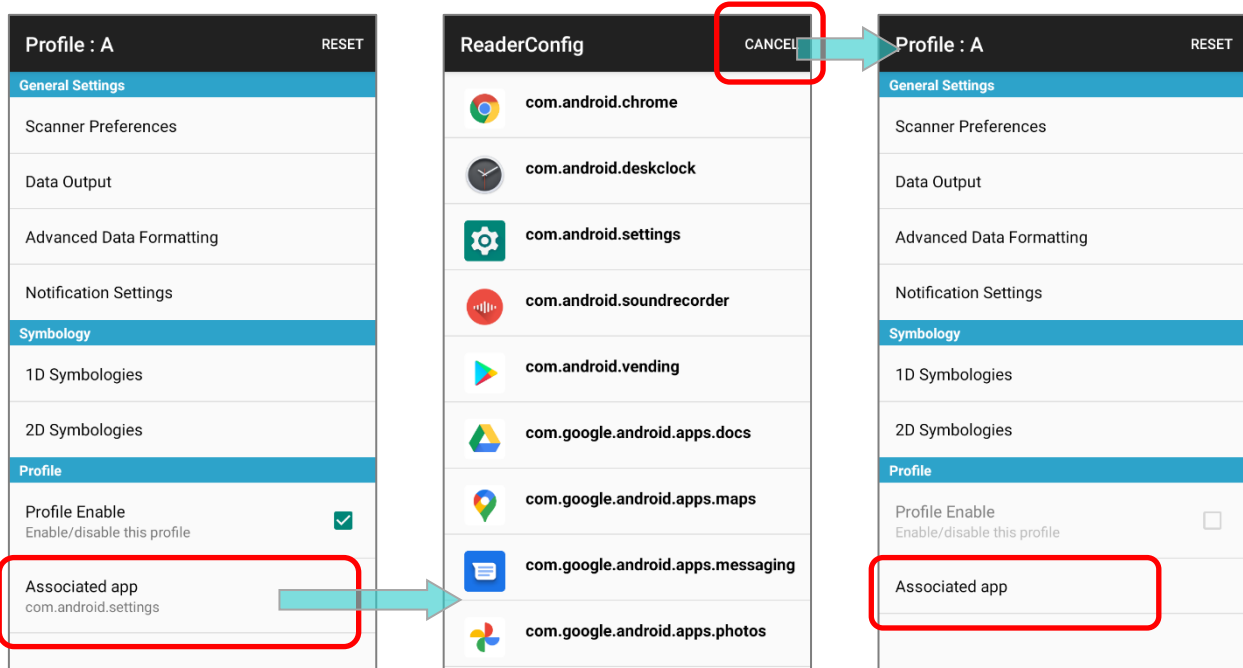

An app can be set as the associated app to only one profile. If the app you would like to select is already assigned to other profile, a prompt appears to remind you about this app is occupied by which profile.

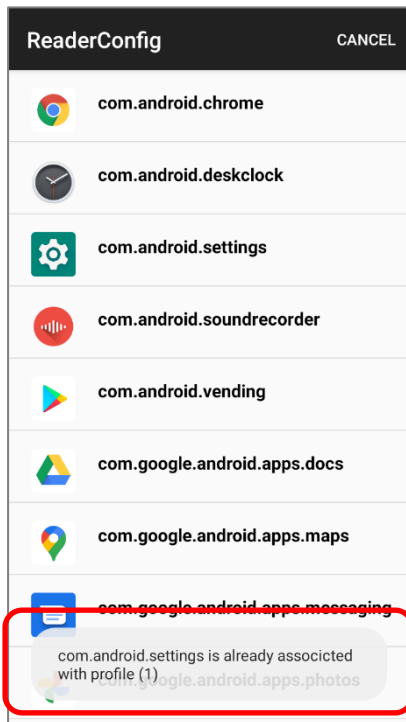

If a profile is enabled, its “**Associated app**” will receive the decoded data output by **ReaderConfig**.

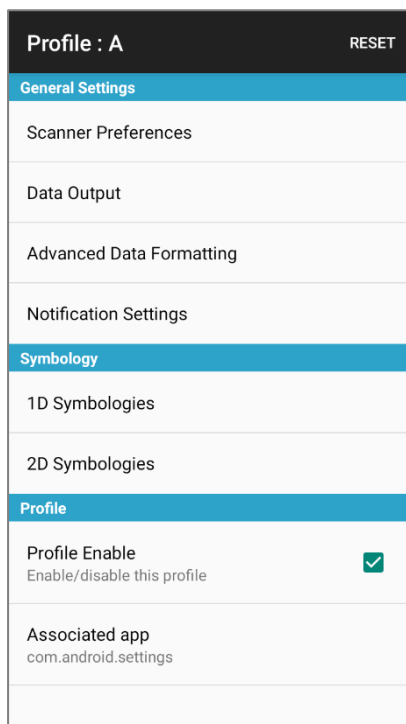

- 1) Launch the "**Associated app**" of the enabled profile.
- 2) Aim the scan window at the barcode and press the side trigger to read it.
- 3) The decoded data is sent to the "**Associated app**".

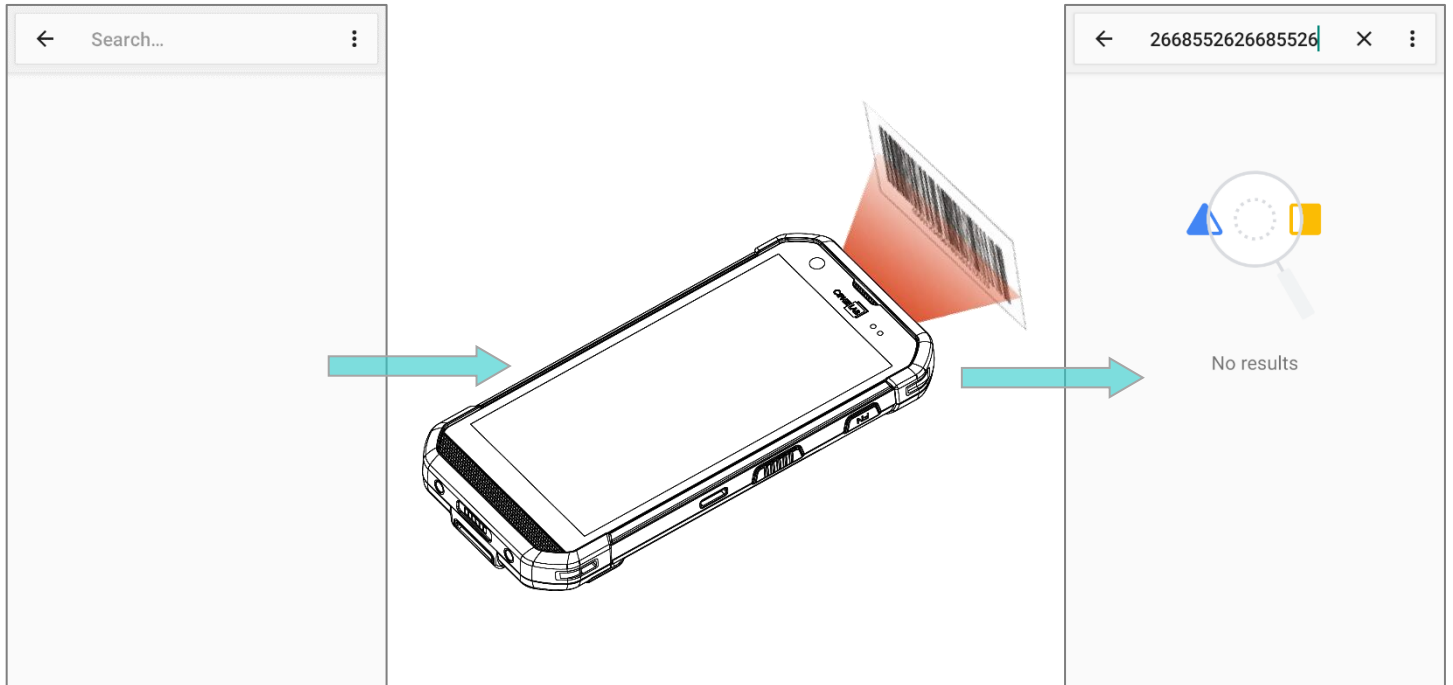

6.2.5. RESET

This function restores all settings in a profile to default.

To enable **Reset**:

- 1) Enter the profile main page of the profile you'd like to reset its settings.
- 2) Tap on "**RESET**" on the action bar.
- 3) Tap on "**OK**" on the confirmation dialog to reset or **Cancel** to close the dialog.

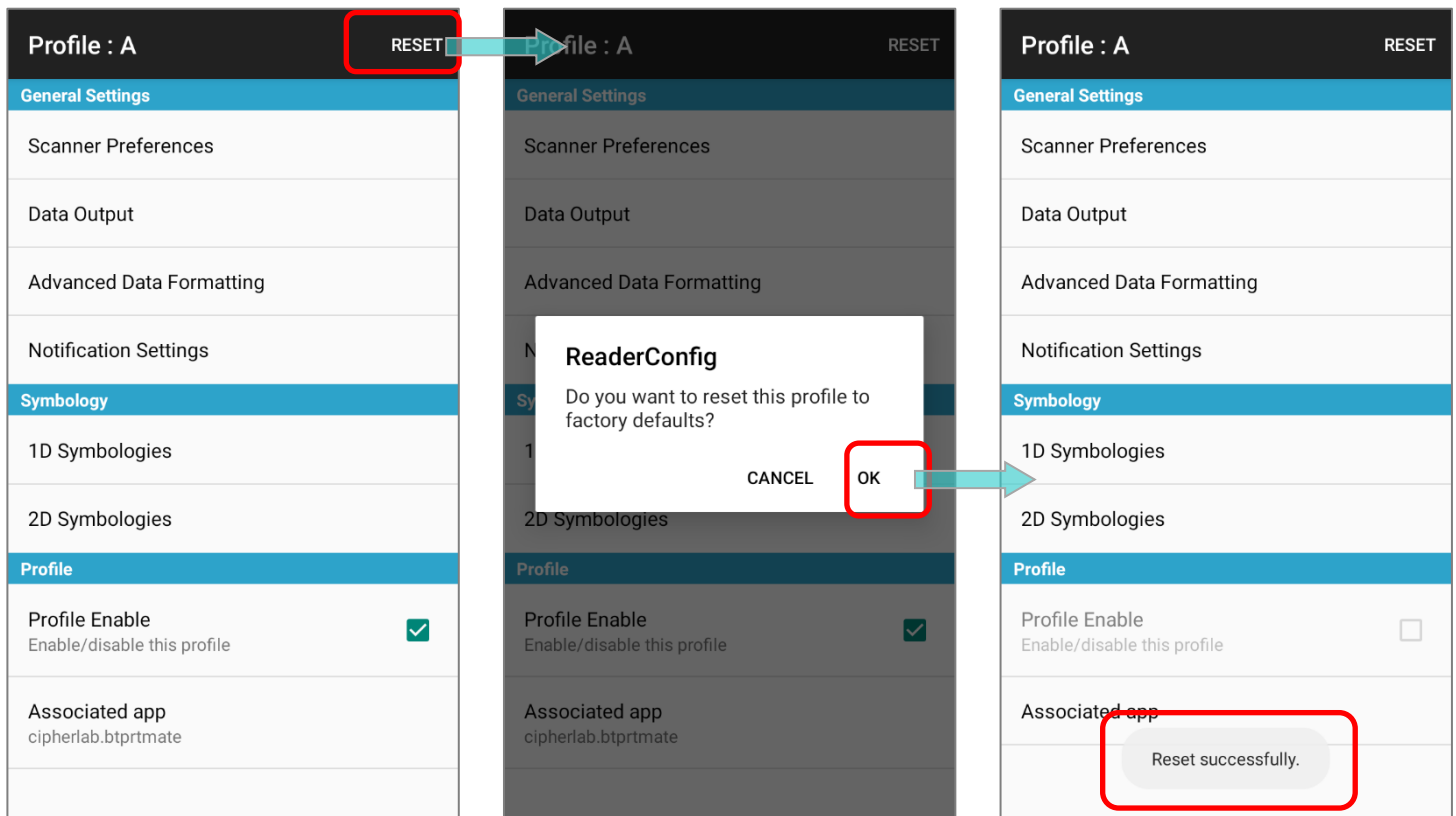

6.3. READ PRINTED BARCODES

Aside from output to destinations as per [Keyboard Emulation](#) settings, **ReaderConfig** provides a **Scan Test** feature for quick viewing of decoded data.

To perform test scanning of barcodes:

- 1) Open **ReaderConfig** as described in [Launch ReaderConfig](#).
- 2) On **ReaderConfig** main screen, tap the more button  on the action bar to open the main menu.
- 3) Tap on **Scan Test**. A Test Scan Form opens for displaying the scanned data.

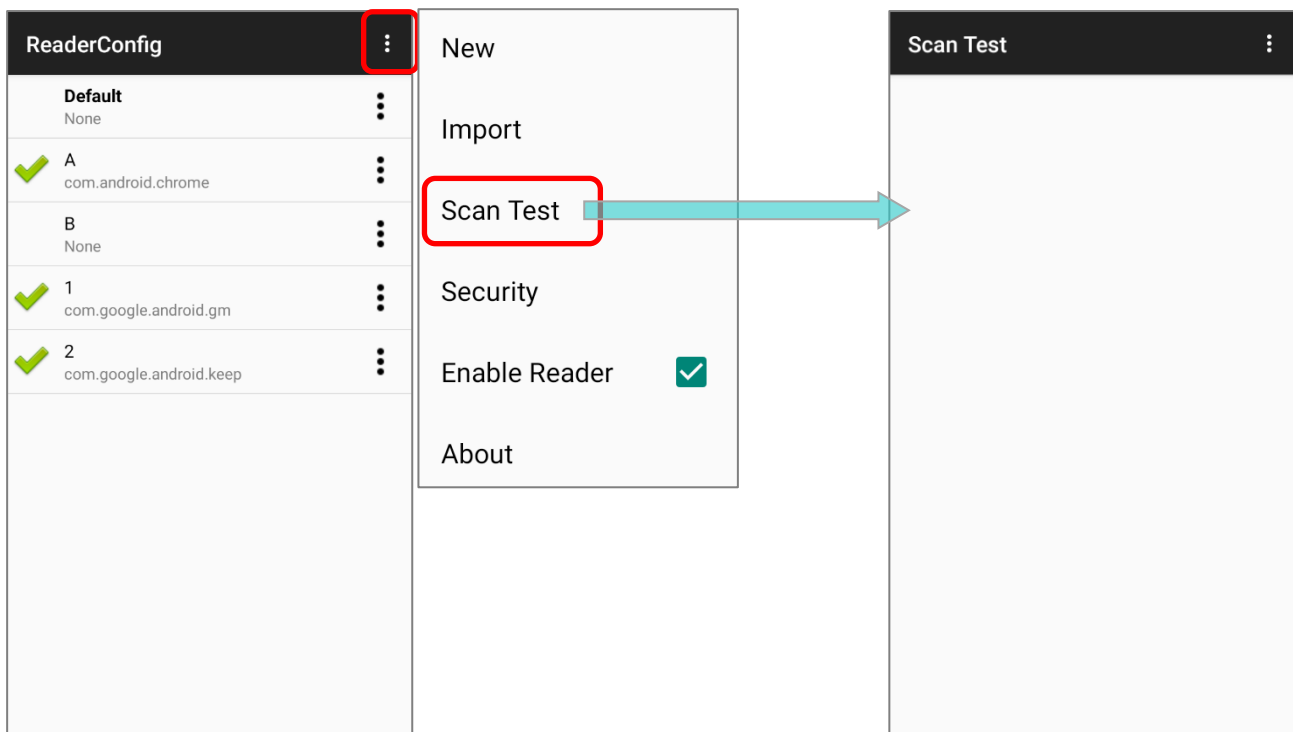

- 4) Aim the scanning window at the barcode to read and press any of the side trigger. The scanning light beams to read the printed barcodes. The scanning light goes off once the data is decoded, or when the decode timeout period has passed.

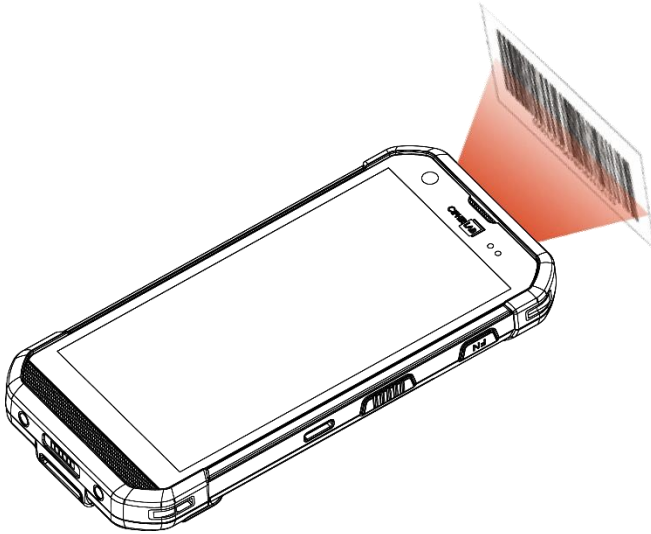

The decoded data will appear on the page. When finished viewing, tap back button to leave the test scan page; or tap the more button  and then "**Save**" to save the decoded data as a .txt file, or "**Clear All**" to clear all data on the screen.



SPECIFICATIONS

PLATFORM, PROCESSOR & MEMORY

Operating System & CPU

OS Version Android 10 with CTS and GMS Certified

CPU Qualcomm SDM450 Octa-core 1.8GHz

Memory

ROM 32GB eMMC (MLC)

RAM 3GB LPDDR3

Expansion Slot One Micro SDHC card slot (up to 32GB)
SDXC supported (up to 64GB-2TB)
Micro SIM socket x2 (optional), Micro SAM socket x1 (optional)

COMMUNICATION & DATA CAPTURE

Communication

USB Client	USB Type-C 2.0 OTG and charging contact
WPAN	Bluetooth® Class I, v4.0, v4.1, V4.2 V2.1+EDR (Enhanced Data Rate) (2402~2480 MHz: 7.16dBm)
WLAN	802.11 a/b/g/n/ac/d/h/I/r/k/v (2412~2472 MHz: 18.33dBm 5180~5240MHz: 19.46dBm, 5260~5320MHz: 20.35dBm, 5500~5700MHz: 20.92dBm, 5745~5825MHz: 20.06dBm)
WWAN	(2G) GSM: 850/900/1800/1900 (850/ 900: 33dBm; 1800 / 1900 : 30 dBm) (3G) UMTS/HSPA/HSPA+ (24dBm): B1(2100), B2(1900), B4(1700), B5(850), B6(850), B8(900) (4G) FDD LTE (23dBm): B1(2100), B2(1900), B3(1800), B4(1700), B5(850), B7(2600), B8(900), B12(700), B13(700), B17(700), B19(800), B20(800), B25(1900), B26(850), B28(700) (4G) TDD-LTE (23dBm): Band38, Band39, Band40, Band41(2545MHz~2655MHz)
GPS	Built-in GPS, GLONASS, BeiDou, AGPS, Galileo

Data & Image Capture

Digital Camera	Autofocus 13 megapixels with LED flash
Barcode Reader	2D imager
HF RFID Reader	Support Card emulation, Card reader, and P2P modes of operation; support ISO14443 Type A & B, ISO15693, and Felica NFC area should be located on the top-side (-19.83 dBuA/m at 10m)

ELECTRICAL CHARACTERISTICS

Battery

Main Battery Pack	<p>Rechargeable Li-polymer battery: 3.85V, 4000mAh</p> <p>Charging temperature: 0-40°C</p> <p>Minimum charging time: 4 hours @25°C</p> <p>For the first time charging the main battery, please charge it for at least 8 to 12 hours. The allowed battery charging ambient temperature is between 0°C to 40°C. It is recommended to charge the battery at room temperature (18°C to 25°C) for optimal performance.</p> <p>Please note that battery charging stops when ambient temperature drops below 0°C or exceeds 40°C.</p>
Backup Battery	<p>Rechargeable Li-Polymer battery: 3.7V, 90mAh</p> <p>Charging time: 4 hours (under the condition that it is always be charged except of power off)</p>
RTC Battery	<p>Rechargeable SMT type Li-battery: 3V, 1mAh</p> <p>Charging time: 12 hours (always be charged)</p> <p>RTC retention will be maintained for at least 72 hours when the main battery is removed.</p>

Power Adaptor

Power Supply Cord with Universal Power Adaptor	Input	AC 100~240 V, 50/60 Hz
	Output	DC 5V, 2A BSMI, CCC, FCC, CE, RCM, PSE, PSB, EAC, BIS

Working Time

Supports working time for up to 10 hours (2D imager) at 25 degrees

PHYSICAL CHARACTERISTICS

Color Touch Screen Display

Display	5.5 inch, Transmissive IPS LCD, sunlight visibility, Corning® Gorilla® Glass 3
Resolution	720 X 1440 Pixel

Notifications

Status LED	2 LEDs include one bi-color (green & red) LED for power indications, and one tri-color (blue, green, & red) LED for reader and system notification.
Audio	Speaker, dual array microphones with echo and noise cancellation Bluetooth headset support, Hands-Free Profile (HFP) 1.6 specification with Wideband speech. AMR-WB HD-voice support HAC support

Dimensions & Weight

Dimensions	165mm(L) x 76.8mm(W) x 17.9mm(T)
Weight	288g ±5g

ENVIRONMENTAL CHARACTERISTICS

Temperature

Operating	-20°C to 50°C
Storage	-30°C to 70°C
Charging	0°C to 40°C

Humidity

Operating	10% to 90% (non-condensing)
Storage	5% to 95% (non-condensing)

Resistance

Impact Resistance	1.5m(5ft.) multiple drops onto concrete, 6 faces drop 6 cycles; with protective boot: 1.8m (6ft.) multiple drops onto concrete, 6 drops on each side. 1.5 m without rubber boot, 1.8 m with rubber boot drop to concrete (3 units, 6-face drop 6 cycle) according to MIL-STD-810G at room temperature
Tumble Test	500 tumbles at 0.5 m per applicable IEC tumble specifications
Splash/Dust Resistance	IP65/IP67 under IEC standard 60529.
Electrostatic Discharge	±15 kV air discharge, ±8 kV contact discharge

PROGRAMMING SUPPORT

Development Environment & Tools

JAVA	Environment Android studio Software Development Kit: JAR
C#	Environment: Visual Studio Software Development Kit: DLL (Xamarin Library)

APPENDIX I

SCAN ENGINE SETTINGS

Reader Configuration sets the following reader types:

- ▶ 2D Imager

SYMBOLOGIES SUPPORTED

Depending on the scan engine integrated on the mobile computer, supported symbologies will differ as listed below. For details on configuring associated settings, refer to [Symbology Settings](#).

Codabar		✓
Code 11		✓
Code 39	Code 39	✓
	Trioptic Code 39	✓
	Italian Pharmacode (Code 32)	✓
Code 93		✓
Code 128	Code 128	✓
	GS1-128 (EAN-128)	✓
	ISBT 128	✓
Code 2 of 5	Chinese 25	✓
	Industrial 25 (Discrete 25)	✓
	Interleaved 25	✓
	Convert Interleaved 25 to EAN-13	✓
	Matrix 25	✓
Composite Code	Composite CC-A/B	✓
	Composite CC-C	✓
	Compostie TLC 39	✓

GS1 DataBar (RSS)	GS1 DataBar-14 (RSS-14)	✓
	GS1 DataBar Limited (RSS Limited)	✓
	GS1 DataBar Expanded (RSS Expanded)	✓
	Convert to UPC/EAN	✓
Korean 3 of 5		✓
MSI		✓
Postal Codes	Australian Postal	✓
	Japan Postal	✓
	Netherlands KIX Code	✓
	US Postnet	✓
	US Planet	✓
	USPS Postal	✓
	UPU FICS Postal	✓
	UK Postal	✓
EAN/UPC	EAN-8	✓
	EAN-8 Extend	✓
	EAN-13	✓
	Bookland EAN (ISBN)	✓
	ISSN EAN	✓
	UPC-A	✓
	UPC-E	✓
	Convert to UPC-A	✓
	UPC-E1	✓
	Convert to UPC-A	✓

Coupon Code		✓
2D Symbologies	Aztec	✓
	Data Matrix	✓
	Maxicode	✓
	MacroPDF	✓
	MicroPDF417	✓
	MicroQR	✓
	PDF417	✓
	QR Code	✓

SYMBOLGY SETTINGS

The tables below list the symbology settings for 2D imager.



N6703

1D SYMBOLOGIES

Symbology	Description	Default
CODABAR		
Codabar		Enable
Codabar	Switch to enable Codabar decoding.	Enable
Length Option	Set the length of the Codabar symbols to decode. <ul style="list-style-type: none"> ▶ Max / Min Length (range: 2-60; Length 1<Length 2) 	Max / Min Length (2-60)
CLSI Editing	When applied, the CLSI editing strips the start/stop characters and inserts a space after the first, fifth, and tenth characters of a 14-character Codabar barcode. <ul style="list-style-type: none"> ▶ The 14-character barcode length does not include start/stop characters. 	Disable
NOTIS Editing	Set whether to include start/stop characters in the transmitted data. <ul style="list-style-type: none"> ▶ NOTIS Editing is to strip the start/stop characters, i.e. to disable "Transmit Start/Stop Characters". 	Disable
NOTIS Editing Type	Options are None, ABCD/ABCD, abcd/abcd . "NOTIS Editing" must be enabled.	None
Verify Check Digit	Select whether to verify the Modulo 43 check digit. If the check digit is incorrect, the barcode will not be accepted.	None
Transmit Check Digit	Decide whether to include the check digit in the data to transmit. "Verify Check Digit" must be enabled.	Enable

Symbology	Description	Default
CODE 11		
Code 11		Enable
Code 11	Switch to enable Code 11 decoding.	Enable
Check Digit Option	Set whether to verify check digits according to the selected option. If the check digits are incorrect, the barcode will not be accepted. <ul style="list-style-type: none"> ▶ Disable ▶ One Check Digit ▶ Two Check Digit 	Disable
Transmit Check Digit	Selects whether to include check digits in the transmitted data. <ul style="list-style-type: none"> ▶ “Check Digit Option” must be enabled. 	Disable
Length option	Sets the length of the Code 11 symbols to decode. <ul style="list-style-type: none"> ▶ Max / Min Length (range: 4-80; Length 1<Length 2) 	Max / Min Length (4-80)
CODE 39		
Code 39		Enable
Code 39	Switch to enable Code 39 decoding.	Enable
Convert to Code 32	Selects whether to convert decoded data to Italian Pharmacode.	Disable
Verify Check Digit	Selects whether to verify the Modulo 43 check digit. If the check digit is incorrect, the barcode will not be accepted.	Disable
Transmit Check Digit	Decide whether to include the check digit in the data to transmit. <ul style="list-style-type: none"> ▶ “Verify Check Digit” must be enabled. 	Disable
Support Full ASCII	Selects whether to enable Code 39 Full ASCII decoding. Characters are paired to encode the full ASCII character set.	Disable
Length option	Sets the length of the Code 39 symbols to decode. <ul style="list-style-type: none"> ▶ Max / Min Length (range: 2-48; Length 1<Length 2) 	Max / Min Length (2-48)

Symbology	Description	Default
Trioptic Code 39		
Trioptic Code 39		Disable
Trioptic Code 39	Switch to enable Trioptic Code 39 decoding.	Disable
Code 93		
Code 93		Enable
Code 93	Switch to enable Code 93 decoding.	Enable
Length option	Sets the length of the Code 39 symbols to decode. ▶ Max / Min Length (range: 0-80; Length 1<Length 2)	Max / Min Length (0-80)
CODE 128		
Code 128		Enable
Code 128	Switch to enable Code 128 decoding.	Enable
Length option	Sets the length of the Code 128 symbols to decode. ▶ Max / Min Length (range: 0-80; Length 1<Length 2)	Max / Min Length (0-80)
GS1-128		Enable
GS1-128	Switch to enable GS1-128 decoding.	Enable
Separator Character	Enable the function code character separator, which is used to separate data fields of variable length and application identifiers of subsequent data fields in concatenated data strings. Tap on  to choose your input method between Keyboard input and Symbol table input to set a separator character to replace with.	None

Symbology	Description	Default
Enable App ID Separator	<p>Check to enable the separator configuration for Application Identifier.</p>  <p>The image shows a barcode with the number (00)123456789012345675 below it. Red brackets under the first two digits '00' are labeled 'Left Separator' and red brackets under the last two digits '75' are labeled 'Right Separator'.</p> <p>You can respectively set the Left Separator and Right Separator. Tap on  to choose your input method between Keyboard input and Symbol table input to set a separator character to replace with.</p>	Disable
ISBT 128		Enable
ISBT 128	Switch to enable ISBT 128 decoding.	Enable
CODE 2 OF 5		
Chinese 25		Enable
Chinese 25	Switch to enable Chinese 2 of 5 decoding.	Enable
Discrete 25		Enable
Discrete 25	Switch to enable Discrete 2 of 5 decoding.	Enable
Length option	<p>Sets the length of the Discrete 2 of 5 symbols to decode.</p> <ul style="list-style-type: none"> ▶ Max / Min Length (range: 4-48; Length 1<Length 2) 	Max / Min Length (4-48)
Interleaved 25		
Interleaved 25		Enable
Interleaved 25	Switch to enable Interleaved 2 of 5 decoding.	Enable
Length option	<p>Sets the length of Interleaved 2 of 5 symbols to decode.</p> <ul style="list-style-type: none"> ▶ Max / Min Length (range: 4-80; Length 1<Length 2) 	Max / Min Length (4-80)
Verify Check Digit	Decide whether to verify the check digit. If the check digit is incorrect, the barcode will not be accepted.	Disable
Transmit Check Digit	Decide whether to include the check digit in the data to transmit.	Disable



Symbology	Description	Default
Matrix 25		Enable
Matrix 25	Switch to enable Matrix 2 of 5 decoding.	Enable
Length option	Sets the length of the Matrix 2 of 5 symbols to decode. <ul style="list-style-type: none"> ▶ Max / Min Length (range: 4-80; Length 1 < Length 2) 	Max / Min Length (4-80)
Composite		
Composite CC-A/B		Disable
Composite CC-A/B	Switch to enable Composite CC-A/B decoding.	Disable
Composite CC-C		Disable
Composite CC-C	Switch to enable Composite CC-C decoding.	Disable
Composite TLC-39		Disable
Composite TLC-39	Switch to enable Composite TLC-39 decoding.	Disable
Composite General Preference		
UPC Composite Mode	UPC barcodes can be “linked” with a 2D barcode during transmission as if they were one barcode.	Disable
GS1 DataBar		
GS1 DataBar-14		Disable
GS1 DataBar-14	Switch to enable GS1 DataBar-14 decoding.	Disable
GS1 DataBar Limited		Enable
GS1 DataBar Limited	Switch to enable GS1 DataBar Limited decoding.	Enable
GS1 DataBar Expanded		Disable
GS1 DataBar Expanded	Switch to enable GS1 DataBar Expanded decoding.	Disable
Separator Character	Enable the function code character separator, which is used to separate data fields of variable length and application identifiers of subsequent data fields in concatenated data strings. <ul style="list-style-type: none"> ▶ “GS1 DataBar Expanded” must be enabled. 	None

Symbology	Description	Default
Korean 3 OF 5		
Korean 3 of 5		Disable
Korean 3 of 5	Switch to enable Korean 3 of 5 decoding.	Disable
MSI		
MSI		Enable
MSI	Switch to enable MSI decoding.	Enable
Length option	Sets the length of the MSI symbols to decode. ▶ Max / Min Length (range: 4-48; Length 1<Length 2)	Max / Min Length (4-48)
Transmit Check Digit	Decide whether to include the check digit in the data to transmit.	Disable
EAN		
EAN-8		Enable
EAN-8	Switch to enable EAN-8 decoding.	Enable
Addon 2	Decide whether to decode EAN-8 with addon 2. ▶ Ignore Addon ▶ Auto-discriminate	Ignore addon
Addon 5	Decide whether to decode EAN-8 with addon 5. ▶ Ignore Addon ▶ Auto-discriminate	Ignore addon
Transmit Check Digit	Decide whether to include the check digit in the data being transmitted.	Enable
EAN-13		Enable
EAN-13	Switch to enable EAN-13 decoding.	Enable
Addon 2	Decide whether to decode EAN-8 with addon 2. ▶ Ignore Addon ▶ Auto-discriminate	Ignore addon

Symbology	Description	Default
Addon 5	Decide whether to decode EAN-13 with addon 5. <ul style="list-style-type: none"> ▶ Ignore Addon ▶ Auto-discriminate 	Ignore addon
Transmit Check Digit	Decide whether to include the EAN-13 check digit (the last character in the barcode) in the data being transmitted.	Enable
UPC		
UPC-A		Enable
UPC-A	Switch to enable UPC-A decoding.	Enable
Addon 2	Decide whether to decode UPC-A with addon 2. <ul style="list-style-type: none"> ▶ Ignore Addon ▶ Auto-discriminate 	Ignore addon
Addon 5	Decide whether to decode UPC-A with addon 5. <ul style="list-style-type: none"> ▶ Ignore Addon ▶ Auto-discriminate 	Ignore addon
Preamble	Decide whether to include the UPC-A preamble System Character (and Country Code) in the data being transmitted. <ul style="list-style-type: none"> ▶ No transmit: transmits none of the above ▶ Transmit System Character: transmits system number only 	Transmit System Character
Transmit Check Digit	Decide whether to include the UPC-A check digit (the last character in the barcode) in the data being transmitted.	Enable
Convert to EAN-13	Checkbox to enable converting EAN-8 to EAN-13 format.	Disable
UPC-E		Enable
UPC-E	Switch to enable UPC-E decoding.	Enable
Addon 2	Decide whether to decode UPC-E with addon 2. <ul style="list-style-type: none"> ▶ Ignore Addon ▶ Auto-discriminate 	Ignore addon

Symbology	Description	Default
Addon 5	Decide whether to decode UPC-E with addon 5. <ul style="list-style-type: none"> ▶ Ignore Addon ▶ Auto-discriminate 	Ignore addon
Preamble	Decide whether to include the UPC-E preamble System Character (and Country Code) in the data being transmitted. <ul style="list-style-type: none"> ▶ No transmit: transmits none of the above ▶ Transmit System Character: transmits system number only 	Transmit System Character
Convert to UPC-A	The UPC-E barcode will be expanded into UPC-A format, and the next process will follow the settings configured for UPC-A.	Disable
Transmit Check Digit	Decide whether to include the UPC-E1 check digit (the last character in the barcode) in the data being transmitted.	Enable
UPC-E1		Disable
UPC-E1	Switch to enable UPC-E1 decoding.	Disable
Telepen		
Telepen		Disable
Length option	Sets the length of the MSI symbols to decode. <ul style="list-style-type: none"> ▶ Max / Min Length (range: 1-60; Length 1<Length 2) 	Max / Min Length (1-60)
Coupon Code		
Goupon Code		Disable
Coupon Code	Switch to enable Coupon Code decoding.	Disable

2D SYMBOLOGIES

Symbology	Description	Default
Aztec		
Aztec		Enable
Aztec	Switch to enable Aztec decoding.	Enable
Data Matrix		
Data Matrix		Enable
Data Matrix	Switch to enable Data Matrix decoding.	Enable
Separator Character	Enable the function code character separator, which is used to separate data fields of variable length and application identifiers of subsequent data fields in concatenated data strings.	None
Enable App ID Separator	<p>Check to enable the separator configuration for Application Identifier.</p>  <p>You can respectively set the Left Separator and Right Separator. Tap on  to choose your input method between Keyboard input and Symbol table input to set a separator character to replace with.</p>	Disable
MaxiCode		
MaxiCode		Enable
MaxiCode	Switch to enable MaxiCode decoding.	Enable
MicroPDF417		
MicroPDF417		Disable
MicroPDF417	Switch to enable MicroPDF417 decoding.	Disable

Symbology	Description	Default
PDF417		
PDF417		Enable
PDF417	Switch to enable PDF417 decoding.	Enable
QR Code		
QR Code		Enable
QR Code	Switch to enable QR Code decoding.	Enable
Hanxin		
Hanxin		Disable
Hanxin	Switch to enable Hanxin decoding.	Disable



SE4770

1D SYMBOLOGIES

Symbology	Description	Default
CODABAR		
Codabar		Enable
Codabar	Switch to enable Codabar decoding.	Enable
Length Option	<p>Set the length of the Codabar symbols to decode.</p> <ul style="list-style-type: none"> ▶ One Fixed length (Length 1) ▶ Two Fixed lengths (Length 1>Length 2) ▶ Max / Min Length (range: 0-55; Length 1<Length 2) ▶ Any Length 	Max / Min Length (4-55)
CLSI Editing	<p>When applied, the CLSI editing strips the start/stop characters and inserts a space after the first, fifth, and tenth characters of a 14-character Codabar barcode.</p> <ul style="list-style-type: none"> ▶ The 14-character barcode length does not include start/stop characters. 	Disable
NOTIS Editing	<p>Set whether to include start/stop characters in the transmitted data.</p> <ul style="list-style-type: none"> ▶ NOTIS Editing is to strip the start/stop characters, i.e. to disable "Transmit Start/Stop Characters". 	Disable
NOTIS Editing Type	<p>Options are None, ABCD/ABCD, abcd/abcd.</p> <p>"NOTIS Editing" must be enabled.</p>	None
Verify Check Digit	Select whether to verify the Modulo 43 check digit. If the check digit is incorrect, the barcode will not be accepted.	None
Transmit Check Digit	<p>Decide whether to include the check digit in the data to transmit.</p> <p>"Verify Check Digit" must be enabled.</p>	Enable

Symbology	Description	Default
CODE 11		
Code 11		Disable
Code 11	Switch to enable Code 11 decoding.	Disable
Check Digit Option	Set whether to verify check digits according to the selected option. If the check digits are incorrect, the barcode will not be accepted. <ul style="list-style-type: none"> ▶ Disable ▶ One Check Digit ▶ Two Check Digit 	Disable
Transmit Check Digit	Selects whether to include check digits in the transmitted data. <ul style="list-style-type: none"> ▶ Check Digit Option” must be enabled. 	Disable
Length option	Sets the length of the Code 11 symbols to decode. <ul style="list-style-type: none"> ▶ One Fixed length (Length 1) ▶ Two Fixed lengths (Length 1>Length 2) ▶ Max / Min Length (range: 0-55; Length 1<Length 2) ▶ Any Length 	Max / Min Length (4-55)
CODE 39		
Code 39		Enable
Code 39	Switch to enable Code 39 decoding.	Enable
Convert to Code 32	Selects whether to convert decoded data to Italian Pharmacode.	Disable
Transmit Check Digit (Code 32)	Decide whether to include the check digit in the data to transmit. <ul style="list-style-type: none"> ▶ “Convert to Code 32” must be enabled. 	Disable
Code 32 Prefix	Prefix character “A” to Code 32 barcodes. <ul style="list-style-type: none"> ▶ “Convert to Code 32” must be enabled for this to function properly. 	Disable
Verify Check Digit	Selects whether to verify the Modulo 43 check digit. If the check digit is incorrect, the barcode will not be accepted.	Disable

Symbology	Description	Default
Transmit Check Digit	Decide whether to include the check digit in the data to transmit. <ul style="list-style-type: none"> ▶ “Verify Check Digit” must be enabled. 	Disable
Support Full ASCII	Selects whether to enable Code 39 Full ASCII decoding. Characters are paired to encode the full ASCII character set.	Disable
Length option	Sets the length of the Code 39 symbols to decode. <ul style="list-style-type: none"> ▶ One Fixed length (Length 1) ▶ Two Fixed lengths (Length 1>Length 2) ▶ Max / Min Length (range: 0-55; Length 1<Length 2) ▶ Any Length 	Max / Min Length (4-55)
Security Level	Select the security level from Level 0 to Level 3	Level 0
TRIOPTIC CODE 39		
Trioptic Code 39		Disable
Trioptic Code 39	Switch to enable Trioptic Code 39 decoding.	Disable
CODE 93		
Code 93		Enable
Code 93	Switch to enable Code 93 decoding.	Enable
Length option	Sets the length of the Code 93 symbols to decode. <ul style="list-style-type: none"> ▶ One Fixed length (Length 1) ▶ Two Fixed lengths (Length 1>Length 2) ▶ Max / Min Length (range: 0-55; Length 1<Length 2) ▶ Any Length 	Max / Min Length (4-55)
CODE 128		
Code 128		Enable
Code 128	Switch to enable Code 128 decoding.	Enable

Symbology	Description	Default
Length option	<p>Sets the length of the Code 128 symbols to decode.</p> <ul style="list-style-type: none"> ▶ One Fixed length (Length 1) ▶ Two Fixed lengths (Length 1>Length 2) ▶ Max / Min Length (range: 0-55; Length 1<Length 2) ▶ Any Length 	Max / Min Length (0-55)
Security Level	Select the security level from Level 0 to Level 3	Level 1
GS1-128		Enable
GS1-128	Switch to enable GS1-128 decoding.	Enable
Separator Character	<p>Enable the function code character separator, which is used to separate data fields of variable length and application identifiers of subsequent data fields in concatenated data strings.</p> <p>Tap on  to choose your input method between Keyboard input and Symbol table input to set a separator character to replace with.</p>	None
Enable App ID Separator	<p>Check to enable the separator configuration for Application Identifier.</p>  <p>The image shows a barcode with the application identifier '(00)' and a series of numbers '123456789012345675'. Below the numbers, there are two red arrows pointing to the left and right separators, labeled 'Left Separator' and 'Right Separator' respectively.</p> <p>You can respectively set the Left Separator and Right Separator. Tap on  to choose your input method between Keyboard input and Symbol table input to set a separator character to replace with.</p>	Disable
ISBT 128		Enable
ISBT 128	Switch to enable ISBT 128 decoding.	Enable

Symbology	Description	Default
Concatenation	<p>Sets whether to enable decoding ISBT 128 by performing concatenation of ISBT data.</p> <ul style="list-style-type: none"> ▶ Disable: Does not perform concatenation ▶ Enable: Performs concatenation on all ISBT-128 barcodes. ▶ Auto-discriminate: Auto-discriminates between the ISBT 128 barcodes which require concatenation and those which do not need concatenation. 	Disable
Redundancy	When “Auto-discriminate” is applied, decide the number of times of supplementary decoding the same barcode to count as a valid read. Configurable between 2 and 20.	10
Chinese 25		
Chinese 25		Enable
Chinese 25	Switch to enable Chinese 2 of 5 decoding.	Enable
Discrete 25		
Discrete 25		Enable
Discrete 25	Switch to enable Discrete 2 of 5 decoding.	Enable
Length option	<p>Sets the length of the Discrete 2 of 5 symbols to decode.</p> <ul style="list-style-type: none"> ▶ One Fixed length (Length 1) ▶ Two Fixed lengths (Length 1>Length 2) ▶ Max / Min Length (range: 0-55; Length 1<Length 2) ▶ Any Length 	Max / Min Length (4-55)
Interleaved 25		
Interleaved 25		Enable
Interleaved 25	Switch to enable Interleaved 2 of 5 decoding.	Enable

Symbology	Description	Default
Length option	Sets the length of Interleaved 2 of 5 symbols to decode. <ul style="list-style-type: none"> ▶ One Fixed length (Length 1) ▶ Two Fixed lengths (Length 1>Length 2) ▶ Max / Min Length (range: 0-55; Length 1<Length 2) ▶ Any Length 	Max / Min Length (4-55)
Verify Check Digit	Decide whether to verify the check digit. If the check digit is incorrect, the barcode will not be accepted.	Disable
Transmit Check Digit	Decide whether to include the check digit in the data to transmit.	Disable
Convert to EAN-13	Convert a 14-character Interleaved 25 barcode into EAN-13 if the following requirements are met: The barcode must have a leading 0 and a valid EAN-13 check digit.	Disable
Security Level	Select the security level from Level 0 to Level 3	Level 1
Matrix 25		
Matrix 25		Enable
Matrix 25	Switch to enable Matrix 2 of 5 decoding.	Enable
Length option	Sets the length of the Matrix 2 of 5 symbols to decode. <ul style="list-style-type: none"> ▶ One Fixed length (Length 1) ▶ Two Fixed lengths (Length 1>Length 2) ▶ Max / Min Length (range: 0-55; Length 1<Length 2) ▶ Any Length 	Max / Min Length (4-55)
Redundancy	Enables or disable read redundancy for Matrix 2 of 5.	Disable
Verify Check Digit	Decide whether to verify the check digit. If the check digit is incorrect, the barcode will not be accepted.	Disable
Transmit Check Digit	Decide whether to include the check digit in the data to transmit.	Disable

Symbology	Description	Default
Composite		
Composite CC-A/B		Disable
Composite CC-A/B	Switch to enable Composite CC-A/B decoding.	Disable
Composite CC-C		Enable
Composite CC-C	Switch to enable Composite CC-C decoding.	Enable
Composite TLC-39		Disable
Composite TLC-39	Switch to enable Composite TLC-39 decoding.	Disable
UPC Composite Mode	<p>UPC barcodes can be "linked" with a 2D barcode during transmission as if they were one barcode.</p> <ul style="list-style-type: none"> ▶ UPC Never Linked: Transmit UPC barcodes regardless of whether a 2D barcode is detected. ▶ UPC Always Linked: Transmit UPC barcodes and the 2D portion. If the 2D portion is not detected, the UPC barcode will not be transmitted. <p>Note: CC-A/B or CC-C must be enabled.</p> <ul style="list-style-type: none"> ▶ Auto-discriminate: Transmit UPC barcodes as well as the 2D portion if present. 	UPC always Linked
GS1-128 Emulation Mode	Sets GS1-128 emulation mode for UCC/EAN Composite Codes.	Disable
GS1 DataBar		
GS1 DataBar-14		Enable
GS1 DataBar-14	Switch to enable GS1 DataBar-14 decoding.	Enable
Convert to UPC/EAN	Strips the leading '010' of GS1 DataBar and converts the barcode to EAN-13.	Disable
Security Level	Select the security level from Level 0 to Level 3	Level 1

Symbology	Description	Default
GS1 DataBar Limited		Enable
GS1 DataBar Limited	Switch to enable GS1 DataBar Limited decoding.	Enable
Convert to UPC/EAN	Strips the leading '010' of GS1 DataBar and converts the barcode to EAN-13.	Disable
Security Level	Select the security level from Level 0 to Level 3	Level 3
GS1 DataBar Expanded		Enable
GS1 DataBar Expanded	Switch to enable GS1 DataBar Expanded decoding.	Enable
Separator Character	Separator Character Enable the function code character separator, which is used to separate data fields of variable length and application identifiers of subsequent data fields in concatenated data strings.	None
Security Level	Select the security level from Level 0 to Level 3	Level 1
Korean 3 OF 5		
Korean 3 of 5		Disable
Korean 3 of 5	Switch to enable Korean 3 of 5 decoding.	Disable
MSI		
MSI		Enable
MSI	Switch to enable MSI decoding.	Enable
Length option	<p>Sets the length of the MSI symbols to decode.</p> <ul style="list-style-type: none"> ▶ One Fixed length (Length 1) ▶ Two Fixed lengths (Length 1>Length 2) ▶ Max / Min Length (range: 0-55; Length 1<Length 2) ▶ Any Length 	Max / Min Length (4-55)

Symbology	Description	Default
Verify Check Digit	<p>One check digit is mandatory for decoding MSI barcodes. Select whether a second check digit should be verified. If the check digits are incorrect, the barcode will not be accepted.</p> <ul style="list-style-type: none"> ▶ One Check Digit ▶ Two Check Digits 	One Check Digit
Transmit Check Digit	Decide whether to include the check digit in the data to transmit.	Disable
Algorithm	<p>When two check digits are set for verification, two choices are available for the pair of check digits.</p> <ul style="list-style-type: none"> ▶ Modulo10 / Modulo11 ▶ Double Modulo 10 	Double Modulo 10
Postal		
Australian Postal		Enable
Japan Postal		Enable
Netherlands KIX Code		Enable
US Postnet		Enable
US Planet		Enable
USPS Postal		Enable
UPU FICS Postal		Enable
UK Postal		Enable
Postal General Preference		
US Postal Check Digit	Decide whether to transmit check digit for US Postnet or US Planet.	Enable
UK Postal Check Digit	Decide whether to transmit check digit for UK Postal.	Enable

Symbology	Description	Default
EAN		
EAN-8		Enable
EAN-8	Switch to enable EAN-8 decoding.	Enable
Addon 2	Decide whether to decode EAN-8 with addon 2. <ul style="list-style-type: none"> ▶ Ignore Addon ▶ Auto-discriminate 	Ignore Addon
Addon 5	Decide whether to decode EAN-8 with addon 5. <ul style="list-style-type: none"> ▶ Ignore Addon ▶ Auto-discriminate 	Ignore Addon
Transmit Check Digit	Decide whether to include the check digit in the data to transmit.	Enable
Convert to EAN-13	Decide whether to enable converting EAN-8 to EAN-13 format.	Disable
EAN-13		Enable
EAN-13	Switch to enable EAN-13 decoding.	Enable
Bookland EAN	Switch to enable Bookland EAN decoding.	Disable
Bookland ISBN Format	Decodes Bookland data starting with 978 in 10-digit format along with the Bookland check digit, or Bookland data starting with 978/979 in 13-digit format.	Bookland ISBN-10
Addon 2	Decide whether to decode EAN-13 with addon 2. <ul style="list-style-type: none"> ▶ Ignore Addon ▶ Auto-discriminate 	Ignore Addon
Addon 5	Decide whether to decode EAN-13 with addon 5. <ul style="list-style-type: none"> ▶ Ignore Addon ▶ Auto-discriminate 	Ignore Addon
Transmit Check Digit	Decide whether to include the check digit in the data to transmit.	Enable
ISSN EAN	Switch to enable ISSN EAN decoding.	Disable



Symbology	Description	Default
UPC		
UPC-A		Enable
UPC-A	Switch to enable UPC-A decoding.	Enable
Addon 2	Decide whether to decode UPC-A with addon 2. <ul style="list-style-type: none"> ▶ Ignore Addon ▶ Auto-discriminate 	Ignore Addon
Addon 5	Decide whether to decode UPC-A with addon 5. <ul style="list-style-type: none"> ▶ Ignore Addon ▶ Auto-discriminate 	Ignore Addon
Preamble	Decide whether to include the UPC-A preamble System Character (and Country Code) in the data being transmitted. <ul style="list-style-type: none"> ▶ No transmit: transmits none of the above ▶ Transmit System Character: transmits system number only ▶ Transmit Sys. Character and Country Code: transmits system number and country code 	Transmit System Character
Transmit Check Digit	Decide whether to include the UPC-A check digit (the last character in the barcode) in the data being transmitted.	Enable
Convert to EAN-13	Checkbox to enable converting EAN-8 to EAN-13 format.	Disable
UPC-E		Enable
UPC-E	Switch to enable UPC-E decoding.	Enable
Addon 2	Decide whether to decode UPC-E with addon 2. <ul style="list-style-type: none"> ▶ Ignore Addon ▶ Auto-discriminate 	Ignore Addon

Symbology	Description	Default
Addon 5	Decide whether to decode UPC-E with addon 5. <ul style="list-style-type: none"> ▶ Ignore Addon ▶ Auto-discriminate 	Ignore Addon
Preamble	Decide whether to include the UPC-E preamble System Character (and Country Code) in the data being transmitted. <ul style="list-style-type: none"> ▶ No transmit: transmits none of the above ▶ Transmit System Character: transmits system number only 	Transmit System Character
Conver to UPC-A	The UPC-E barcode will be expanded into UPC-A format, and the next process will follow the settings configured for UPC-A.	Disable
Transmit Check Digit	Decide whether to include the UPC-E check digit (the last character in the barcode) in the data being transmitted.	Enable
UPC-E1		Disable
UPC-E1	Switch to enable UPC-E1 decoding.	Disable
Addon 2	Decide whether to decode UPC-E1 with addon 2. <ul style="list-style-type: none"> ▶ Ignore Addon ▶ Auto-discriminate 	Ignore addon
Addon 5	Decide whether to decode UPC-E1 with addon 5. <ul style="list-style-type: none"> ▶ Ignore Addon ▶ Auto-discriminate 	Ignore addon
Preamble	Decide whether to include the UPC-E1 preamble System Character (and Country Code) in the data being transmitted. <ul style="list-style-type: none"> ▶ No transmit: transmits none of the above ▶ Transmit System Character: transmits system number only ▶ Transmit Sys. Character and Country Code: transmits system number and country code 	Transmit System Character

Symbology	Description	Default
Convert to UPC-A	The UPC-E1 barcode will be expanded into UPC-A format, and the next process will follow the settings configured for UPC-A.	Disable
Transmit Check Digit	Decide whether to include the UPC-E1 check digit (the last character in the barcode) in the data being transmitted.	Enable
Coupon Code		
Goupon Code		Disable
Coupon Code	Switch to enable Coupon Code decoding.	Disable

2D SYMBOLOGIES

Symbology	Description	Default
Aztec		
Aztec		Enable
Aztec	Switch to enable Aztec decoding.	Enable
Data Matrix		
Data Matrix		Enable
Data Matrix	Switch to enable Data Matrix decoding.	Enable
Decode Mirror Image	<p>Switch to enable decode mirror images.</p> <ul style="list-style-type: none"> ▶ Never: Does not decode Data Matrix barcodes that are mirror images. ▶ Always: Decodes Data Matrix barcodes that are mirror images. ▶ Auto-discriminate: Decodes both mirrored and unmirrored Data Matrix barcodes. 	Never
Separator Character	<p>Enable the function code character separator, which is used to separate data fields of variable length and application identifiers of subsequent data fields in concatenated data strings.</p> <p>Tap on  to choose your input method between Keyboard input and Symbol table input to set a separator character to replace with.</p>	None

Symbology	Description	Default
Enable App ID Separator	<p>Check to enable the separator configuration for Application Identifier.</p>  <p>You can respectively set the Left Separator and Right Separator. Tap on  to choose your input method between Keyboard input and Symbol table input to set a separator character to replace with.</p>	Disable
MaxiCode		
MaxiCode		Enable
MaxiCode	Switch to enable MaxiCode decoding.	Enable
MicroPDF417		
MicroPDF417		Disable
MicroPDF417	Switch to enable MicroPDF417 decoding.	Disable
Code 128 Emulation	<p>Transmit data from certain Micro PDF 417 barcodes as if it was encoded in Code 128 barcodes.</p> <p>Note: Transmit AIM code ID character in “Scanner Preferences” must be enabled first. When applied, the MicroPDF417 barcodes are transmitted with one of these prefixes:</p> <ul style="list-style-type: none"> ▶ The first codeword of MicroPDF417 is 903-905: The original Code ID "]L3" will be changed to "]C1". ▶ The first codeword of MicroPDF417 is 908 or 909: The original Code ID "]L4" will be changed to "]C2". ▶ The first codeword of MicroPDF417 is 910 or 911: The original Code ID "]L5" will be changed to "]C0". 	Disable

Symbology	Description	Default
MicroQR		
MicroQR		Enable
MicroQR	Switch to enable MicroQR decoding.	Enable
PDF417		
PDF417		Enable
PDF417	Switch to enable PDF417 decoding.	Enable
QR Code		
QR Code		Enable
QR Code	Switch to enable QR Code decoding.	Enable
MRZ		
MRZ		Disable
MRZ	Switch to enable MRZ decoding.	Disable
MRZ Mode	Tap to select: <ul style="list-style-type: none"> ▶ OCR-B Travel Documents Version 1 (3-Line ID Cards) ▶ OCR-B Travel Documents Version 2 (2-Line ID Cards) ▶ OCR-B Travel Documents 2 or 3-Line ID Cards Auto-Detect ▶ OCR-B Passport ▶ OCR-B Visa Type A ▶ OCR-B Visa Type B ▶ OCR-B ICAO Travel Documents 	OCR-B ICAO Travel Documents

Symbology	Description	Default
Dot Code		
Dot Code		Disable
Dot Code	Switch to enable Dot Code decoding.	Disable
Decode Mirror Image	Switch to enable decode mirror images. <ul style="list-style-type: none"> ▶ Never: Does not decode Dot Code barcodes that are mirror images. ▶ Always: Decodes Dot Code barcodes that are mirror images. ▶ Auto-discriminate: Decodes both mirrored and unmirrored Dot Code barcodes. 	Never
Inverse Type	Select to decode regular barcodes, inverse barcodes, or set as auto.	Regular only
Prioritize	As Dot Code is the most barcode to be read, it is suggest to enable "Prioritize" for batter performance.	Disable



SM4 + SDC

1D SYMBOLOGIES

Symbology	Description	Default
CODABAR		
Codabar		Enable
Codabar	Switch to enable Codabar decoding.	Enable
Length Option	<p>Set the length of the Codabar symbols to decode.</p> <ul style="list-style-type: none"> ▶ One Fixed length (Length 1) ▶ Two Fixed lengths (Length 1>Length 2) ▶ Max / Min Length (range: 0-55; Length 1<Length 2) ▶ Any Length 	Max / Min Length (4-55)
CLSI Editing	<p>When applied, the CLSI editing strips the start/stop characters and inserts a space after the first, fifth, and tenth characters of a 14-character Codabar barcode.</p> <ul style="list-style-type: none"> ▶ The 14-character barcode length does not include start/stop characters. 	Disable
NOTIS Editing	<p>Set whether to include start/stop characters in the transmitted data.</p> <ul style="list-style-type: none"> ▶ NOTIS Editing is to strip the start/stop characters, i.e. to disable "Transmit Start/Stop Characters". 	Disable
NOTIS Editing Type	<p>Options are None, ABCD/ABCD, abcd/abcd.</p> <ul style="list-style-type: none"> ▶ "NOTIS Editing" must be enabled. 	None
Verify Check Digit	Select whether to verify the Modulo 43 check digit. If the check digit is incorrect, the barcode will not be accepted.	None
Transmit Check Digit	<p>Decide whether to include the check digit in the data to transmit.</p> <ul style="list-style-type: none"> ▶ "Verify Check Digit" must be enabled. 	Enable

Symbology	Description	Default
CODE 11		
Code 11		Enable
Code 11	Switch to enable Code 11 decoding.	Enable
Check Digit Option	Set whether to verify check digits according to the selected option. If the check digits are incorrect, the barcode will not be accepted. <ul style="list-style-type: none"> ▶ Disable ▶ One Check Digit ▶ Two Check Digit 	Disable
Transmit Check Digit	Selects whether to include check digits in the transmitted data. <ul style="list-style-type: none"> ▶ Check Digit Option” must be enabled. 	Disable
Length option	Sets the length of the Code 11 symbols to decode. <ul style="list-style-type: none"> ▶ One Fixed length (Length 1) ▶ Two Fixed lengths (Length 1>Length 2) ▶ Max / Min Length (range: 0-55; Length 1<Length 2) ▶ Any Length 	Max / Min Length (4-55)
CODE 39		
Code 39		Enable
Code 39	Switch to enable Code 39 decoding.	Enable
Convert to Code 32	Selects whether to convert decoded data to Italian Pharmacode.	Disable
Code 32 Prefix	Prefix character “A” to Code 32 barcodes. <ul style="list-style-type: none"> ▶ “Convert to Code 32” must be enabled for this to function properly. 	Disable
Verify Check Digit	Selects whether to verify the Modulo 43 check digit. If the check digit is incorrect, the barcode will not be accepted.	Disable

Symbology	Description	Default
Transmit Check Digit	Decide whether to include the check digit in the data to transmit. <ul style="list-style-type: none"> ▶ “Verify Check Digit” must be enabled. 	Disable
Support Full ASCII	Selects whether to enable Code 39 Full ASCII decoding. Characters are paired to encode the full ASCII character set.	Disable
Length option	Sets the length of the Code 39 symbols to decode. <ul style="list-style-type: none"> ▶ One Fixed length (Length 1) ▶ Two Fixed lengths (Length 1>Length 2) ▶ Max / Min Length (range: 0-55; Length 1<Length 2) ▶ Any Length 	Max / Min Length (4-55)
Security Level	Select the security level from Level 0 to Level 3	Level 0
TRIOPTIC CODE 39		
Trioptic Code 39		Disable
Trioptic Code 39	Switch to enable Trioptic Code 39 decoding.	Disable
CODE 93		
Code 93		Enable
Code 93	Switch to enable Code 93 decoding.	Enable
Length option	Sets the length of the Code 93 symbols to decode. <ul style="list-style-type: none"> ▶ One Fixed length (Length 1) ▶ Two Fixed lengths (Length 1>Length 2) ▶ Max / Min Length (range: 0-55; Length 1<Length 2) ▶ Any Length 	Max / Min Length (4-55)
CODE 128		
Code 128		Enable
Code 128	Switch to enable Code 128 decoding.	Enable

Symbology	Description	Default
Length option	<p>Sets the length of the Code 128 symbols to decode.</p> <ul style="list-style-type: none"> ▶ One Fixed length (Length 1) ▶ Two Fixed lengths (Length 1>Length 2) ▶ Max / Min Length (range: 0-55; Length 1<Length 2) ▶ Any Length 	Max / Min Length (0-55)
Security Level	Select the security level from Level 0 to Level 3 .	Level 1
GS1-128		Enable
GS1-128	Switch to enable GS1-128 decoding.	Enable
Separator Character	<p>Enable the function code character separator, which is used to separate data fields of variable length and application identifiers of subsequent data fields in concatenated data strings.</p> <p>Tap on  to choose your input method between Keyboard input and Symbol table input to set a separator character to replace with.</p>	None
Enable App ID Separator	<p>Check to enable the separator configuration for Application Identifier.</p>  <p>You can respectively set the Left Separator and Right Separator. Tap on  to choose your input method between Keyboard input and Symbol table input to set a separator character to replace with.</p>	Disable
ISBT 128		Enable
ISBT 128	Switch to enable ISBT 128 decoding.	Enable

Symbology	Description	Default
Concatenation	<p>Sets whether to enable decoding ISBT 128 by performing concatenation of ISBT data.</p> <ul style="list-style-type: none"> ▶ Disable: Does not perform concatenation ▶ Enable: Performs concatenation on all ISBT-128 barcodes. ▶ Auto-discriminate: Auto-discriminates between the ISBT 128 barcodes which require concatenation and those which do not need concatenation. 	Disable
Redundancy	When “Auto-discriminate” is applied, decide the number of times of supplementary decoding the same barcode to count as a valid read. Configurable between 2 and 20.	10
Chinese 25		
Chinese 25		Enable
Chinese 25	Switch to enable Chinese 2 of 5 decoding.	Enable
Discrete 25		
Discrete 25		Enable
Discrete 25	Switch to enable Discrete 2 of 5 decoding.	Enable
Length option	<p>Sets the length of the Discrete 2 of 5 symbols to decode.</p> <ul style="list-style-type: none"> ▶ One Fixed length (Length 1) ▶ Two Fixed lengths (Length 1>Length 2) ▶ Max / Min Length (range: 4-55; Length 1<Length 2) ▶ Any Length 	Max / Min Length (4-55)
Interleaved 25		
Interleaved 25		Enable
Interleaved 25	Switch to enable Interleaved 2 of 5 decoding.	Enable

Symbology	Description	Default
Length option	<p>Sets the length of Interleaved 2 of 5 symbols to decode.</p> <ul style="list-style-type: none"> ▶ One Fixed length (Length 1) ▶ Two Fixed lengths (Length 1>Length 2) ▶ Max / Min Length (range: 4-55; Length 1<Length 2) ▶ Any Length 	Max / Min Length (4-55)
Verify Check Digit	Decide whether to verify the check digit. If the check digit is incorrect, the barcode will not be accepted.	Disable
Transmit Check Digit	Decide whether to include the check digit in the data to transmit.	Disable
Convert to EAN-13	<p>Convert a 14-character Interleaved 25 barcode into EAN-13 if the following requirements are met:</p> <ul style="list-style-type: none"> ▶ The barcode must have a leading 0 and a valid EAN-13 check digit. 	Disable
Security Level	Select the security level from Level 0 to Level 3	Level 1
Matrix 25		
Matrix 25		Enable
Matrix 25	Switch to enable Matrix 2 of 5 decoding.	Enable
Length option	<p>Sets the length of the Matrix 2 of 5 symbols to decode.</p> <ul style="list-style-type: none"> ▶ One Fixed length (Length 1) ▶ Two Fixed lengths (Length 1>Length 2) ▶ Max / Min Length (range: 4-55; Length 1<Length 2) ▶ Any Length 	Max / Min Length (4-55)
Redundancy	Enables or disable read redundancy for Matrix 2 of 5.	Disable
Verify Check Digit	Decide whether to verify the check digit. If the check digit is incorrect, the barcode will not be accepted.	Disable
Transmit Check Digit	Decide whether to include the check digit in the data to transmit.	Disable

Symbology	Description	Default
Composite		
Composite CC-A/B		Disable
Composite CC-A/B	Switch to enable Composite CC-A/B decoding.	Disable
Composite CC-C		Enable
Composite CC-C	Switch to enable Composite CC-C decoding.	Enable
Composite TLC-39		Disable
Composite TLC-39	Switch to enable Composite TLC-39 decoding.	Disable
Composite General Preference		
UPC Composite Mode	<p>UPC barcodes can be "linked" with a 2D barcode during transmission as if they were one barcode.</p> <ul style="list-style-type: none"> ▶ UPC Never Linked: Transmit UPC barcodes regardless of whether a 2D barcode is detected. ▶ UPC Always Linked: Transmit UPC barcodes and the 2D portion. If the 2D portion is not detected, the UPC barcode will not be transmitted. <p>Note: CC-A/B or CC-C must be enabled.</p> <ul style="list-style-type: none"> ▶ Auto-discriminate: <p>Transmit UPC barcodes as well as the 2D portion if present.</p>	UPC always Linked
GS1-128 Emulation Mode	Sets GS1-128 emulation mode for UCC/EAN Composite Codes.	Disable
GS1 DataBar		
GS1 DataBar-14		Enable
GS1 DataBar-14	Switch to enable GS1 DataBar-14 decoding.	Enable
Convert to UPC/EAN	Strips the leading '010' of GS1 DataBar and converts the barcode to EAN-13.	Disable
Security Level	Select the security level from Level 0 to Level 3	Level 1

Symbology	Description	Default
GS1 DataBar Limited		Enable
GS1 DataBar Limited	Switch to enable GS1 DataBar Limited decoding.	Enable
Convert to UPC/EAN	Strips the leading '010' of GS1 DataBar and converts the barcode to EAN-13.	Disable
Security Level	Select the security level from Level 0 to Level 3	Level 3
GS1 DataBar Expanded		Enable
GS1 DataBar Expanded	Switch to enable GS1 DataBar Expanded decoding.	Enable
Separator Character	Separator Character Enable the function code character separator, which is used to separate data fields of variable length and application identifiers of subsequent data fields in concatenated data strings.	None
Security Level	Select the security level from Level 0 to Level 3	Level 1
Korean 3 OF 5		
Korean 3 of 5		Disable
Korean 3 of 5	Switch to enable Korean 3 of 5 decoding.	Disable
MSI		
MSI		Enable
MSI	Switch to enable MSI decoding.	Enable
Length option	Sets the length of the MSI symbols to decode. <ul style="list-style-type: none"> ▶ One Fixed length (Length 1) ▶ Two Fixed lengths (Length 1>Length 2) ▶ Max / Min Length (range: 4-55; Length 1<Length 2) ▶ Any Length 	Max / Min Length (4-55)

Symbology	Description	Default
Verify Check Digit	One check digit is mandatory for decoding MSI barcodes. Select whether a second check digit should be verified. If the check digits are incorrect, the barcode will not be accepted. <ul style="list-style-type: none"> ▶ One Check Digit ▶ Two Check Digits 	One Check Digit
Transmit Check Digit	Decide whether to include the check digit in the data to transmit.	Disable
Algorithm	When two check digits are set for verification, two choices are available for the pair of check digits. <ul style="list-style-type: none"> ▶ Modulo10 / Modulo11 ▶ Double Modulo 10 	Double Modulo 10
Postal		
Australian Postal		Enable
Japan Postal		Enable
Netherlands KIX Code		Enable
US Postnet		Enable
US Planet		Enable
USPS Postal		Enable
UPU FICS Postal		Enable
UK Postal		Enable
Postal General Preference		
US Postal Check Digit	Decide whether to transmit check digit for US Postnet or US Planet.	Enable
UK Postal Check Digit	Decide whether to transmit check digit for UK Postal.	Enable



Symbology	Description	Default
EAN		
EAN-8		Enable
EAN-8	Switch to enable EAN-8 decoding.	Enable
Addon 2	Decide whether to decode EAN-8 with addon 2. <ul style="list-style-type: none"> ▶ Ignore Addon ▶ Auto-discriminate 	Ignore Addon
Addon 5	Decide whether to decode EAN-8 with addon 5. <ul style="list-style-type: none"> ▶ Ignore Addon ▶ Auto-discriminate 	Ignore Addon
Transmit Check Digit	Decide whether to include the check digit in the data to transmit.	Enable
Convert to EAN-13	Decide whether to enable converting EAN-8 to EAN-13 format.	Disable
EAN-13		Enable
EAN-13	Switch to enable EAN-13 decoding.	Enable
Bookland EAN	Switch to enable Bookland EAN decoding.	Disable
Bookland ISBN Format	Decodes Bookland data starting with 978 in 10-digit format along with the Bookland check digit, or Bookland data starting with 978/979 in 13-digit format.	Bookland ISBN-10
Addon 2	Decide whether to decode EAN-13 with addon 2. <ul style="list-style-type: none"> ▶ Ignore Addon ▶ Auto-discriminate 	Ignore Addon
Addon 5	Decide whether to decode EAN-13 with addon 5. <ul style="list-style-type: none"> ▶ Ignore Addon ▶ Auto-discriminate 	Ignore Addon
Transmit Check Digit	Decide whether to include the check digit in the data to transmit.	Enable
ISSN EAN	Switch to enable ISSN EAN decoding.	Disable

Symbology	Description	Default
UPC		
UPC-A		Enable
UPC-A	Switch to enable UPC-A decoding.	Enable
Addon 2	Decide whether to decode UPC-A with addon 2. <ul style="list-style-type: none"> ▶ Ignore Addon ▶ Auto-discriminate 	Ignore Addon
Addon 5	Decide whether to decode UPC-A with addon 5. <ul style="list-style-type: none"> ▶ Ignore Addon ▶ Auto-discriminate 	Ignore Addon
Preamble	Decide whether to include the UPC-A preamble System Character (and Country Code) in the data being transmitted. <ul style="list-style-type: none"> ▶ No transmit: transmits none of the above ▶ Transmit System Character: transmits system number only ▶ Transmit Sys. Character and Country Code: transmits system number and country code 	Transmit System Character
Transmit Check Digit	Decide whether to include the UPC-A check digit (the last character in the barcode) in the data being transmitted.	Enable
Convert to EAN-13	Checkbox to enable converting EAN-8 to EAN-13 format.	Disable
UPC-E		Enable
UPC-E	Switch to enable UPC-E decoding.	Enable
Addon 2	Decide whether to decode UPC-E with addon 2. <ul style="list-style-type: none"> ▶ Ignore Addon ▶ Auto-discriminate 	Ignore Addon
Addon 5	Decide whether to decode UPC-E with addon 5. <ul style="list-style-type: none"> ▶ Ignore Addon ▶ Auto-discriminate 	Ignore Addon

Symbology	Description	Default
Preamble	<p>Decide whether to include the UPC-E preamble System Character (and Country Code) in the data being transmitted.</p> <ul style="list-style-type: none"> ▶ No transmit: transmits none of the above ▶ Transmit System Character: transmits system number only ▶ Transmit Sys. Character and Country Code: transmits system number and country code 	Transmit System Character
Conver to UPC-A	The UPC-E barcode will be expanded into UPC-A format, and the next process will follow the settings configured for UPC-A.	Disable
Transmit Check Digit	Decide whether to include the UPC-E check digit (the last character in the barcode) in the data being transmitted.	Enable
UPC-E1		Disable
UPC-E1	Switch to enable UPC-E1 decoding.	Disable
Addon 2	<p>Decide whether to decode UPC-E1 with addon 2.</p> <ul style="list-style-type: none"> ▶ Ignore Addon ▶ Auto-discriminate 	Ignore addon
Addon 5	<p>Decide whether to decode UPC-E1 with addon 5.</p> <ul style="list-style-type: none"> ▶ Ignore Addon ▶ Auto-discriminate 	Ignore addon
Preamble	<p>Decide whether to include the UPC-E1 preamble System Character (and Country Code) in the data being transmitted.</p> <ul style="list-style-type: none"> ▶ No transmit: transmits none of the above ▶ Transmit System Character: transmits system number only ▶ Transmit Sys. Character and Country Code: transmits system number and country code 	Transmit System Character
Convert to UPC-A	The UPC-E1 barcode will be expanded into UPC-A format, and the next process will follow the settings configured for UPC-A.	Disable

Symbology	Description	Default
Transmit Check Digit	Decide whether to include the UPC-E1 check digit (the last character in the barcode) in the data being transmitted.	Enable
Coupon Code		
Goupon Code		Disable
Coupon Code	Switch to enable Coupon Code decoding.	Disable

2D SYMBOLOGIES















Symbology	Description	Default
Aztec		
Aztec		Enable
Aztec	Switch to enable Aztec decoding.	Enable
Data Matrix		
Data Matrix		Enable
Data Matrix	Switch to enable Data Matrix decoding.	Enable
Decode Mirror Image	<p>Switch to enable decode mirror images.</p> <ul style="list-style-type: none"> ▶ Never: Does not decode Data Matrix barcodes that are mirror images. ▶ Always: Decodes Data Matrix barcodes that are mirror images. ▶ Auto-discriminate: Decodes both mirrored and unmirrored Data Matrix barcodes. 	Never
Separator Character	Enable the function code character separator, which is used to separate data fields of variable length and application identifiers of subsequent data fields in concatenated data strings.	None
Enable App ID Separator	<p>Check to enable the separator configuration for Application Identifier.</p>  <p>You can respectively set the Left Separator and Right Separator. Tap on  to choose your input method between Keyboard input and Symbol table input to set a separator character to replace with.</p>	Disable

















Symbology	Description	Default
MaxiCode		
MaxiCode		Enable
MaxiCode	Switch to enable MaxiCode decoding.	Enable
MicroPDF417		
MicroPDF417		Disable
MicroPDF417	Switch to enable MicroPDF417 decoding.	Disable
Code 128 Emulation	<p>Transmit data from certain Micro PDF 417 barcodes as if it was encoded in Code 128 barcodes.</p> <p>Note: Transmit AIM code ID character in “Scanner Preferences” must be enabled first. When applied, the MicroPDF417 barcodes are transmitted with one of these prefixes:</p> <ul style="list-style-type: none"> ▶ The first codeword of MicroPDF417 is 903-905: The original Code ID "]L3" will be changed to "]C1". ▶ The first codeword of MicroPDF417 is 908 or 909: The original Code ID "]L4" will be changed to "]C2". ▶ The first codeword of MicroPDF417 is 910 or 911: The original Code ID "]L5" will be changed to "]C0". 	Disable
MicroQR		
MicroQR		Enable
MicroQR	Switch to enable MicroQR decoding.	Enable
PDF417		
PDF417		Enable
PDF417	Switch to enable PDF417 decoding.	Enable

Symbology	Description	Default
QR Code		
QR Code		Enable
QR Code	Switch to enable QR Code decoding.	Enable
Dot Code		
Dot Code		Disable
Dot Code	Switch to enable Dot Code decoding.	Disable
Decode Mirror Image	<p>Switch to enable decode mirror images.</p> <ul style="list-style-type: none"> ▶ Never: Does not decode Dot Code barcodes that are mirror images. ▶ Always: Decodes Dot Code barcodes that are mirror images. ▶ Auto-discriminate: Decodes both mirrored and unmirrored Dot Code barcodes. 	Never
Inverse Type	<p>Select to decode regular barcodes, inverse barcodes, or set as auto.</p> <ul style="list-style-type: none"> ▶ Regular only ▶ Inverse only ▶ Inverse Auto-detect 	Regular only
Prioritize	As Dot Code is the most barcode to be read, it is suggest to enable "Prioritize" for batter performance.	Disable

APPENDIX II

APPLICATION MENU

Icon	Name	Description
	AppLock	An application used to limit the system resources made available to users.
	BT Printer	An application which provide user interface to pair with Bluetooth printers.
	Button Assignment	The application “Button Assignment” can redefine the functions of physical keys so that they trigger different actions. Settings made to one or more keys can be saved as a profile, allowing users to switch conveniently in between different sets of settings.
	Calculator	Performs mathematical calculations.
	Calendar	Creates and manages events, meetings and appointments.
	Chrome	An Android built-in browser application developed by Google.
	Clock	Sets date, time, time zone according to your locale, and sets and manages alarms.
	Contacts	Manages contact information, and shares or exports/imports the information to other devices or SD card.
	Drive	An Android built-in application for a file storage and synchronization service created by Google.
	Duo	A one-to-one video call application developed by Google.
	Enterprise Settings	An application for “Doze Mode” settings of RS35 mobile computer.
	File	Browses and manages files on the local storage and storage card.
	Gmail	An Android built-in application for Gmail, a free email service provided by Google.
	Google	An Android built-in application providing you easy access to handy services provided by Google such as searching for nearby restaurants or updates on traffic alerts.
	HF RFID Configuration	An application for the configuration of RFID & NFC.

Icon	Name	Description
	Keep Notes	An Android built-in app which is a note-taking service developed by Google.
	Maps	An Android built-in app developed by Google.
	Messages	Sends SMS and MMS messages.
	Phone	Places and receives calls, accesses voicemail, views call history, manages phone contacts, and adjusts phone settings.
	Photos	An Android built-in application for a photo and video sharing and storage service developed by Google.
	Play Movies & TV	An Android built-in application for an online video on demand service operated by Google.
	Play Store	An Android built-in application providing access to a digital distribution service, including a digital media store, Play Store operated and developed by Google.
	Reader Config	Sets scanner preferences, data output format and destination, symbology settings, and reads barcodes.
	Settings	Opens settings to configure the mobile computer.
	Signature Capture	A simple and easy application which transforms your device into a signature pad.
	SIP Controller	An application for quickly open or close virtual keyboard by tapping on the floating button.
	Snapdragon Camera	Takes pictures and shoots videos.
	Software Trigger	An application serving as a real trigger key, floating on top of all other programs for convenient trigger control of the barcode scanner.
	Sound Recorder	Records and plays audio information.
	Terminal Emulation	The application is developed for industries which make extensive use of terminal emulators. It enables your mobile computer to act as a terminal emulator while communicating with a host of the same environment.
	YouTube	An Android built-in application for a video-sharing service.
	YT Music	A music streaming service application developed by YouTube. which allows users to browse through songs and music videos on YouTube.

APPENDIX III

OPEN SOURCE LICENSE

The Reader Config involves the android-serialport-api project of Apache License Version 2.0, January 2004.

<http://www.apache.org/licenses/>

TERMS AND CONDITIONS FOR USE, REPRODUCTION, AND DISTRIBUTION

1. Definitions.

"License" shall mean the terms and conditions for use, reproduction, and distribution as defined by Sections 1 through 9 of this document.

"Licensor" shall mean the copyright owner or entity authorized by the copyright owner that is granting the License.

"Legal Entity" shall mean the union of the acting entity and all other entities that control, are controlled by, or are under common control with that entity. For the purposes of this definition, "control" means (i) the power, direct or indirect, to cause the direction or management of such entity, whether by contract or otherwise, or (ii) ownership of fifty percent (50%) or more of the outstanding shares, or (iii) beneficial ownership of such entity.

"You" (or "Your") shall mean an individual or Legal Entity exercising permissions granted by this License.

"Source" form shall mean the preferred form for making modifications, including but not limited to software source code, documentation source, and configuration files.

"Object" form shall mean any form resulting from mechanical transformation or translation of a Source form, including but not limited to compiled object code, generated documentation, and conversions to other media types.

"Work" shall mean the work of authorship, whether in Source or Object form, made available under the License, as indicated by a copyright notice that is included in or attached to the work (an example is provided in the Appendix below).

"Derivative Works" shall mean any work, whether in Source or Object form, that is based on (or derived from) the Work and for which the editorial revisions, annotations, elaborations, or other modifications represent, as a whole, an original work of authorship. For the purposes of this License, Derivative Works shall not include works that remain separable from, or merely link (or bind by name) to the interfaces of, the Work and Derivative Works thereof.

"Contribution" shall mean any work of authorship, including the original version of the Work and any modifications or additions to that Work or Derivative Works thereof, that is intentionally submitted to Licensor for inclusion in the Work by the copyright owner or by an individual or Legal Entity authorized to submit on behalf of the copyright owner. For the purposes of this definition, "submitted" means any form of electronic, verbal, or written communication sent to the Licensor or its representatives, including but not limited to communication on electronic mailing lists, source code control systems, and issue tracking systems that are managed by, or on behalf of, the Licensor for the purpose of discussing and improving the Work, but excluding communication that is conspicuously marked or otherwise designated in writing by the copyright owner as "Not a Contribution."

"Contributor" shall mean Licensor and any individual or Legal Entity on behalf of whom a Contribution has been received by Licensor and subsequently incorporated within the Work.

2. Grant of Copyright License. Subject to the terms and conditions of this License, each Contributor hereby grants to You a perpetual, worldwide, non-exclusive, no-charge, royalty-free, irrevocable copyright license to reproduce, prepare Derivative Works of, publicly display, publicly perform, sublicense, and distribute the Work and such Derivative Works in Source or Object form.
3. Grant of Patent License. Subject to the terms and conditions of this License, each Contributor hereby grants to You a perpetual, worldwide, non-exclusive, no-charge, royalty-free, irrevocable (except as stated in this section) patent license to make, have made, use, offer to sell, sell, import, and otherwise transfer the Work, where such license applies only to those patent claims licensable by such Contributor that are necessarily infringed by their Contribution(s) alone or by combination of their Contribution(s) with the Work to which such Contribution(s) was submitted. If You institute patent litigation against any entity (including a cross-claim or counterclaim in a lawsuit) alleging that the Work or a Contribution incorporated within the Work constitutes direct or contributory patent infringement, then any patent licenses granted to You under this License for that Work shall terminate as of the date such litigation is filed.
4. Redistribution. You may reproduce and distribute copies of the Work or Derivative Works thereof in any medium, with or without modifications, and in Source or Object form, provided that You meet the following conditions:
 - a. You must give any other recipients of the Work or Derivative Works a copy of this License; and
 - b. You must cause any modified files to carry prominent notices stating that You changed the files; and
 - c. You must retain, in the Source form of any Derivative Works that You distribute, all copyright, patent, trademark, and attribution notices from the Source form of the Work, excluding those notices that do not pertain to any part of the Derivative Works; and

- d. If the Work includes a "NOTICE" text file as part of its distribution, then any Derivative Works that You distribute must include a readable copy of the attribution notices contained within such NOTICE file, excluding those notices that do not pertain to any part of the Derivative Works, in at least one of the following places: within a NOTICE text file distributed as part of the Derivative Works; within the Source form or documentation, if provided along with the Derivative Works; or, within a display generated by the Derivative Works, if and wherever such third-party notices normally appear. The contents of the NOTICE file are for informational purposes only and do not modify the License. You may add Your own attribution notices within Derivative Works that You distribute, alongside or as an addendum to the NOTICE text from the Work, provided that such additional attribution notices cannot be construed as modifying the License.

You may add Your own copyright statement to Your modifications and may provide additional or different license terms and conditions for use, reproduction, or distribution of Your modifications, or for any such Derivative Works as a whole, provided Your use, reproduction, and distribution of the Work otherwise complies with the conditions stated in this License.

5. **Submission of Contributions.** Unless You explicitly state otherwise, any Contribution intentionally submitted for inclusion in the Work by You to the Licensor shall be under the terms and conditions of this License, without any additional terms or conditions. Notwithstanding the above, nothing herein shall supersede or modify the terms of any separate license agreement you may have executed with Licensor regarding such Contributions.
6. **Trademarks.** This License does not grant permission to use the trade names, trademarks, service marks, or product names of the Licensor, except as required for reasonable and customary use in describing the origin of the Work and reproducing the content of the NOTICE file.
7. **Disclaimer of Warranty.** Unless required by applicable law or agreed to in writing, Licensor provides the Work (and each Contributor provides its Contributions) on an "AS IS" BASIS, WITHOUT WARRANTIES OR CONDITIONS OF ANY KIND, either express or implied, including, without limitation, any warranties or conditions of TITLE, NON-INFRINGEMENT, MERCHANTABILITY, or FITNESS FOR A PARTICULAR PURPOSE. You are solely responsible for determining the appropriateness of using or redistributing the Work and assume any risks associated with Your exercise of permissions under this License.

8. **Limitation of Liability.** In no event and under no legal theory, whether in tort (including negligence), contract, or otherwise, unless required by applicable law (such as deliberate and grossly negligent acts) or agreed to in writing, shall any Contributor be liable to You for damages, including any direct, indirect, special, incidental, or consequential damages of any character arising as a result of this License or out of the use or inability to use the Work (including but not limited to damages for loss of goodwill, work stoppage, computer failure or malfunction, or any and all other commercial damages or losses), even if such Contributor has been advised of the possibility of such damages.

9. **Accepting Warranty or Additional Liability.** While redistributing the Work or Derivative Works thereof, You may choose to offer, and charge a fee for, acceptance of support, warranty, indemnity, or other liability obligations and/or rights consistent with this License. However, in accepting such obligations, You may act only on Your own behalf and on Your sole responsibility, not on behalf of any other Contributor, and only if You agree to indemnify, defend, and hold each Contributor harmless for any liability incurred by, or claims asserted against, such Contributor by reason of your accepting any such warranty or additional liability.

END OF TERMS AND CONDITIONS