

AMX-2DN1 回路図

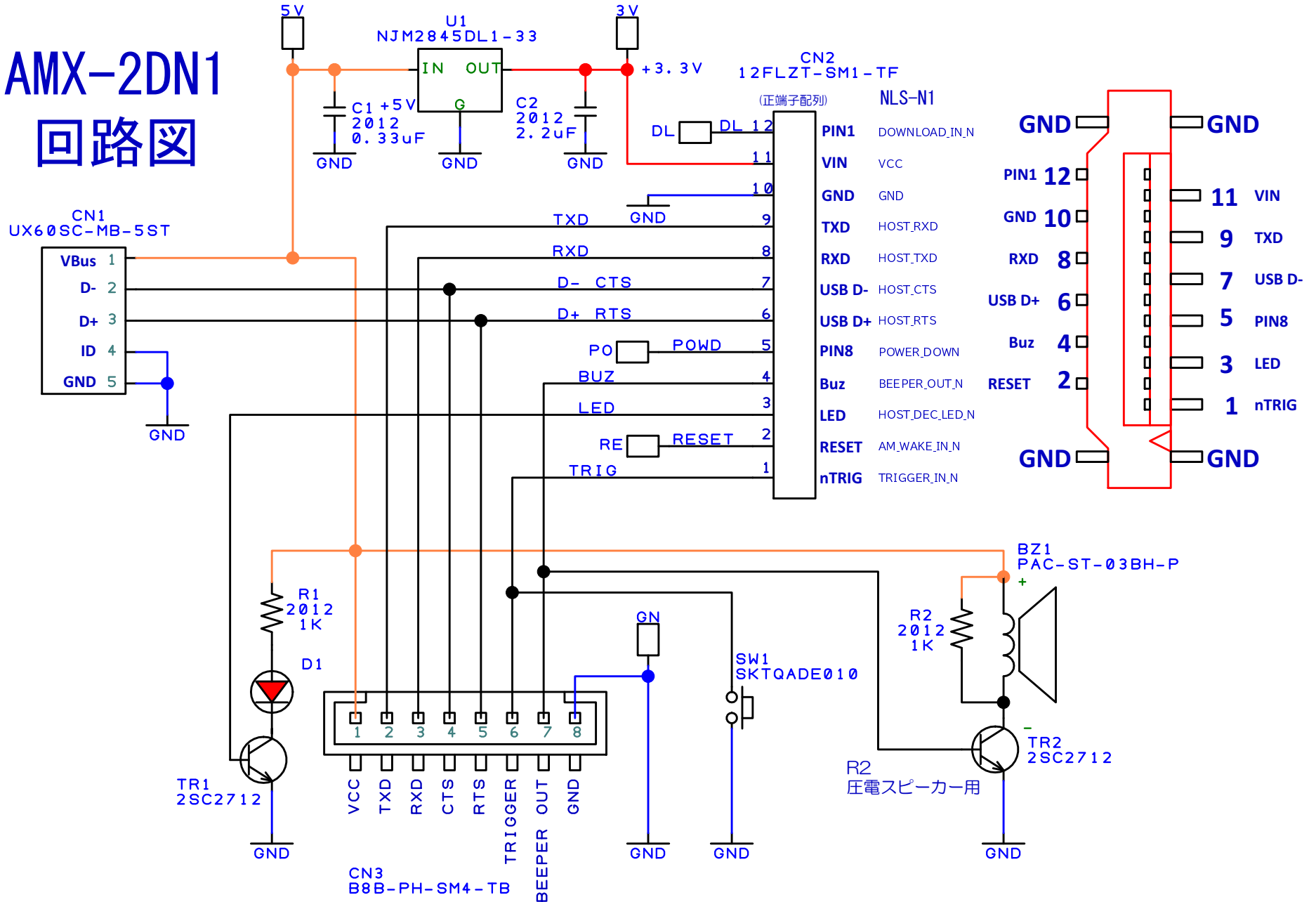

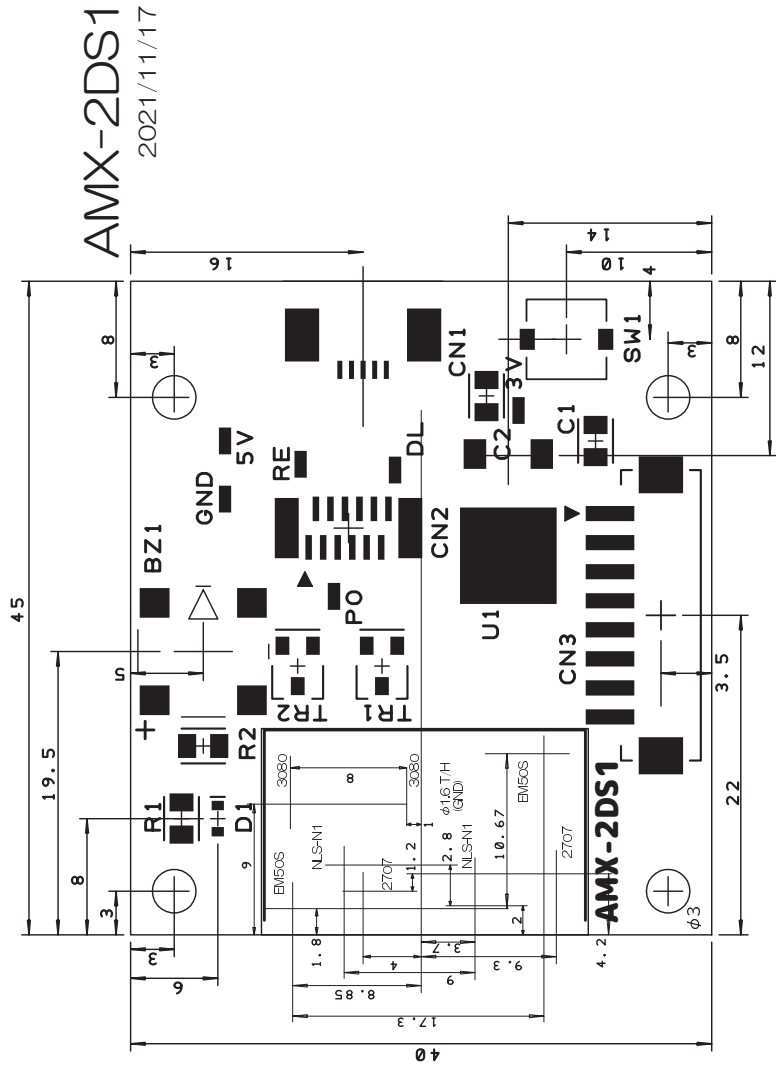

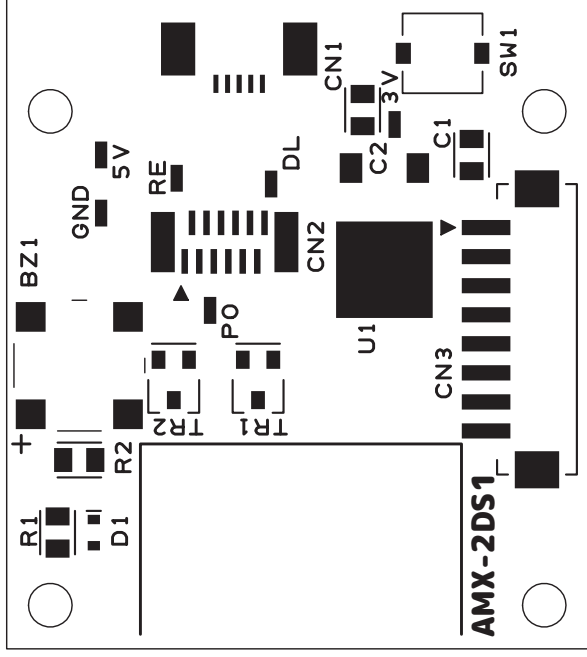
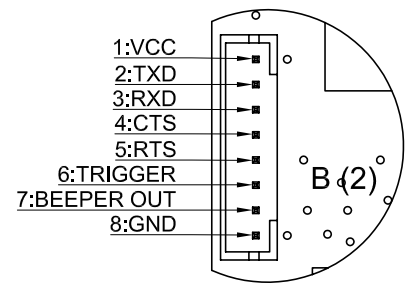
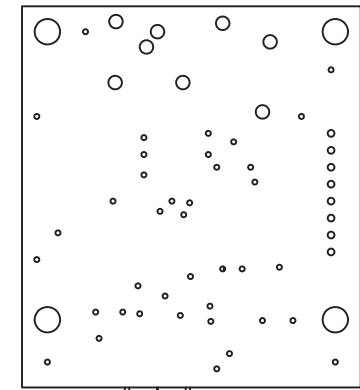
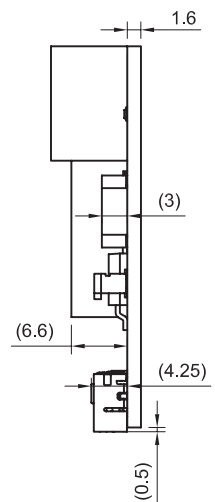
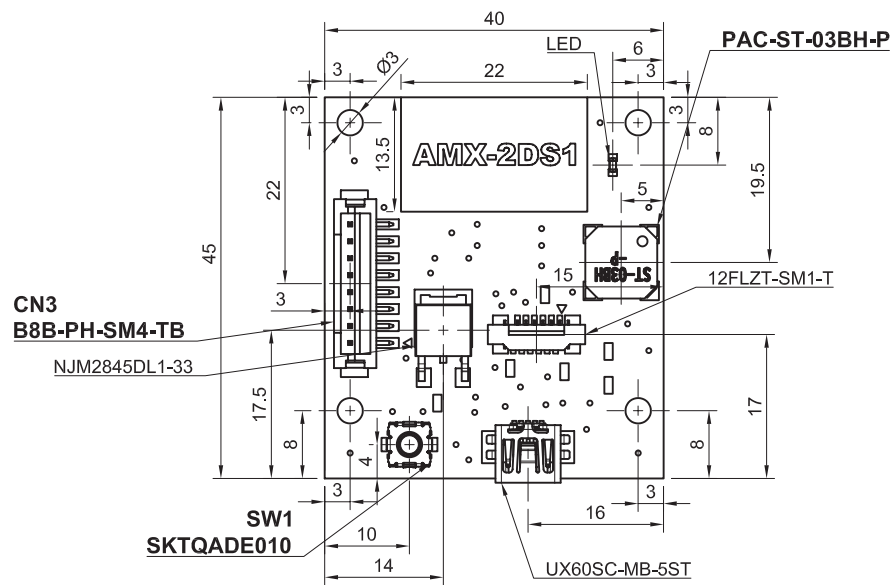

CN3 ピンアサイン

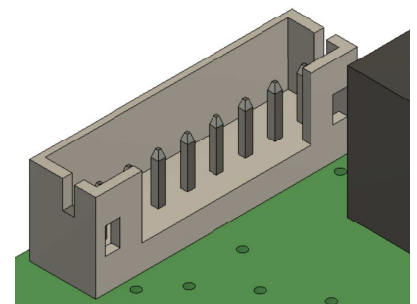

B8B-PH-K-S
CN3 実装イメージ

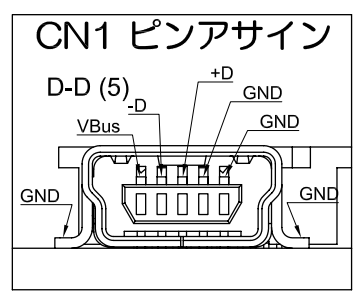

UX60SC-MB-5ST

部品変更概要

SW1	タクトスイッチ	SKTQADE010
CN3	PHコネクタ	B8B-PH-SM4-TB
BZ1	ブザー	PAC-ST-03BH

Title AMX-2DS1		
部品概要		
Rev.	Date of issue	Sheet
0	2021/11/16	1/1